

WILSONWERKS ARCHIVES

This camera manual is for reference and historical purposes, all rights reserved.

This cover page is copyrighted material. This document may not be sold or distributed without the express consent of the publisher.

©2008 wilsonwerks Llc

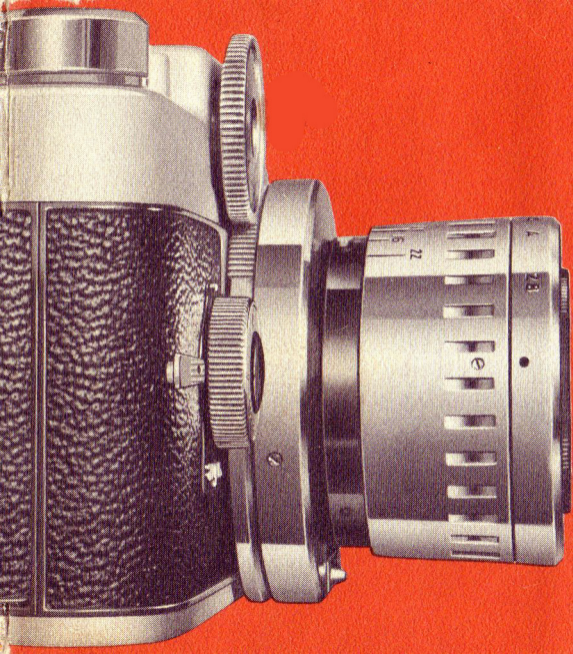

argus
C·44R



the versatile argus

C·44R

Your new camera is the perfect companion for every picture-taking opportunity. With its built-in rapid film wind and instantly interchangeable lens system, you'll never miss that once-in-a-lifetime picture.

The following pages describe the steps in picture-taking with the C44R. Read this instruction book carefully before you load the camera for the first time. If you're planning a trip or pictures of a special event, try a practice roll first to become completely familiar with the camera's operation.

CONTENTS:

Functional Parts.....	3, 4
Using the Rangefinder.....	5
Color-Matic Settings.....	6
Loading the Camera.....	7, 8
Unloading.....	8
Setting the Shutter.....	9
Setting the Lens.....	10
Outdoor Exposures.....	11, 12
Flash Pictures.....	13-15
Changing Lenses.....	16
Range of Sharpness.....	17
Specifications.....	18
Service Information.....	19
Care and Cleaning.....	20

functional parts

These are the important parts of your C44R. Be familiar with them as they are referred to throughout this book.

VIEWFINDER WINDOW

RANGEFINDER DIAL

REWIND CRANK

ACCESSORY SHOE

EXPOSURE COUNTER

FILM WIND LEVER

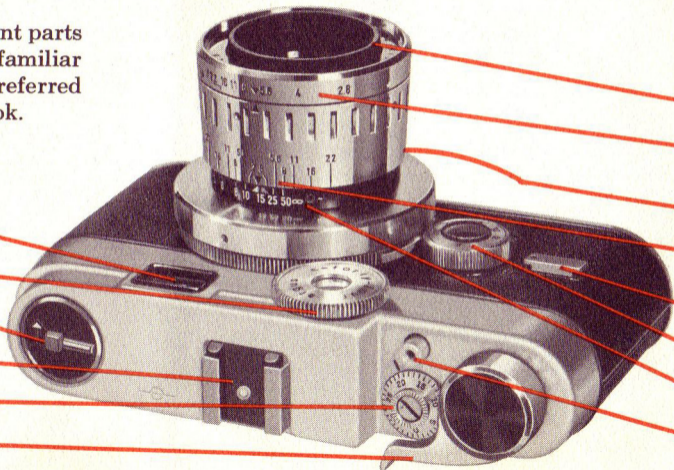

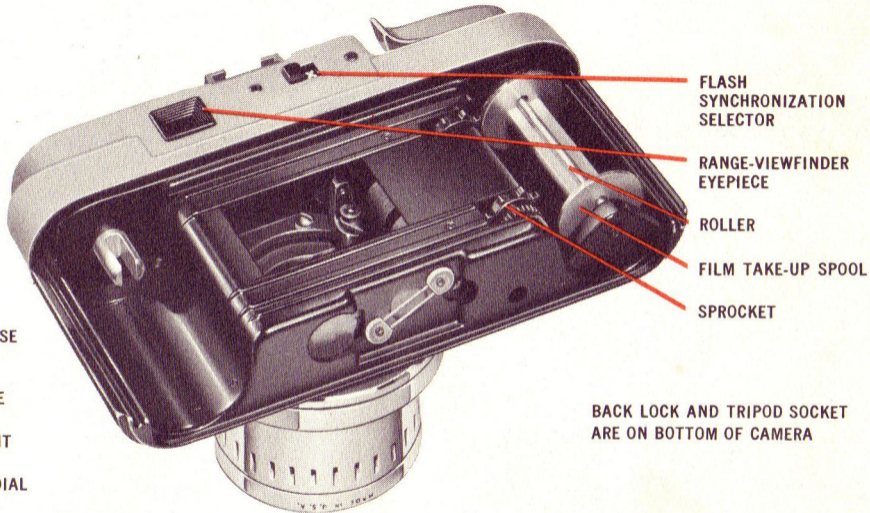

FLASH
SYNCHRONIZATION
SELECTOR

RANGE-VIEWFINDER
EYEPIECE

ROLLER

FILM TAKE-UP SPOOL

SPROCKET

BACK LOCK AND TRIPOD SOCKET
ARE ON BOTTOM OF CAMERA

FILTER RETAINER

LENS OPENING
SCALE

LENS-LOCK RELEASE

RANGE-OF-
SHARPNESS SCALE

CM2 METER MOUNT

SHUTTER SPEED DIAL

DISTANCE SCALE

SHUTTER RELEASE

The illustrations in this book may not show the latest minor changes in product appearance.

using the rangefinder

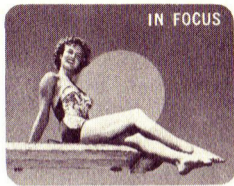
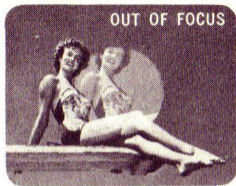

The combined viewfinder-rangefinder on the C44R makes focusing easy. Just sight through the viewfinder and turn the rangefinder dial with your finger until the images are aligned as shown in the illustrations.

A picture can be taken, as well as focused, with the camera in either a horizontal or vertical position. Hold the camera so the framing best suits the subject.

color-matic settings

Your C44R has a complete range of adjustments, but it can also be set and used as easily as a box camera. The lens opening and distance scales and the shutter speed dial have Color-matic markings for correct *outdoor* exposures for average subjects in bright sunlight.

YELLOW MARKINGS are used with Kodachrome.

RED MARKINGS are used with Anscochrome and Ektachrome Daylight color films, Kodacolor, and Panatomic-X or similar films (ASA 25-50).

The Color-matic distance setting is at 15 ft., but subjects between 9 and 50 ft. will be in focus. For subjects outside this range, focus with the range-finder (see page 5).

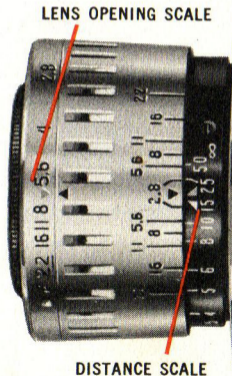
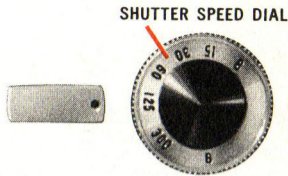

loading

Turn the lock (on camera bottom) to open and remove the back. Move the wind lever back and forth until it will go no further. Then rotate the take-up spool with your thumb until the flat side and the roller are facing up.

Insert a 35mm magazine in the camera and thread three perforations of film under the roller of the take-up spool. The film perforations should be engaged on the sprocket. Press the shutter re-

lease and move the wind lever until the end of the film lies back against the sprocket. See illustration below.

Place the back against the camera and slide it up into the closed position. Turn the lock to fasten the back.

Move the wind lever back and forth until it will go no further, press the shutter and move the lever through *two* full strokes. Press the shutter again.

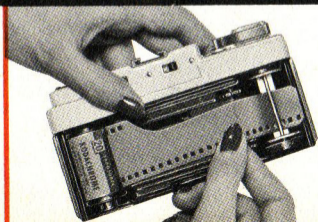
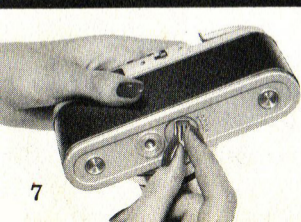

unloading

Set the exposure counter to 20 (for a 20 exposure roll) or to 36 (for a 36 exposure roll). The counter shows the exposures left.

You are now ready to wind the film for the first exposure. *Always* move lever through *two full strokes* to wind film.

When exposure counter reads "0" and you have taken that last picture, do not try to take any more. *Before camera is opened, film must be rewound.* To unfold the rewind crank, slide the red button toward the crank handle and let the crank pop up. Lift it out of the knob as shown in the illustration.

To rewind the film, hold the wind lever in toward the counter while you turn the crank in the direction of the arrow. Rewind until the counter stops moving, then a few more turns. Open the back, remove the film, and have the film processed promptly.

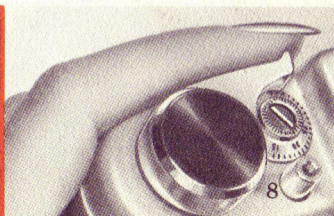
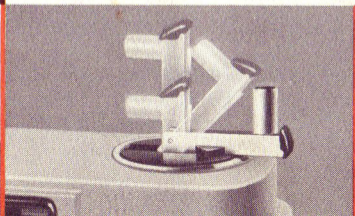
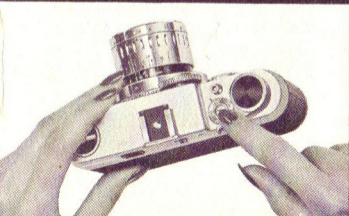

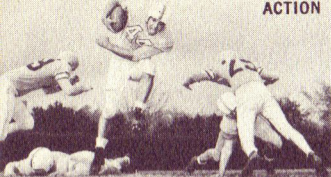

ACTION

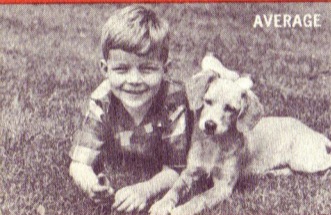

AVERAGE

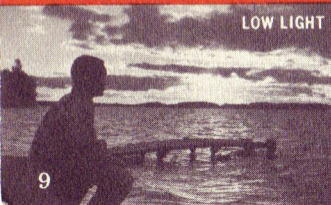

LOW LIGHT

setting the shutter



Turn the shutter speed dial until the desired number is exactly opposite the index mark, not in-between. The illustration shows a setting of 125 (1/125 second). The numbers are fractions of a second.

FOR ACTION PICTURES, use 1/125 or 1/300 second.

FOR AVERAGE PICTURES, use 1/60 or 1/125 second.

FOR LOW-LIGHT PICTURES, use 1/30 second or lower.

B is used for time exposures. When on B, the shutter will remain open as long as the release is held down. Use a cable release and tripod with speeds lower than 1/30 and when taking time exposures.

You set the lens opening by turning the lens opening scale to the right or left until the desired number is opposite the index mark. Lens openings may be set on or between the numbers.

THE CORRECT LENS OPENING TO USE for different films and lighting condi-

tions may be obtained by (1) using the Color-matic setting, (2) using the Outdoor Exposure Guide on page 12 or the Flash Exposure Guide on page 15, (3) using the data packed with your film or flashbulbs, or (4), the simplest of all for outdoor pictures, use the Argus Coupled Exposure Meter shown on page 22.

setting the lens



pictures outdoors

Beautiful outdoor pictures are easy with the C44R. The outdoor exposure guide on the opposite page gives you settings for different films and lighting conditions. You can also use the Color-matic settings on page 5, or the Argus Coupled Exposure Meter gives correct settings at a glance.

Check the picture composition through the camera viewfinder before snapping the shutter. This always results in pictures with more interest, and you will be certain you are not cutting off important parts of the subject. Try framing the scene with some nearby object in the foreground and add people in your picture to add human interest.



Close lens one stop (distance between numbers) from chart setting for *light subjects* (beach and snow scenes). Open one stop for dark subjects (foliage and dark flowers).

It is not always necessary to use the speeds in this chart. For instance, the chart may recommend 1/60 at f/8. To use 1/125, open the lens one stop to f/5.6 to compensate for the faster speed. If you wanted to use a speed half as fast (1/30), close the lens one stop (to f/11).

OUTDOOR EXPOSURE GUIDE

COLOR FILM	SHUTTER SPEED	Bright Sun	Hazy Sun	Cloudy Bright	Cloudy Dull
Ansochrome Daylight Ektachrome Daylight Kodacolor	60	f/11	f/8	f/5.6	f/4
Kodachrome Daylight (or indoor type*)	60	5.6-8	4-5.6	3.5	1/30 at 3.5
Ektachrome Type F*	60	8-11	5.6-8	4-5.6	3.5
Super Ansochrome Day.	125	16	11	8	5.6
BLACK AND WHITE					
Kodak Panatomic-X	60	11	8	5.6	4
Kodak Plus-X Pan	125	16	11	8	5.6
Anso Super Hypan	300	22	16	11	8
Kodak Tri-X Pan	300	16	11	8	5.6

*Filters are needed when using indoor-type color film outdoors. See the instructions packed with these films.

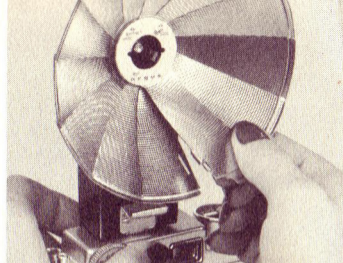
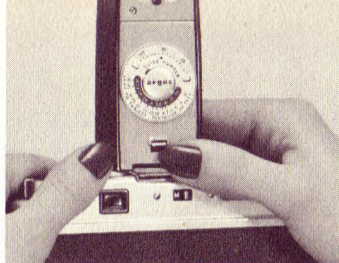
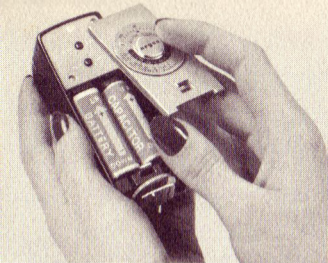

using the flash unit

To install a battery, lift up on the bottom of the back cover. Insert a 22.5V battery with the (+) positive end up (see specifications, page 18). Push battery in and replace the back.

To attach the unit to the camera, turn the knurled wheel up, slide the mounting foot into the flash shoe, then

tighten the wheel to lock the unit in place. Remove the front cover from the unit and set the lever (on top of unit) for the flashbulb you are using. Open the reflector by turning the top blade counterclockwise. Push flashbulbs straight into the socket. With bayonet-base bulbs, align pins on base with slots in socket.

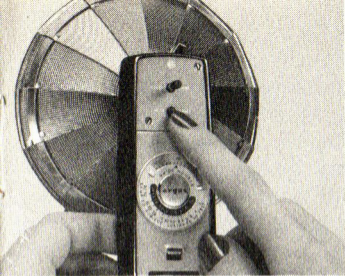

With a flashbulb in place, you can test the entire flash circuit and bulb with the **TEST LIGHT** button. If everything is working, the white spot above the **EJECT LAMP** button will flash briefly as the **TEST LIGHT** button is pressed.

THE FLASH CALCULATOR on the back of the unit tells you the lens opening to use.

(1) Turn the calculator dial to the guide number for your film and flashbulb (see chart on page 15). (2) Focus with your rangefinder to find the subject distance, then (3) look opposite this distance (on bottom of dial) to find the lens opening. Set this on your camera lens. For every subject distance it is necessary to use a different lens opening. Change the guide number whenever you change types of film or flashbulbs, or when you change shutter speeds.

THE EJECT LAMP BUTTON is pushed to eject the used flashbulb from the socket.

The flashbulb completes the unit's charging circuit. Do not leave bulb in place when storing unit.

FLASH EXPOSURE GUIDE

FILM FLASHBULBS	Sylvania M25	Sylvania M2	Sylvania Press 25 and Press M5		
	Use X sync. setting		Use M sync. setting		
SHUTTER SPEEDS	to 1/30	to 1/30	to 1/60	1/125	1/300
Ektachrome Type F Kodacolor	130	80	130	100	80
Kodachrome Type F	100	65	100	75	60
Ektachrome Daylight Anscochrome Daylight	Use blue flashbulbs with daylight color film				
	95	90*	95	75	55
Kodachrome Daylight	52	50*	52	42	30
Super Anscochrome Day.	170	160*	170	135	95
Kodak Tri-X Pan	320	220	320	250	190
Kodak Plus-X Pan	230	145	230	175	130
Kodak Panatomic-X	125	85	125	100	75
Anso Super Hypan	490	340	490	380	240

*Use this flashbulb (M2B) for outdoor fill-in flash only.

Flashbulbs occasionally shatter, and to avoid any possible damage, a translucent shield may be used over the flash unit reflector. Never use flash in an explosive atmosphere.

Set the camera's M-X synchronization selector for the bulb you are using. See chart. Guide numbers are intended as guides, and may be adjusted up or down. Remember to reset calculator to new guide number whenever you change shutter speeds, film, or bulbs.

Guide numbers for electronic flash units are furnished by the unit's manufacturer.

TO REMOVE A LENS, turn the rangefinder dial to set the lens at infinity (∞). Hold the camera in the left hand so that the body lens mount and the rangefinder dial are free to turn during the uncoupling operation. Hold the lens with the right hand (as shown) and push up on the lens-lock release as shown. Then give the lens a quarter-turn to the left (counterclockwise) and lift the lens out.

changing lenses

TO INSTALL ANY LENS, align the red dots on the body lens mount and align the red dots on the rear of the lens. Place the lens on the mount so the notch on the rear of the lens fits over the square projection on the camera mount. When seated, rotate the lens clockwise to lock. Check to see the lens is locked—it should not turn. Never leave the camera without a lens installed. Avoid changing lenses in direct sunlight.

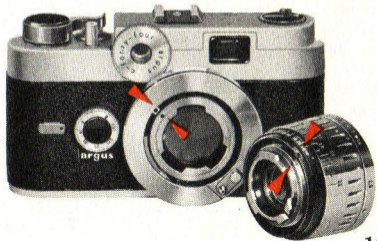
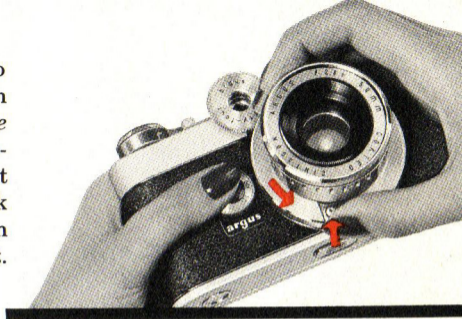

range of sharpness

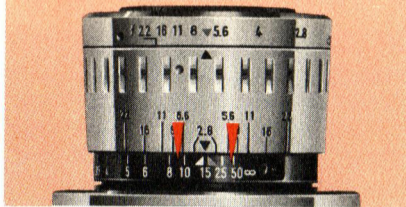

Even though you focus on a single subject, more than that subject will be sharp due to the “range of sharpness” or depth of field of your camera lens. The sharpness range extends both in front of and beyond the point focused upon. It depends on the lens opening and the focusing distance used.

To find the range you will have in a picture, first focus on the principal subject (with the rangefinder). Now look on both sides of the distance scale index mark for the lens opening you are using. Directly below these lens opening numbers are the near and far points of sharp focus.

Example: The illustration shows a lens opening of $f/6.3$ (between $f/8$ and $f/5.6$) and a focusing distance of 15 feet. Below $f/6.3$ on each side of the scale are the near and far points of sharp focus — about 9 feet to 50 feet.

specifications

LENS: 50mm f/2.8 or f/1.9 Argus Cintagon, color-corrected, coated; click-stop lens openings to f/22; rangefinder-coupled focusing; hyperfocal distance: 57'8" at f/2.8, 85' at f/1.9; field: 27 x 40 degrees angular at infinity.

SHUTTER: Behind-the-lens type, 6 speeds from 1/8 second to 1/300 second plus B; click-stop settings; cocking action coupled with the film wind; full M-X synchronization.

OTHER FEATURES: Die-cast metal body with leather grain and satin metal trim; automatic exposure counter; double exposure prevention; rapid film wind lever; rewind crank; mounting provisions for Argus CM2 Coupled Exposure Meter.

FILM SIZE: 35mm magazine (size 135), 20 or 36 exposure, color or b&w.

LENS ACCESSORIES: Standard lens has built-in retainer which unscrews to hold Series V filters and supplementary lenses (Series VI on the f/1.9 lens). C44R accessory lenses hold Series VI filters without adapters.

FLASH: Mounts on top of the camera; no wires to connect; folding reflector accepts bayonet-base or M-base flashbulbs; battery-capacitor type with test light and flash calculator; accepts one 22.5V battery—Ray-O-Vac 221, Eveready 505, Burgess Y15, Bright Star 22P, or equiv. Push-button flashbulb ejection.

argus C44R

OWNER'S IDENTIFICATION CARD

--	--	--	--	--

CAMERA
SERIAL
NUMBER

OWNER'S
NAME

STREET
ADDRESS

CITY &
STATE

PHONE
NUMBER

Carefully cut this card from the page and keep it in your wallet or other safe place for future reference.

For service, replacement parts, or further information on the operation of your camera, see your local Argus dealer or write to:

CUSTOMER SERVICE DEPARTMENT
ARGUS CAMERAS, INC., ANN ARBOR, MICH.
Subsidiary of Sylvania Electric Products Inc.

In Canada, write to:

ARGUS CAMERAS OF CANADA, LTD.
REXDALE, ONTARIO

When writing about your camera, always mention the camera model number and the serial number (found on the camera bottom).



care and cleaning

Your Argus C44R was designed and manufactured by skilled craftsmen.

Protect your camera from dust, moisture, and heat. Do *not* store the camera in the glove compartment of your car or any other place where temperature tends to rise or where there is vibration.

The lens on your camera is ground, polished, and coated with extreme precision. If it needs cleaning, blow off the dust first, then use a soft lens brush, or wipe it gently with lens cleaning tissue.

The working parts of your camera include fine threads, tiny screws, and precision adjustments. Never force any parts to work if they resist, nor should you oil any parts of the camera.

ARGUS C44R ACCESSORY LENSES

Instantly interchangeable Argus Cintagon lenses provide the right focal length for every picture. A quick twist and the lenses are removed or installed. The f/3.5 100mm Telephoto and f/4.5 35mm Wide Angle Lenses are focused automatically by the rangefinder.

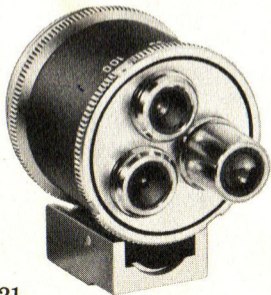

ARGUS TURRET VIEWFINDER

This fine viewfinder shows you the views taken in by either of the C44R accessory lenses and the normal lens. An efficient parallax adjustment tilts the viewfinder so you see just what the lens sees, at any distance. Flash contacts in the base allow you to use your flash unit on the Argus Flash Extension Bracket.

ARGUS COUPLED EXPOSURE METER

The meter fastens firmly to the camera and couples directly to the camera's shutter. For perfect exposures, just aim the camera and meter at the subject and set the camera lens to the opening shown.

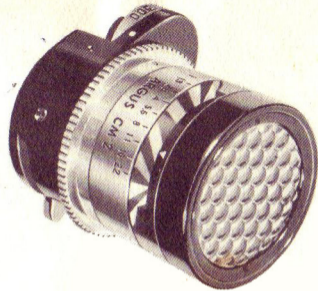
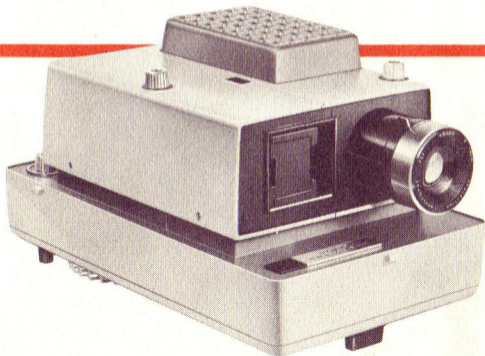

ARGUS PRESIDENT PROJECTOR

The ultimate in fine color-slide projectors. Completely electrical operation lets your slide show run itself. Built-in timer, brightness control, power elevation, and a host of other advanced features.

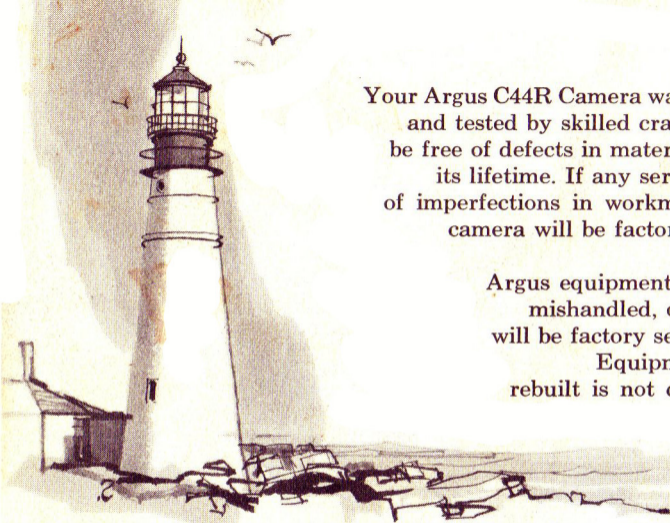

Your Argus C44R Camera was manufactured, inspected, and tested by skilled craftsmen. It is guaranteed to be free of defects in material or workmanship during its lifetime. If any servicing is necessary because of imperfections in workmanship or materials, your camera will be factory serviced without charge.

Argus equipment which has been damaged, mishandled, or worn from extensive use will be factory serviced at established rates.

Equipment purchased as used or rebuilt is not covered by this guarantee.

ARGUS CAMERAS, INC., ANN ARBOR, MICHIGAN

A Subsidiary of Sylvania Electric Products Inc.

ARGUS CAMERAS OF CANADA, LTD., REXDALE, ONTARIO

PART NO. 21485-601

LITHO IN U. S. A.