

WILSONWERKS ARCHIVES

This camera manual is for reference and historical purposes, all rights reserved.

This cover page is copyrighted material. This document may not be sold or distributed without the express consent of the publisher.

©2008-2012 wilsonwerks Llc

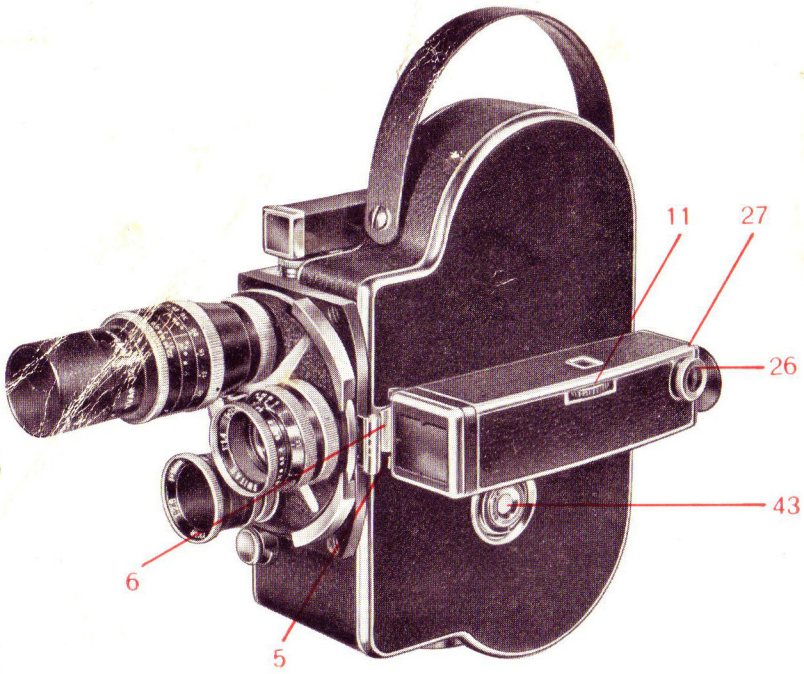

Fig. 9

Instructions for Use

of PAILLARD-BOLEX Model H Cameras

	Page
Chapter I : Loading the camera	3
Previous to loading — Film check in H 8 cameras — Automatic loading.	
Chapter II : Film Transport	6
Footage counter — Frame counter — Speeds — Starting the mechanism — Single exposure device — Handcranking.	
Unloading the camera	10
At the end of a film — Before the complete reel has passed through.	
Chapter III : Lenses	11
Interchangeability — Lens turret with slot for gelatine filters — Octameter Viewfinder — Using the viewfinder with lenses of various focal lengths — Parallax correction.	
Chapter IV : How to film	14
General rules — Critical visual focusser — Adjustment of diaphragm.	
Chapter V : How to film — Various possibilities	18
Color films — Indoor subjects with or without artificial lighting — Titling — Illusion of movement — Portrait attachments, color filters, vignettes — Ordinary fades, superimpositions, lap dissolves — Other tricks — Camera identification number.	
Chapter VI : Upkeep	21
Oiling.	
Eye-Level Focus	22
Trifocal Viewfinder	24

Model Designation :

Each model H camera has engraved on the front of the view-finder the size of film for which the camera is intended : H 16 for 16 mm films and H 8 for double run 8 mm films.

Equipment :

Each model H camera is supplied with at least one lens and the following accessories :

- 1 rewinding handle **25**
- 1 handcrank
- 1 flat-headed screw
- 2 stoppers for turret (screw into unused lens holes).
- 1 eye-piece, supplied only in default of eye-level focus

H 16 cameras :

- 2 empty take-up spools, one of 50 ft. and the other of 100 ft. capacity.

H 8 cameras :

- 3 empty take-up spools (for 25 ft., 50 ft. and 100 ft.). The spools for 8 mm double run differ from those for 16 mm in that they have different holes for the spool spindles and are marked I and II in white figures on the flange.

Preliminary directions :

1. Read carefully all instructions relating to the use of the apparatus.
2. Before loading with a spool, get acquainted with the various controls and practise with the automatic loading device.
3. Never work the apparatus at a speed higher than 32 frames per second unless the camera is loaded, as there is a risk of injury to the mechanism.
4. Do not rewind the spring motor unless lever **12** is on " Motor ".

CHAPTER I

Loading the Camera

Previous to loading :

- a. The starting button **22** must be placed on " Stop " (Fig. 2).
- b. Lever **12** must be clearly set on " Motor ".
- c. The speed control **19** must be placed on 16 frames per second, i.e. the figure 16 must be opposite the red point.
- d. Rewind the motor to the full, by means of rewinding handle **25**.
- e. Remove the lid by means of button **43** (Fig. 9), giving a half-turn anti-clockwise (0 ←).
- f. Push down lever **37** into the position shown in Fig. 8, so as to close the loop guides.
- g. Make sure that the film guides **34** and **36** are pressed against the sprockets **32** and **38** and that pad **33** is pressed against gate **35**.
- h. Place the spool of film on top spindle **29** so that the film will unwind in the direction of the arrow shown in Fig. 5 (clockwise).
- i. The film must not be cut to a point (Fig. 4) nor must it be crinkled. Hold the film between the thumb and the index finger of the left hand and pass it through knife **41** (see Fig. 5 and 7). With the index finger of the right hand press hard on blade **42**, which will cut the end of the film to the right shape for passage through the automatic loading device. Throw away the cut end of the film to prevent its passing through to the mechanism.

Film check in H 8 cameras :

H 8 cameras are provided with a film check which presses against the coils of film on the feed and take-up spools, thus preventing them from unrolling during loading or at the end of a shooting (Fig. 10).

Before setting the spools in position in the camera, open fully the two levers **45** and **46**, placing them in position c.

Hold the full spool in such a way that the coils do not unroll and place it on its spindle **29**, the notch at the centre of the spool facing the red mark on the spindle. Once the spool is in place, regulate the position of lever **45** according to the capacity of the spool by slightly lifting knob **47**.

- 25 ft. spool = position a ;
- 50 ft. spool = position b ;
- 100 ft. spool = position c.

When loading is completed (see page 5) and the take-up spool in place, regulate film check lever **46** in the same way.

When unloading the camera, hold the take-up spool in such a way that the coils do not unroll, then open fully lever **46** (position c) before removing the spool.

(See chapter II, last paragraph, page 10.)

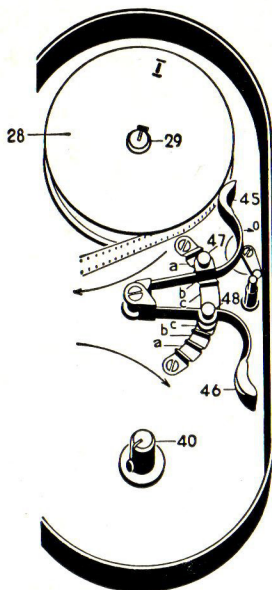

Fig. 10

Automatic loading :

- a. Introduce the film into the mechanism through opening **30** (Fig. 8).
- b. Press button **21** to set the motor in motion.
- c. As soon as the film has passed through the lower sprocket **38**, stop the mechanism by releasing pressure on button **21**.
- d. Push up lever **37** so as to bring it back to the horizontal position (see Fig. 7). This will open the loop guides **31** and **39**. Set the motor going once again until the end of the film emerging from sprocket **38** is of a length of about 8 to 10 inches.
- e. Insert the end of the film into the core slit of the take-up spool, wind the film around the core and place the film on lower spindle **40**.
- f. Set the mechanism going for a second or two to make sure that :
 - the loop guides are open,
 - the loops keep their shape,
 - the film guides and pad are closed,
 - the spools are placed well home on their spindles,
 - the film winds onto the lower take-up spool.
- g. Replace the lid of the camera and lock this by turning button **43** in a clockwise direction (—→F). If any difficulty is experienced in replacing the lid, do not force it, but make sure that all parts of the film transport mechanism are in position, as in Fig. 7.
- h. In case of incorrect loading, remove the film, wind it back on to the top spool (see page 9), and reload more carefully. If need be, see page 10.
- i. To check up at any time whether any film is left in the gate, proceed as follows :

Move lever **17** to position T (**18**), switch round the turret so as to see the window of the gate and set lever **22** on P (**23**), thus moving the shutter out of the line of vision. It will then be seen whether the leader, film or trailer is still in the gate. If any unexposed film (yellow) is left in the gate, then only one picture will be fogged.

CHAPTER II

Film Transport

Footage counter :

The counter 15 (in metres or feet) automatically returns to zero as soon as the lid of the camera is removed. It only functions once the lid is in position. The space on the scale between A and O corresponds to the passage of a length of approximately 4 ft. of leader. It is provided for the passage of the film or leader which is fogged during the loading. Once the lid has been closed, set the mechanism in motion until the figure 0 appears opposite the line on the counter. If the film used is without leader or if the camera has been loaded in a dark room so as to avoid any possibility of fogging, " shooting " may be started immediately.

The counter, which is worked by the film transport mechanism, adds when the film is being taken up by the lower spool and subtracts when the film is being returned to the top spool. The counter registers the amount of film exposed to within 4 inches. The passage through the gate of each 25 centimetres (approx. 10 inches) of films is recorded by a slight clicking sound. It is therefore possible to estimate the length of a scene without removing one's eye from the viewfinder. A normal scene (portrait, etc.) generally measures from one to two metres of film ($3\frac{1}{2}$ to 7 ft.), corresponding to 4-8 clicks of the counter.

To soften the sound of the audible footage indicator, or to put it out of action, set on 0 (\rightarrow 0) the small lever 49 located inside the camera (Fig. 11).

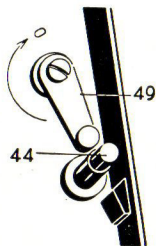

Fig. 11

Frame counter:

Upper dial. — The upper dial **adds** the frames in forward motion and **subtracts** them in reverse motion :

from 0 to 50 frames, for the H 16 camera,

from 0 to 100 frames, for the H 8 camera.

Lower dial. — The lower dial **totalizes** the frames in forward motion and **subtracts** them in reverse motion :

in 50's up to 1000 frames, for the H 16 camera,
in 50's up to 2000 frames, for the H 8 camera.

Beyond these figures, the cycle starts again and the totals indicated by both dials must be added to the 1000 (or 2000) frames already totalized. It will be easy to check at any moment if the totals given by the frame counter dials are a first or a second cycle by simply checking the footage counter ; bear in mind that :

1000 frames of 16 mm film correspond to 7,62 m (25 ft.) of film,
2000 frames of 8 mm film correspond to 7,62 m (25 ft.) of film,
in other words :

1 metre of 16 mm film contains 131,23 frames,

1 metre of 8 mm film contains 262,46 frames.

(The figures given for 8 mm films refer only to **one** row of frames on double 8 mm film.)

Setting frame counter back to zero :

First set the "frame by frame" dial back to zero by turning milled knob on shaft **14** for handcranking. **Then** set the "totalizator" dial to zero by turning the milled knob which is just underneath both dials.

Marking if a partly exposed film has to be removed :

If a partly exposed film has to be removed from the camera and used again after shooting with other films, proceed as follows :

When loading the first film, mark the leader with a colored pencil or with ink (through the aperture which is accessible when the turret head is turned),

then set the frame counter to zero.

When removing the film note the figures of both the frame counter and the footage counter.

If all this is done with the utmost care, it will be easy to reload the film which must start at the exact point where the exposure has been interrupted. (See paragraph : **Unloading the camera**, page 10.)

Speeds :

Button **19** enables the speed to be altered, even while the mechanism is in action, from 8 to 64 pictures per second. **Never work** the mechanism at a higher speed than 32 pictures per second unless the camera is loaded, as this is injurious to the mechanism.

The **normal speed** of motion pictures is **16 frames per second**, that is to say, the **normal speed of projection of silent films**. A film "shot" at a speed lower than 16 frames per second will give on the screen an impression of accelerated movement. A film "shot" at a speed higher than 16 frames per second will give a slow-motion effect. (See paragraph : **Diaphragm opening and speed**, page 16.)

Starting the mechanism :

The mechanism is set in motion by pressing sharply on button **21** : as soon as pressure on this button is released, the mechanism will stop. This is the normal starting button. To film without being compelled to remain near the apparatus—for instance, to film oneself—move the lateral button **22** on to M (**24**). To stop the mechanism, move the same button on to "Stop".

Single Exposure Device :

To make a single exposure, move button **22** to P.

Time exposures are made by pushing down lever **17** to position T and then setting button **22** on P. The shutter will remain open as long as button **22** is kept on P.

To obtain **instantaneous** exposures, move lever **17** to position **I** and then set button **22** on **P**.

The antinuous release is an accessory available on request. It allows the mechanism to be set in motion without jerking or unsteadiness, whether moving pictures or single exposures are being made.

Handcranking (forwards and backwards) :

To disengage the spring of the motor, whether fully wound or not, bring down lever **12** to **0 (13)** (down to the end of the arrow). In case of resistance being felt before lever **12** can be brought right down, push button **21**. This will ease the operation. The transport mechanism of the film is thus made independent of the clockwork motor and may be worked by other means. To handcrank, introduce the handle provided into socket **14** and set button **22** on **M**. To wind the film backwards, turn the handle in the direction of the arrow. To handcrank forwards, turn the handle the other way. The speed regulator also acts as a brake when the mechanism is worked by hand, so that one should try not to handcrank faster than the speed for which button **19** has been set.

When being wound backwards, the film is automatically taken up by delivery spool **28**. It is therefore possible to wind back any length of film. When the film is wound back, the counters subtract. Axis **14** may also be operated by some other means than handcranking—for instance, by a special electric motor.

Never rewind the motor by means of the handle whilst the motor is disengaged.

To re-engage the spring motor, move button **22** on to " Stop ", detach the cranking handle and bring lever **12** on to " Motor ".

Safety locking device :

To prevent the mechanism from starting and ruining the film when the camera is loaded, either by accident or on account of careless handling, move lever **12** to position " **0** " (down to the end of the arrow).

Unloading the Camera

At the end of a film :

As soon as a reel has been exposed, which can be ascertained by means of the counter, allow the mechanism to work for a little while to make quite sure that the trailer has passed through. This can be checked at all times as directed on page 5, last paragraph. Get ready the metal container in which the reel of film was supplied. Open the camera, preferably in a shady corner, and replace the reel of film **immediately** in the metal container, which in its turn should be put into the cardboard box ready to be sent for processing.

Before the complete reel has passed through :

Push down lever **17** to T. Remove the lid, either in a shady corner or, if possible, in total darkness. The loop guides **31** and **39** are already open. Open film guide **34** by slightly lifting the knob which holds it in position and remove the film from sprocket **32**. Close film guide **34**. Open film guide **36** by slightly lifting the knob as with guide **34**, and open pad **33** in the same way. Now move button **22** on to P so that the claw is withdrawn from the gate, and while holding it in this position remove the film from the latter and from sprocket **38**.

Close film guide **36** and pad **33**. Close the loop guides for the next automatic loading.

(See paragraph : **Marking if a partly exposed film has to be removed**, page 7.)

Special note on double run 8 mm films (model H 8 camera) :

When double run 8 mm film has been passed through the camera once, it has only been exposed on one side. To expose the other side, turn round the spools and reload as instructed in Chapter I.

The white figures I and II on Bolex spools supplied with the apparatus will serve as a reminder as to whether the film has been exposed on one or both sides.

CHAPTER III

Lenses

Interchangeability of lenses :

The Bolex model H camera is made to take interchangeable lenses, the mounts of which are provided with an international standard thread. Model H 16 takes standard 1 inch thread (25.4 mm, setting 17.52 mm), while model H 8 takes the small standard 5/8-inch (15.8 mm, setting 12.29 mm). Thus it is always possible to complete the optical equipment by the purchase of new lenses of varying focus and power and of any make.

Each lens supplied with the camera must be accompanied by a **certificate** from Paillard S. A., bearing the numbers of the lens and of the apparatus and guaranteeing accurate focussing. When lenses are purchased after the camera has been bought, it is recommended that such lenses be sent with the camera to the Paillard Works or to their accredited representatives, and a new certificate in respect of the proper fitting of such lenses should be insisted upon.

The lenses must be screwed securely into the lens openings, but must not be forced.

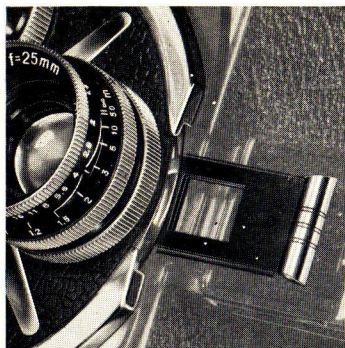

Lens turret with filter slot for gelatine filters

Paillard Bolex H 16 motion picture cameras are fitted in a new version with a turret provided with a slot to take gelatine filters. The filters are slipped in position behind the lens through a slot in the side of the turret supporting plate. Thanks to this arrangement, only a single set of filters is necessary, no matter what lens is in use. A filter holder is provided for each gelatine filter.

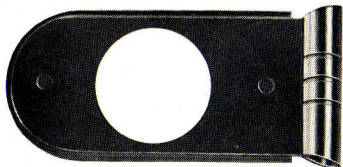

When shots are being made without a filter, the slide mask (with round hole) must be left inserted in the camera to prevent light from entering the slot and fogging the film.

Bolex H 16 cameras with filter slot are supplied complete with the following accessories :

5 filter holders, in case ;
1 slide mask (with round hole),
ready inserted in filter slot ;
5 sachets each containing a
2" x 2" gelatine filter, as
follows :

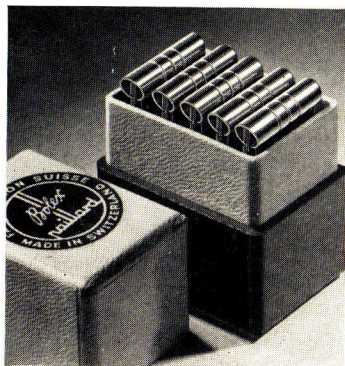

1	Kodak Wratten	1	A	Skylight filter
1	»	»	85	Daylight filter
1	»	»	8	K2 yellow filter
1	»	»	15	G yellow-orange filter
1	»	»	25	A red filter

Instructions

for using the gelatine filters

Warning ! Handle the sheets of gelatine or the prepared filters carefully by picking them up at the edges only, as fingerprints are indelible.

To cut out a gelatine filter, place the filter between two dry, smooth pieces of paper and cut to shape, using well-sharpened scissors. The filters are prepared as follows :

1. Remove the filter holder fastener, separate the two plates and withdraw the spring clamp.
2. Cut out a rectangle, size 7" x 6", in the gelatine sheet.
3. Insert the filter just cut out in the rectangular recess in the plate. Lay the spring clamp on the edge of the filter and fit on the second plate. Then fix the fastener in position.
4. Keep the mounted filters in their case, away from dust,

Identification marks : The 3 grooves on the fastening clamp can be colored to facilitate identification of the filter required. Any suitable color code can be used.

Filters for black-and-white films

Wratten filters 8K2, 15G and 25A are intended to heighten the contrast between different colors, translated on the film as various shades of grey. When these filters are used, the diaphragm aperture must be increased as compared with the normal reading, by the following amounts :

1 stop	for Wratten filter	8K2	yellow
1.5 stops	»	»	15G yellow-orange
2.5 stops	»	»	25A red

The effect produced by a filter varies according to the make and sensitivity of the film and to the prevailing lighting conditions. The correction factors just quoted are therefore not absolute, but merely serve as an approximate guide.

Filters for color films

The « **Skylight** » filter is used to cut down exaggerated blue overtones and to improve rendering of colors in shots made in the shade or under overcast skies, in views of far-off landscapes, and snow or high-altitude scenes. No correction of the diaphragm is needed when this filter is in use.

The « **Daylight** » filter is a conversion filter, and is used for shooting films in daylight with Kodachrome Type A film intended for artificial light. In setting the diaphragm, account must be taken of the fact that color film designed for artificial light, when used with the « **Daylight** » filter, has the **same sensitivity** as daylight-type color film used without filter.

Correction of focusing :

The fact of placing the filters behind the lens slightly alters the focusing setting for a given distance. Diagrams opposite show the positions to which the focusing rings of Kern-Paillard 16 mm, 25 mm and 26 mm lenses must be set to obtain perfectly sharp pictures, **no matter which filter is used.**

E.g. For a filming distance of 10 ft., the Yvar 16 mm's focusing ring should be set to 7 ft. On the other hand, the available depth of field will still correspond to that for a shooting distance of 10 ft., i.e. 4,8 ft. to infinity, if the diaphragm is set to 1:2.8.

Lenses with focal length of
 $f = 25$ or 26 mm $f = 16$ mm

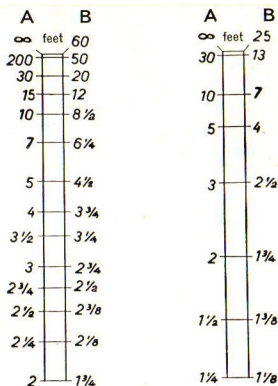

A = Filming distance measured from film plane. B = Distance to be set to on the lens scale when using a slide-filter.

This correction is only necessary when the diaphragm is opened fairly wide ; furthermore, it should be noted that in the case of the telephoto lenses and of the Pan Cinor 16 mm lens, a correction is, practically speaking, not necessary.

Stereo motion pictures

When shooting three-dimensional motion pictures with the Kern-Paillard Stereo equipment, the slide mask must be inserted in the filter slot. In this case, however, the gelatine filters cannot be used, as the stereo lens penetrates too deeply into the turret supporting plate.

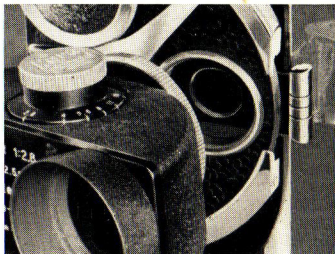

Turret handle

The handle is permanently mounted on the new-type turret and can be folded back completely. It makes the turret considerably easier to handle and eliminates all risks of accidentally upsetting the setting of the lenses, since the latter need no longer be used as levers as an aid in turning the turret.

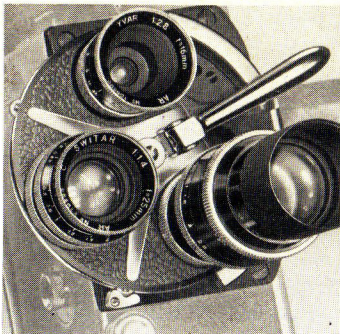

Position of lenses for groundglass focusing with the Eye-Level Focus : The new lens turret 2 is provided with 3 click-stops 3, ensuring positive selection of the correct position for groundglass focusing, whatever the lens in use.

Octameter Viewfinder

(for Trifocal Viewfinder, see page 24)

The new Paillard-Bolex OCTAMETER Viewfinder is so constructed that its field of view can be continuously varied to correspond with the field obtained with lenses of 8 different focal lengths. It is available in two models :

VICON for H 16 camera, focal lengths 16-25-35-50-
63-75-100-150 mm.

The length of 63 mm. is not engraved on the disc. This position is marked by a click-stop between the focal lengths of 50-75 mm.

VIHUI for H 8 camera, focal lengths 6,5-9-12,5-25-36-50-
63-75 mm.

The lengths of 9 and 63 mm. are not engraved on the disc. These positions are marked by click-stops placed between the lengths 6,5-12,5 and 50-75 respectively.

The viewfinder can only be used on the lid of the camera, as in this position, vertical parallax error is entirely eliminated. Guide marks on the sighting aperture make vertical and horizontal centering of the subject an easy matter. Each viewfinder is individually adjusted and tested to suit the particular camera for which it is intended, and the camera's serial number is also engraved on the viewfinder, in front of the mount.

Moviemakers with defective eyesight who experience difficulty in using the viewfinder owing to poor accommodation can remedy this by having a corrective lens of the appropriate power fitted into the viewfinder eyepiece. In this case it will be advisable to get in touch with the general Bolex agent in your territory through your nearest Bolex distributor, stating the lens power required.

Instructions for use :

To fit the new Octameter Viewfinder on the camera lid, first insert the pivot bar **5** well home in clamp **6** on the camera lid (Fig. 9). For this operation, the catch **7** should be in the position shown in fig. 12. Now swing the viewfinder down onto the lid until the pin **8** has fully penetrated hole **9** in bracket **10**.

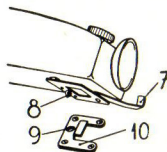

Fig. 12

Then turn the catch as far as it will go in the direction shown by the arrow, so that it takes up the position shown in fig. 13. The viewfinder is now firmly fixed onto the camera lid.

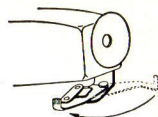

Fig. 13

To **remove** the viewfinder, open catch 7 completely ; lift up back of finder until pin 8 is clear of hole 9 ; then twist the viewfinder down about a quarter-turn towards the base of the camera, thus freeing the pivot bar 5 from clamp 6.

The field of the viewfinder is adjusted by turning the milled disk 11. The focal lengths corresponding to the field can be ascertained either through the aperture on the top of the viewfinder, or while sighting is being carried out, by reading off the luminous numbers which appear under the front aperture (see fig. 14). In either case, the field of the viewfinder will correspond to the field obtained with a lens of a focal length equivalent to the number shown.



Fig. 14

Correction of parallax effect :

As already stated, vertical parallax effect is nil when the viewfinder is set up on the camera lid, and the slight residual horizontal error can be compensated by shifting the after part of the viewfinder. This is done by turning knob 26, which carries a scale graduated according to the distance between the subject and the film plane. When the number corresponding to the taking distance is set opposite the fixed index 27, horizontal parallax is eliminated and an accurately centered image of the subject will be obtained. As a precautionary measure the scale should be reset to 'infinity' (∞) at the end of each take.

CHAPTER IV

How to Film — General Rules

Speed :

Regulate the speed, remembering that the normal speed for projection is 16 frames per second.

Viewfinder-Parallax :

Correct the parallax according to the distance between the lens and the subject so as to obtain dead accurate centering.

Varying focal length of lenses :

Make sure that the viewfinder is regulated for use with the taking lens on the turret.

Focussing :

All lenses supplied with the model H camera are fitted with a focussing ring. This permits them to be regulated to the distance between the subject and the lens, thus making for pin-point definition. The nearer the subject to the lens, the greater must be the care taken to ensure accurate focussing. More care in focussing is also demanded by large aperture lenses, particularly when it is necessary to use a large stop.

In case of doubt in the estimation of distance, it is best to err on the long side. When the subject is moving towards the camera it is advisable as a general rule to focus for the nearest spot to which it will approach. On most lenses, the scale engraved corresponds to a distance measured from the plane of the film to the subject.

See our depth of focus table.

It should be remembered that the plane of the film in Model H 16 is 17.52 mm, and in Model H 8 12.29 mm, from the base of the lens when the latter is screwed home in position. This plane is indicated by a line (1) engraved on the edge of the case, at a height corresponding to the axis of the turret. Make sure that the focussed lens is in the taking position on the turret, i.e. opposite the opening in the gate.

Instructions for the Use of the Critical Visual Focuser :

A prism covering a large part of the subject is fitted inside the camera opposite the upper lens opening of the turret. The prism is protected from outside dust by a flat-headed screw which can be removed when it is desired to use the prismatic focussing device. To facilitate the observation of the image, an eyepiece can be fixed on the viewfinder. Center the subject through the viewfinder. Rotate the turret so that the lens it is wished to focus is in front of the prism. Open out fully the iris diaphragm of the lens. Focus by means of the focussing mount on the lens until the subject, seen through the magnifying glass, is quite sharp. Rotate the turret so that the lens thus focussed is brought into the taking position, being careful not to disturb the setting. Set the iris diaphragm to correspond with the required exposure and once again check the centering through the viewfinder.

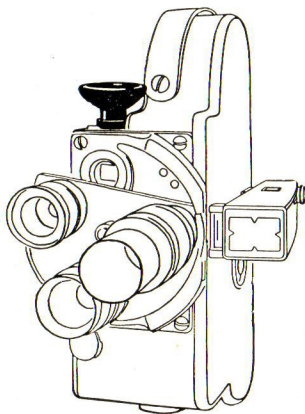

Fig. 15

Diaphragms :

Regulate the opening of the diaphragm of the lens according to :

1. The amount of light on the subject.
2. The speed at which the speed regulator has been set.
3. The H and D speed of the film.

The special Paillard-Bolex table shows the opening of the diaphragm for most usual subjects. Consult this table often until you have memorised the information given. The closing of the diaphragm to the extent of one of the graduations marked on the scale diminishes by half the amount of light allowed to pass through the lens. The opening of the diaphragm by one graduation doubles the amount of light, opening by two graduations quadruples it, and so on.

Important ! — Opening of diaphragm is obtained by turning the ring towards a **smaller** figure (2.8 is a greater opening than 4). It is closed down by turning it to a **higher** figure.

Diaphragm opening and speed :

It should be borne in mind that altering the speed alters the time of exposure. Thus, when filming at 8 frames per second, the time of exposure is doubled. The normal time of exposure is $1/40$ * second at 16 frames per second, which is the normal speed for shooting. When the film is run at 64 frames per second, the exposure is reduced to a quarter of the normal, i.e. to $1/160$ * second. Set the diaphragm of the lens accordingly.

* Exposure times with cine-cameras { H 16 from Nr. 100401
 { H 8 from Nr. 97801

by **one** stop on the scale. If the rate is quadrupled, open by **two** stops. On the other hand, if the film runs at 8 frames per second, close the diaphragm by **one** stop.

Exposure meter :

The use of a **good quality** exposure meter is recommended as a help towards the avoidance of irregularities in exposure.

Steadiness :

Hold the camera **very steady**. Whenever possible use a stand or some other support. A stand is necessary when filming with a lens of a higher focal length than 50 mm (2").

The base **4** of the camera is provided with a universal screw fitting for a stand. For use with Kodak thread a special bush can be supplied.

Panoraming :

Panoram very slowly. Allow the subject to move within the field of the lens, otherwise follow the subject very slowly.

Rewinding :

Rewind the spring of the motor after every scene.

Varying light intensity on subjects :

As far as possible avoid filming too many dark and light subjects one after the other.

Breakdowns :

In case of jamming, do not force any part of the mechanism. Endeavour to rectify the trouble in a dark room or a shady corner so as to avoid fogging too much film.

CHAPTER V

How to Film — Various Possibilities

Color films :

All makes of color film can be used on model H cameras. The steady running speed of the apparatus from the first frame of each scene ensures excellent results even with color emulsions which are particularly sensitive to the slightest difference in time of exposure.

Follow the directions contained in the cartons issued by the film manufacturers.

Indoor subjects with or without artificial lighting :

If a large aperture and high-speed film are used, indoor films may be taken with the Model H camera ; very good results are also obtained by means of artificial lighting. To ascertain the diaphragm at which to set the lens, consult an exposure table or use an exposure meter.

Titling :

The model H camera lends itself admirably to the taking of titles as it incorporates all necessary features, i.e. focussing of the lens, dead accurate centering of the viewfinder down to 20", taking speed of 8 pictures per second in case of poor lighting, handcranking or working of the mechanism by means of an electric motor, reverse mechanism.

Illusion of Movement :

Thanks to the single exposure device, it is possible to create an illusion of movement in subjects which the eye is accustomed to see at a standstill. In this way the growth of a plant, animated drawings or titles, etc. may be brought on to the screen, and the effect of movement be obtained in any subject by changing its position after each single exposure.

Needless to say, the illumination used from one exposure to another must remain the same or else the diaphragm of the lens must be regulated accordingly. Above all, the camera must be held steady.

Always keep our little celluloid exposure table handy in case of need.

Portrait attachments, color filters, vignettes :

To film subjects at smaller distances from the lens than any provided on the scale, a portrait attachment should be fitted in front of the lens. These attachments are obtainable for most lenses. Special attachments can also be obtained for trick work in which distorted pictures and other comic effects are required.

Color filters are further accessories which are obtainable for most lenses, their effect being the filtering of light rays in order to bring certain parts of the subject (clouds, half tones, contrasts, distant object, etc.) into relief.

Consult our table of instructions for the use of color filters.

Ordinary fades, super-impositions, lap dissolves :

A fade consists in the introduction or closing of a scene by means of a progressive appearance or disappearance of the subject, which is often more pleasing to witness on the screen than an abrupt change of scene. In a "fade-in" the screen at first appears dark, and the picture then slowly becomes clearer until it is normal. In the "fade-out" the picture disappears gradually on the screen. (These effects are obtained by under-exposure, the amount of light allowed to pass through the lens being slowly changed.)

These fades can be obtained by using a "totally closing iris diaphragm", sold by most dealers. This iris can be attached to the front of the lens to form a supplementary diaphragm ; it is manipulated by means of a loose lever and permits of the progressive closing down of the diaphragm until complete darkness is obtained.

The unlimited reverse action of the model H camera permits double exposures to be made over any footage of the film, for the purpose of obtaining super-impositions. When winding the film back on to the top spool for double exposures do not forget to cover the "taking" lens to prevent the light passing through whilst the film is being brought back. Make a note of the reading of the footage indicator so that you can wind back the exact number of feet required for double exposure.

Lap dissolves consist in "fading-out" and "fading-in" by means of super-impositions on the appearing or disappearing scenes. To make a lap dissolve, terminate the first scene as a "fade-out", making a careful note of the footage used for such a fade or timing it with a stop-watch. Then rewind precisely the same footage of film on to the top spool (taking care to cover the lens whilst doing so); film the next scene as a "fade-in" using precisely the same footage. One may also obtain fades by other means, such as the use of masks, opaque screens, etc. Fades obtained by means of the alteration of focus are also of interest, and it is possible to end a scene by throwing the subject out of focus or to start one out of focus and bring it up to normal.

Other tricks :

For other effects which can be obtained with the model H camera, read the information contained in books specially dealing with trick work.

Camera identification number

When corresponding with your supplier on the subject of this camera, please mention the number of the apparatus. This number appears on the casting near the top spool spindle (seen when lid is removed) and underneath the turret (seen when the turret is switched round).

CHAPTER VI

Upkeep

Keep the model H camera free from dust and damp. The exterior of the lenses must be cleaned from time to time with very fine tissue paper or a soft and dry cloth, and should be rubbed very gently so as to avoid scratching.

The inside of the apparatus must be kept very clean. Slight deposits of dust or emulsion may form in the gate or on the pressure pad during the passage of the film. These, and the aperture in particular, should be carefully cleaned by means of a clean cloth wound around the end of a pencil. If the emulsion deposit has hardened, damp the cloth slightly and wipe with a dry cloth.

Lubrication

Like a high-quality watch, the Bolex H camera rarely needs to be lubricated. When new, it contains a reserve of grease and oil sufficient to last for 2 or 3 years. When this length of time has elapsed, it is advisable to turn the camera in for fresh lubrication to the nearest Paillard Bolex agent.

Under no circumstances should any attempt be made to dismantle the camera mechanism, as the maker's guarantee is automatically forfeited if this is done.

Repairs and servicing :

Before going abroad, take care to obtain from your local photo dealer (who can get it from his general Bolex agents) the list of official Bolex representatives in the countries that you intend to visit.

If your camera should be in need of repairs, please get in touch with the general Bolex agents in the country where you are staying, as they are the only persons authorized to undertake repair work.

The makers' guarantee will automatically be revoked if any repairs are made to the camera by a third party without the express permission of the General Bolex Agents.

EYE-LEVEL FOCUS FOR PAILLARD-BOLEX H MOVIE CAMERAS

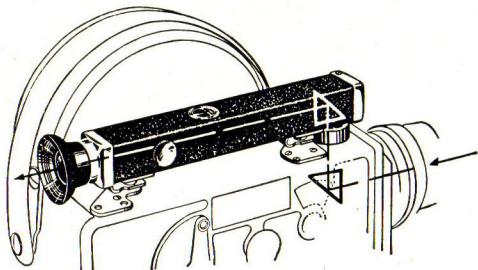

This accessory is intended for use with the ground-glass focussing prism (or Critical Visual Focuser) fitted to H 16 and H 8 cameras. Whereas when used alone this prism provides a horizontal image at the front of the camera, the Eye-Level Focus enables focussing with the ground-glass to be undertaken from the back of the camera, in the same plane as the viewfinder and with a vertical image. A brilliantly clear, distortion-free image is provided, at a magnification of $10\times$. When the 1" lens (H 16) or $\frac{1}{2}$ " lens (H 8) are in use, a ratio of 1 between the image and the subject as seen by the naked eye is obtained ; thus the image in the Eye-Level Focus can be superimposed on the retinic image seen by the other eye, with a consequent increase in the instrument's brilliance and convenience in use.

The Eye-Level Focus is particularly recommended for focussing high-speed lenses and telephoto lenses with the diaphragm wide open, for close-ups—which always require very accurate focussing—and for keeping an accurate check on depth of field. The Eye-Level Focus is made in two models : " REFSE " for H 16 and " REFTU " for H 8 cameras.

Instructions for Use

If your Eye-Level Focus has been purchased **separately**, carry out operations A to H.

If your camera was supplied with Eye-Level Focus already fitted, only operations E to H need be undertaken.

- A** Remove the trifocal viewfinder from the clamps at the top of the camera, and place it in the lateral position (on lid of camera).
- B** Unscrew the eyepiece lens of the critical visual focuser, which contains the magnifier, and which is situated in the upper front part of the camera, and replace it by the special magnifier lens supplied with the Eye-Level Focus.
- C** Unscrew the clamps which held the trifocal viewfinder in the upper position, and replace them by the special mountings supplied with the Eye-Level Focus.
- D** Slide the Eye-Level Focus well home onto the new mountings, so that the window in the front part of the instrument covers the special magnifier lens.
- E** Unscrew the flat-headed screw which protects the focussing prism on the camera, as is done for normal use of the critical visual focuser.
- F** **Without placing an objective in front of the prism**, adjust the Eye-Level Focus to suit individual eyesight by turning the small milled knob forwards or backwards until the grain of the ground-glass surface of the prism is seen in sharp focus when the camera is pointed towards the light. This adjustment remains valid whatever the lens in use. It needs only be altered if the operator's eyesight changes.
- G** The instrument is now ready for use. Place the taking lens in front of the prism, and bring the subject into sharp focus by rotating the focussing ring on the lens. Take care to open the diaphragm fully, so that the brightest possible image of the subject is obtained.
- H** Before filming do not forget to return the taking lens in front of the opening in the gate, and to set the diaphragm according to the amount of light available and the filming speed in frames per second.

If the image observed through the Eye-Level Focus appears off center or incomplete, proceed as follows :

- remove the metal cap A, which is retained by two small screws ;
- adjustments can now be effected in the vertical sense by slightly turning the small screw B, and in the horizontal sense by turning the two screws C, in the directions shown in the sketch at right.

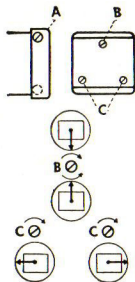

TRIFOCAL VIEWFINDER:

Some models of H cameras are supplied with a trifocal viewfinder (Fig. 6) permitting, like the Octameter Viewfinder, a strict correction of the parallax.

The camera number is also stamped on the viewfinder, near the eyepiece. This shows that the viewfinder has been specially adjusted for the camera on which it is fitted.

Placing the viewfinder in position :

To place the viewfinder in position, make the red guide markings **E** coincide, and introduce feet of viewfinder into the clamps of the lid. Push the viewfinder well home, and fasten it by turning milled ring **D** in the direction of the arrow shown in Fig. 6.

To remove viewfinder, repeat same operation in reverse.

Parallax corrector :

In this position there is no vertical parallax and the slight lateral parallax will be corrected by displacing eyepiece **F** of viewfinder by means of the knurled screw **G**. The scale given above eyepiece **F** corresponds to the distances between subject and lens. Always return the scale to ∞ after using the camera.

Using the viewfinder with lenses of various focal lengths :

When levers **H** and **J** on the viewfinder are placed horizontally, the viewfinder is ready for use with the standard focal length lens supplied with the camera. This focal length is engraved on the optical section **K** of the viewfinder. By raising or lowering levers **H** and **J** the finder is adjusted for use with one or other of the lenses of different focal length on the turret. The corresponding focal length is engraved on the lever.

The optical section **K** of the viewfinder is interchangeable. It is composed of the lenses and the levers, so that when a further set of lenses is bought a new set can also be bought for the viewfinder to correspond with them. Certain combinations of widely varying focal lengths, however, are not possible on the same finder.

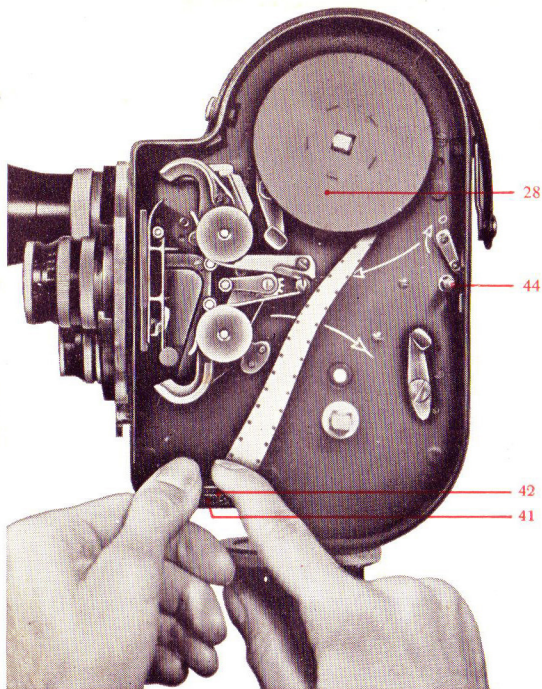

Fig. 5

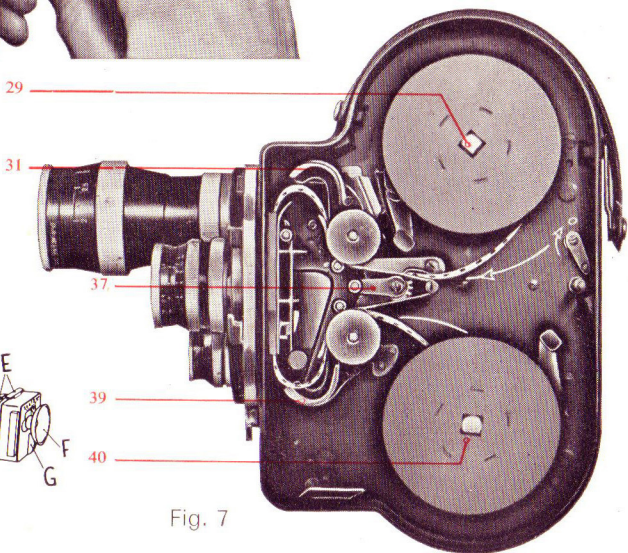

Fig. 7

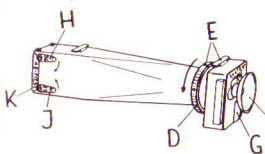

Fig. 6

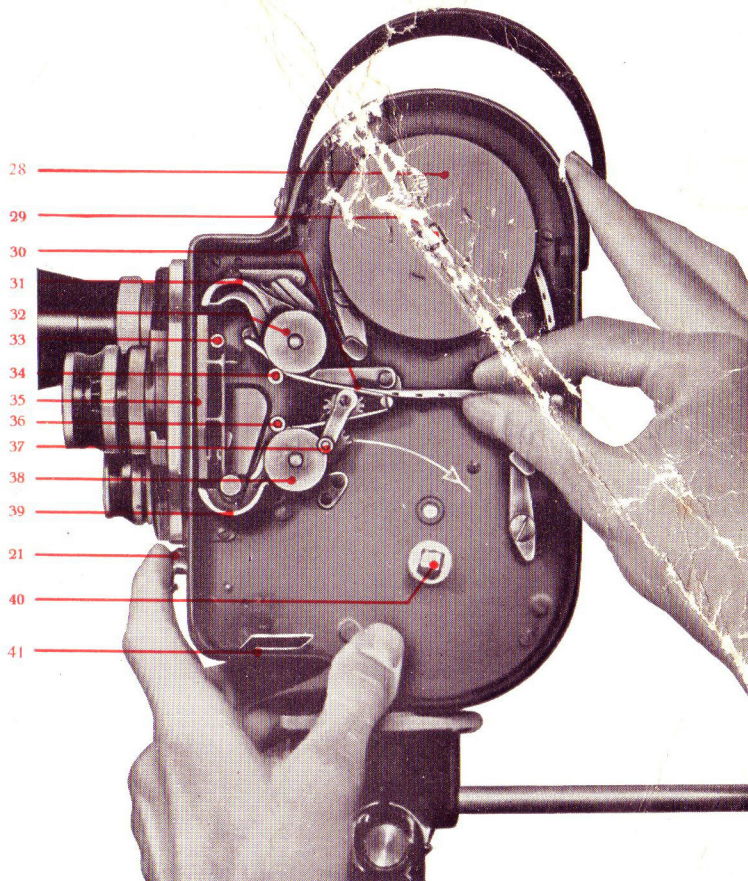
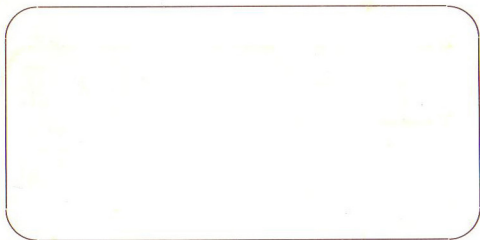
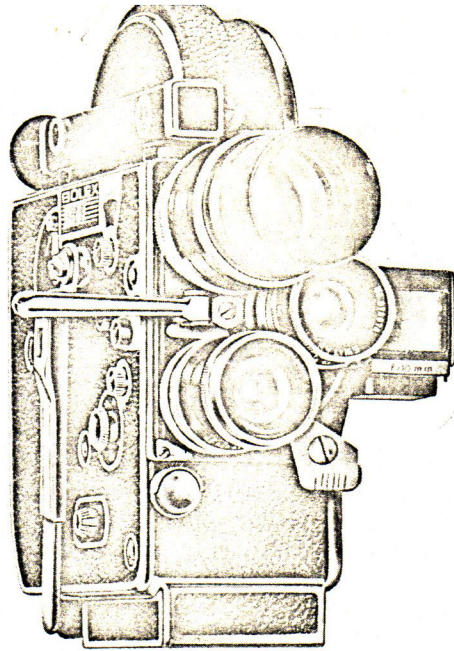

Fig. 8





FEB 3 1969



H16 STANDARD CAMERA

Your H16 S camera, basically similar to the H16 M model described in this Instruction Manual, incorporates the following improvements:

1. Three-lens turret

The turret holds three interchangeable lenses with the standard C mount (defined on page 19 of this manual).

2. Filter slot

The H16S cameras are provided with a built-in slot to take gelatine filters.

A filter holder (supplied with the camera) is inserted into a slot in the side of the turret holder, so that the filter will come between the lens and the taking aperture. Thus, the same filter can be used with any lens. When shots are made without a filter, the empty filter holder must be left in the slot to prevent light entering the camera and fogging the film.

The set of filters for the H16 Standard camera is made up of 4 filter mounts and a filter cutting frame in a case and 4 small envelopes each containing one 2" x 2" gelatine filter, i.e.:

Type	Open diaphragm: or	Divide ASA rating by:
Kodak Wratten 1 A	—	—
Kodak Wratten 85	2/3 stop	1.6
Kodak Wratten 8	1 stop	2
Kodak Wratten ND 06 .	2 stops	4

The effect of a filter varies according to the make of the film, its sensitivity and the lighting conditions, and so the above corrections must be considered as approximate only.

The 1 A Skylight filter (for colour films) is used for absorbing excessive ultra-violet light which tends to reproduce as a strong blue cast. Ultra-violet light is most prevalent in the shadows under a blue sky, at high altitudes (3,000ft. and over) such as in the mountains, and when filming from an aircraft. When using this filter it is not necessary to correct the diaphragm setting.

The 85 Daylight filter (for colour films) is a conversion filter for filming in daylight with a Kodachrome II Type A artificial light film. When setting the diaphragm, remember that artificial light colour film used with a daylight

filter has the same sensitivity as a daylight film used without a filter.

The Yellow 8 filter is used for increased contrast of black and white films.

The ND 06 is a neutral density filter which can be used for both black and white and colour films. It in no way affects colour reproduction. Since the ASA sensitivity is reduced 4 times, the diaphragm should be opened by two stops. This filter is used:

1. When lighting conditions and the film sensitivity require an aperture lower than the smallest stop on the lens.
2. When it is required to reduce the depth of field to obtain special effects (sharp foreground against blurred background).

Fitting the gelatine filters

Always use a pair of sharp scissors to cut the gelatine sheet, but without removing the protective paper covering. Care should be taken to handle them only at the edges, for fingerprints, once made, cannot be removed. Fit them as follows:

1. Remove the fastening clamp (a).
2. Separate the side plates (b) and (c).
3. Take out the spring clamp (d).
4. Cut a rectangle (e), size 18 x 15 mm., from the gelatine sheet.
5. Place the cut-out filter (e) in the rectangular recess (f) of the plate (c).
6. Lay the spring clamp (d) on the edge of the filter.
7. Fit on the second plate (b).
8. Put back the fastening clamp (a).

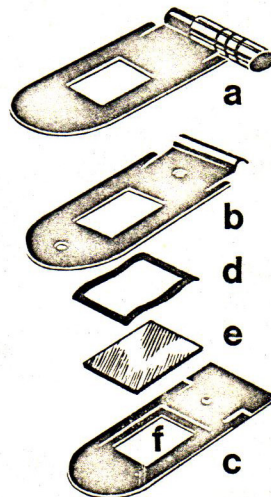

3. Ground glass focusing screen

The H16 Standard camera is equipped with a total reflection prism which is situated at the top of the turret holder. This prism incorporates a magnifying glass (10x) enabling the operator to observe from the back the picture which is forming on the front of the focusing screen.

This attachment adds to the convenience of the ground-glass focusing device by allowing the image formed on the groundglass to be observed from the back of the camera, vertically and in the same plane as the viewfinder. It provides a brilliantly clear, distortion-free image, enlarged 10 times.

Proceed as follows:

1. **Without placing a lens in front of the prism**, adjust the eye-level focus to suit your eyesight by turning the small milled knob in either direction until the grain of the groundglass surface appears clear and sharp when the camera is pointed towards the light. Once made, this adjustment will hold good whatever the lens in use, and need only be revised if your eyesight should undergo a change.
2. Place the selected lens in front of the prism and bring the subject into sharp focus by adjusting the focusing

ring, taking care that the lens diaphragm is fully opened, so that the brightest possible image is obtained.

3. Place the focused lens in front of the taking aperture and set the diaphragm according to the prevailing light and selected filming speed.

PAILLARD S.A., Sainte-Croix (Switzerland)

Suppl. ME 110/66 Anglais

Printed in Switzerland