

# WILSONWERKS ARCHIVES

This camera manual is for reference and historical purposes, all rights reserved.

This cover page is copyrighted material. This document may not be sold or distributed without the express consent of the publisher.

©2008 wilsonwerks Llc

**Canon**  
**AL-1**  
**QF** *Quick Focus*



INSTRUCTIONS  
English Edition





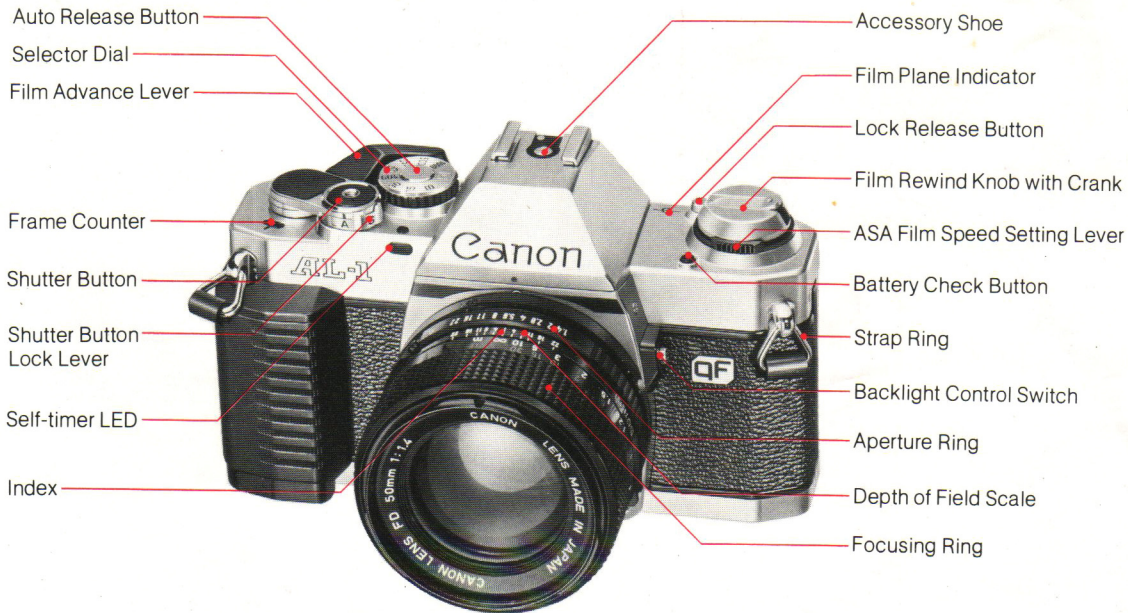



Thank you for purchasing the AL-1. Designed with the most advanced electronics technology available, this high performance SLR camera offers you creative freedom through its many innovative features. Your AL-1 can be used in aperture-priority automatic exposure (AE) mode. Manual override is also possible. The most innovative feature, however, is its quick-focus function in order to achieve fast, accurate focusing. We know that you are anxious to begin using this camera. Thus, these instructions have been written so you can begin taking pictures almost immediately. For initial picture-taking, "Basic Steps" will provide the necessary information. Once you have a good understanding of these operations, move on to "Making the Most of your AL-1". It contains information to assist you now and in the future, as your interest and skill in photography grow.



# Contents

## Basic Steps

1. Attaching the Lens	8
2. Loading the Batteries	10
3. Checking the Batteries	10
4. Learning the Basic Operation	11
5. Setting the ASA	12
6. Loading the Film	13
7. Learning to Hold the Camera Correctly	16
8. AE Photography	17
9. One Shot at a Time	18
10. Rewinding the Film	20
11. Self-timer	21
12. Dedicated Flash Photography with a Canon Speedlite	23
13. Carrying the Camera	24
• Pre-shooting Checklist	25
• Care	26

## Making the most of your AL-1

14. Battery	28
15. Viewfinder	30
16. Subjects Not Suited for the Quick-focus System of This Camera	32
17. AE Meter Coupling Range at Various Film Speeds	34
18. Exposure	36
19. Shooting with Light Behind Your Subject (and Other Unusual Lighting Situations)	42
20. Stopped-Down Metering AE	46
* Manual Diaphragm Control	
• Film Plane Indicator	49
21. Shooting with Infrared Film	50
• With Other Flash Units (60 f )	51
• Bulb	51
22. Caring for your Camera	52
23. Accessories	54
24. Specifications	58

Unfold the front and back flaps of this booklet for easy reference to camera parts while you read the instructions.







**AL-1**  
**QF** *Quick Focus*  
**Basic Steps**



# 1. Attaching the Lens

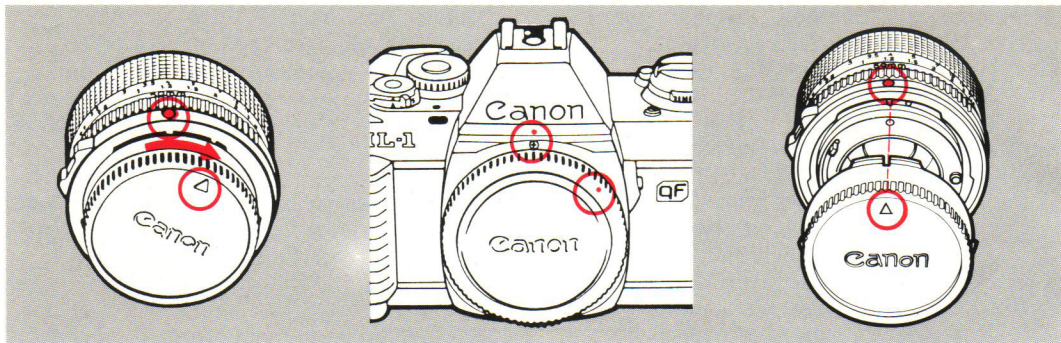

Turn the rear lens cap in the direction of the arrow until it stops and pull it off the lens.

Remove the body cap.

To reattach the rear lens cap, align it with the lens as illustrated. Then lightly push it in and turn it clockwise until it stops.

1. Make sure the lens release button has popped out. Otherwise, the lens will not work properly. **DO NOT** press the lens release button while mounting or it may not pop out.

2. When film is loaded, make sure it is completely advanced to the next frame before mounting the lens.

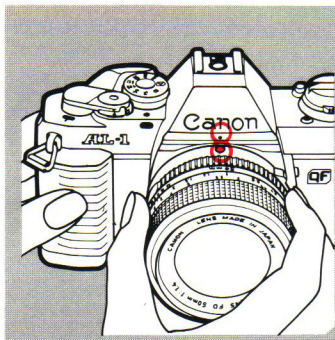

To mount the lens, first align the red positioning point on the lens with the red dot above the camera mount as illustrated.

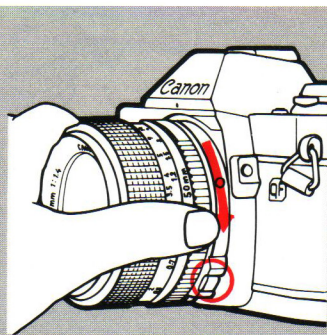

Then turn the lens in the direction of the arrow until it stops and the lens release button pops out with a click.

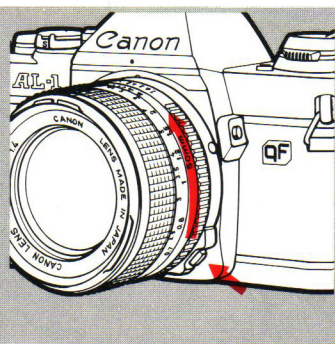

To dismount the lens, turn the lens in the direction of the arrow while pressing the lens release button.

3. With the exception of the Canon Fish-eye 7.5mm f/5.6 lens, be sure to place the lens with its front end down (as illustrated) to avoid damaging the protruding pins.

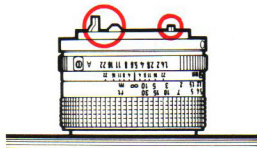

## 2. Loading the Batteries

## 3. Checking the Batteries

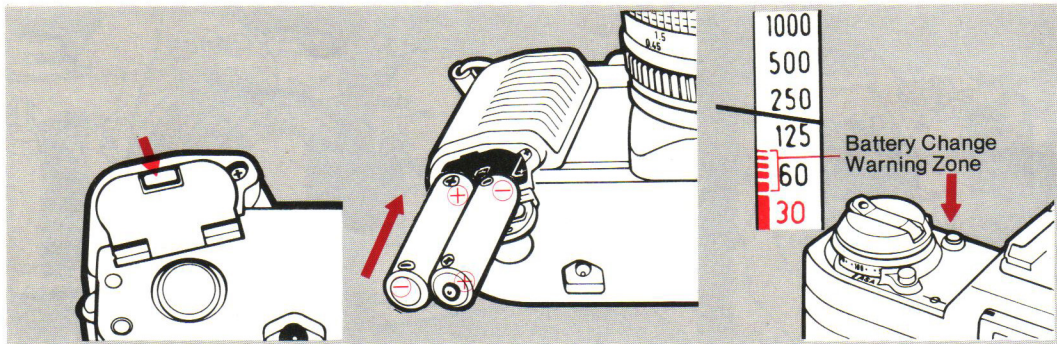

Push the battery chamber cover opening button. The battery chamber cover will flip open.

Load two new batteries so that their terminals are in the directions indicated by the diagram inside the battery chamber. The camera will not function if the batteries are loaded incorrectly.

Press the battery check button. Shooting is possible if you see the meter needle in the viewfinder swing up over the battery change warning zone. If there is not enough power, replace the batteries with new ones.

### Usable Batteries

ALKALINE BATTERY	Duracell size AAA MN2400
	EVEREADY size AAA NO. E92

1. The AL-1 will not work without batteries. We recommend carrying a spare set.
2. Don't touch the battery terminals. Wipe them and the camera contacts with a clean, dry cloth before loading to prevent poor contact from dirt.



## 4. Learning the Basic Operation

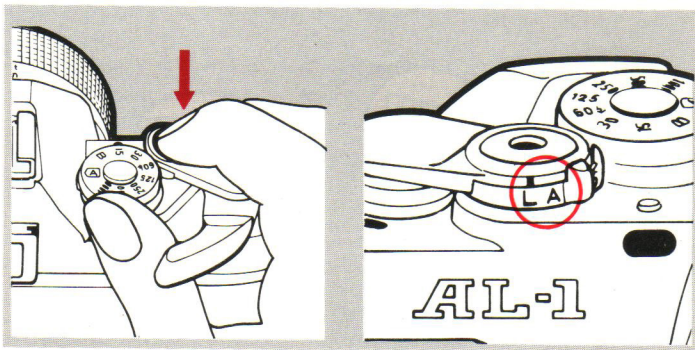

1. With normal use, the batteries should be good for more than 30 rolls of film (36 exposures).
2. It is necessary to take special precautions with the batteries when you are shooting in temperatures below 0°C (32°F).
3. Remove the batteries if you do not expect to use the camera for about three weeks or longer.

Turn the film advance lever in the direction of the arrow until it stops. You may turn it in a single-stroke or in several short strokes. When the film is loaded, this will advance it to the next frame.

The AL-1 has a two-step shutter button. Press it halfway to turn the meter on and to get a display in the viewfinder. Gently press it all the way down to release the shutter. You cannot release the shutter

again until the film is advanced.

Turn the shutter button lock lever to "L" to prevent accidental shutter release or battery drain whenever you are not using the camera. Never jab the shutter button! Pressing it gently is important for getting sharp pictures.

## 5. Setting the ASA

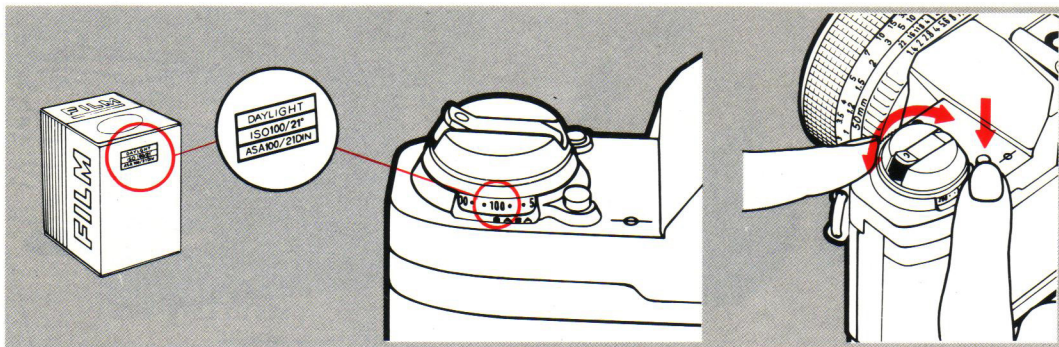

While pressing the lock release button, turn the ASA dial until the ASA speed of your film is aligned with the green index. This is necessary for getting correct exposure.

## 6. Loading the Film

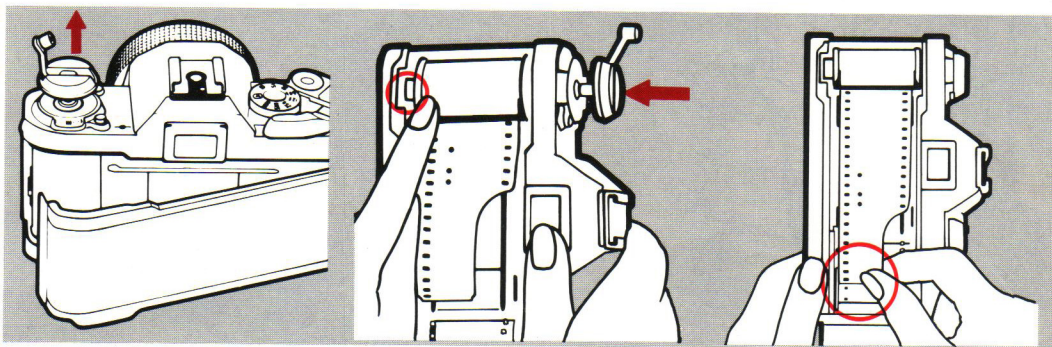

Pull up the rewind knob until the camera back pops open.

The AL-1 uses color (negative or slide) or black-and-white film in standard 35mm cartridges. Place the cartridge in the film chamber as shown. Then push the rewind knob down, turning it until it drops into its normal position.

Pull the film leader across the camera and insert it into any slot of the take-up spool.

A plastic insert is attached to the pressure plate of AL-1 to protect it in transport. Before loading the first film cartridge, remove this insert and throw it away.

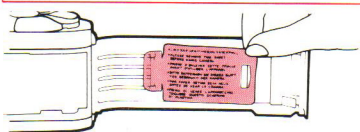

Shield the film from direct sunlight while loading.



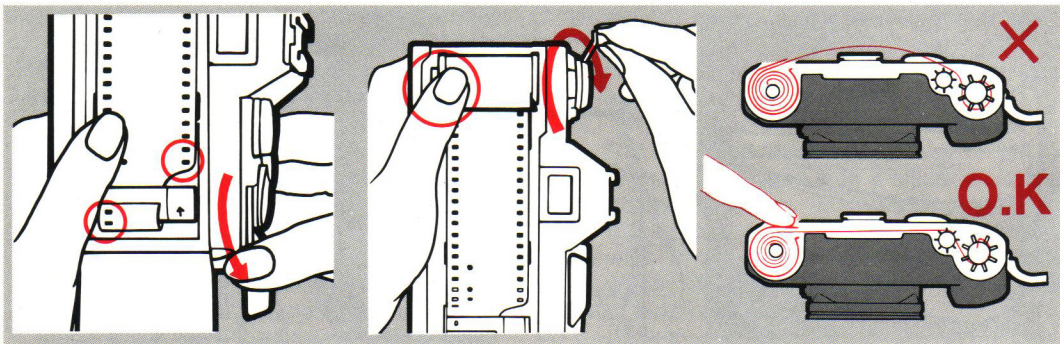

Advance the film once. Make sure the film perforations are engaged in the teeth of the film transport sprocket and the take-up spool.

The film should be taut. If there is slack, gently turn the rewind crank in the direction of the arrow until it stops. Then close the camera back.

While loading the film, take care not to touch the shutter curtain, the film rails or the pressure plate (shown in red).

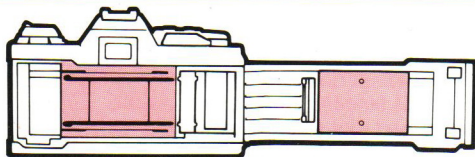

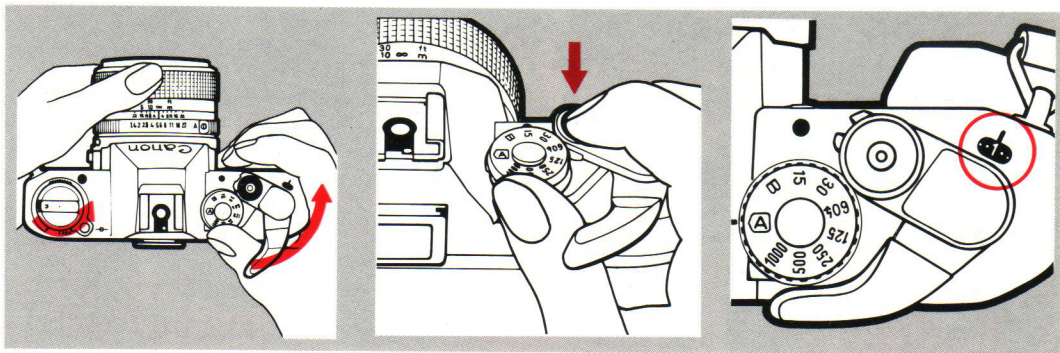

Take several blank shots, releasing the shutter and advancing the film, until the frame counter reads "1." While doing this, keep an eye on the rewind knob. If it rotates in the direction of the arrow, the film is loaded correctly.

Each time you advance the film, the frame counter also advances to the next frame. It can count up to 38 frames. The numbers 12, 20, 24 and 36 are in orange to call your attention to the fact that rolls with those numbers of frames are or are almost finished.



## 7. Learning to Hold the Camera Correctly

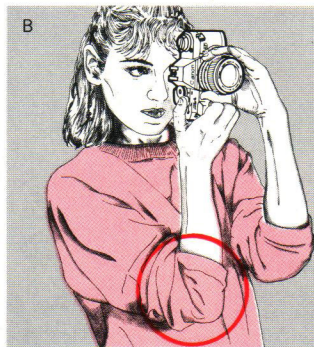
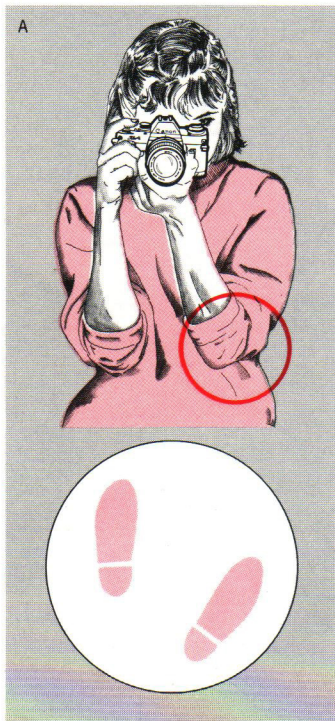

The slightest movement of your body during shutter release may cause blur in the picture. The best way to prevent camera movement is to hold the camera firmly, with your left hand supporting the camera and lens. Press your left elbow to your body and lightly press the camera against your cheek or forehead. For a vertical shot, steady at least one elbow against your body. Spread

your feet slightly apart, one foot ahead of the other, and relax. Lean against a steady support if one is available.

There is, of course, no one correct way to hold the camera. Experiment to find the most suitable way for you. Select a method that provides comfort in addition to stability. It may help to practice in front of a mirror.

## 8. AE Photography

### Setting the Selector Dial

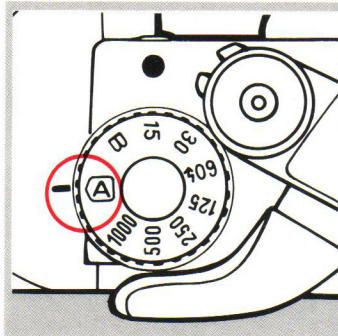

The AL-1 offers Aperture-priority AE and manual override.

For Aperture-priority AE, the selector dial must be set to "A."

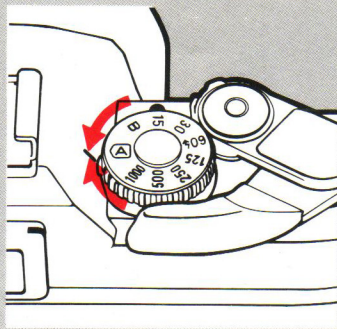

Once set, the dial automatically locks in this position.

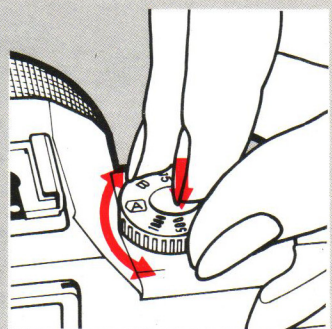

The other positions on the dial are all for special uses and will be explained in more detail later.

To remove the selector dial from "A," turn it while pressing the auto release button. The dial can be turned freely between the other positions.



## 9. One Shot at a Time

### Setting the Aperture

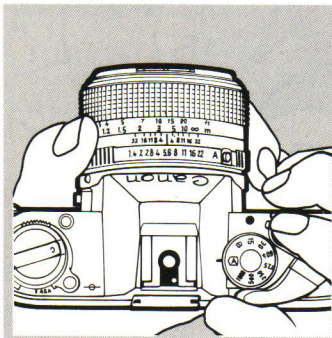

To set an aperture:  
With the selector dial at "A," simply turn the lens aperture ring until the desired f/stop is aligned with the aperture index. Intermediate setting is possible. For correct exposure, the camera will automatically select the shutter speed according to the film speed in use, lighting conditions, and f/stop you have set.

### Choosing an f/stop

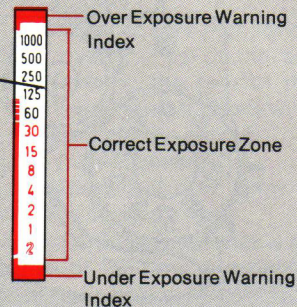
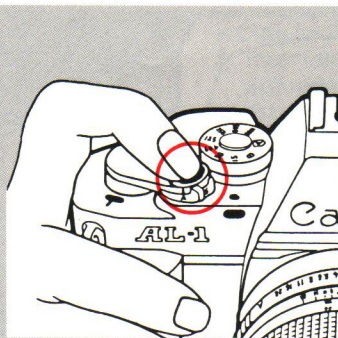

Use the following table as a guide when ASA 100 film is loaded.

Lighting Condition	f/stop
Indoors	1.8 2 2.8
Outdoors, Cloudy	4 5.6
Outdoors, Bright sunlight	8 11

After choosing an f/stop, look into the viewfinder and press the shutter button halfway. If the meter needle does not point to the red index at the very top or bottom of the shutter speed scale, exposure will be correct.

## Focusing

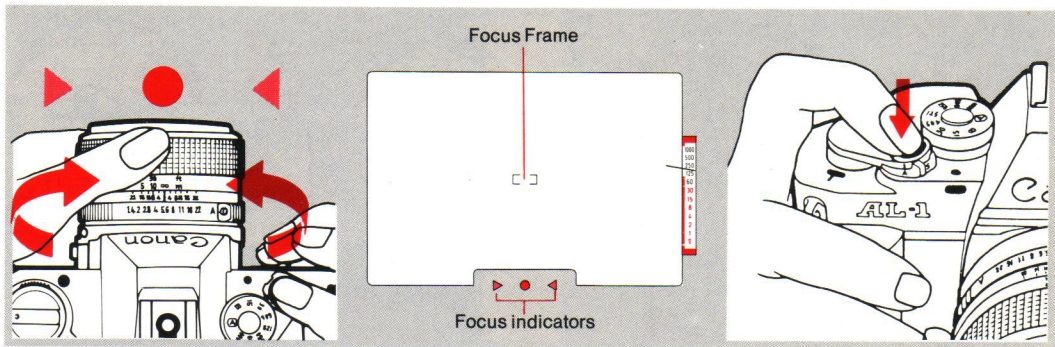

### Focusing

1. Turn the focusing ring while pressing the shutter button halfway.
2. A focus indicator will appear at the bottom of the viewfinder.
3. When you see a red arrow which means that the subject is out of focus, then turn the focusing ring in the direction of the arrow.
4. When the subject is in focus a green LED will appear instead of a red arrow.
5. Gently press the shutter button all the way down to take the picture.

Do not set the aperture ring to the "A" mark. If you do so the exposure will not be correct. Try to use a flash or a tripod when the needle points to a shutter speed slower than 1/30 sec. in order to avoid image blur.

\* If the subject is extremely out of focus no signal will appear.



## 10. Rewinding the Film

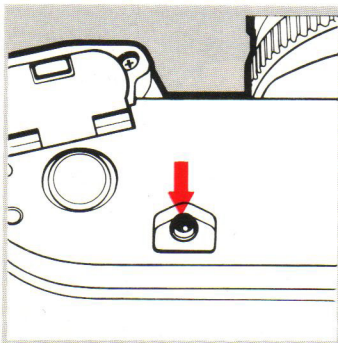

You can tell you have reached the end of the film when the frame counter does not move, and when the film advance lever will not turn partially or at all. To remove the film, first press in the rewind button.

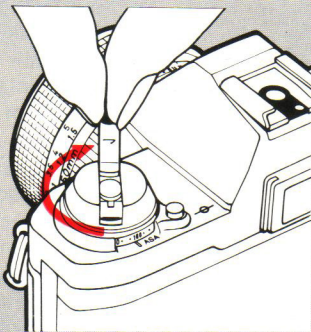

Next turn the rewind crank in the direction of the arrow.

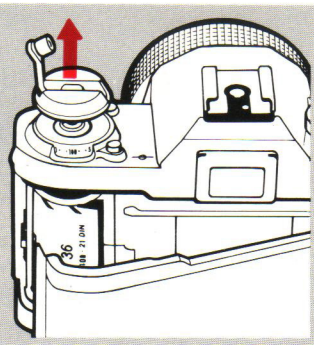

Then open the camera back, remove the film cartridge, and place it back in its canister. It should be developed as soon as possible.

**DO NOT** open the camera back until you have rewound the film back into the cartridge. If you do, light falling on the film may ruin all of the pictures.

## 11. Self-timer

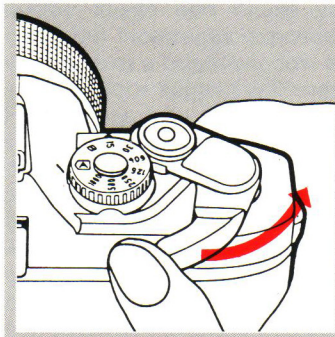

Advance the film to the next frame and focus your subject.

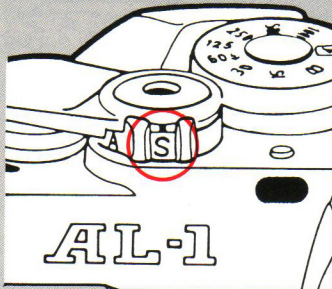

Set the shutter button lock lever to "S."



To start the self-timer, press the shutter button.



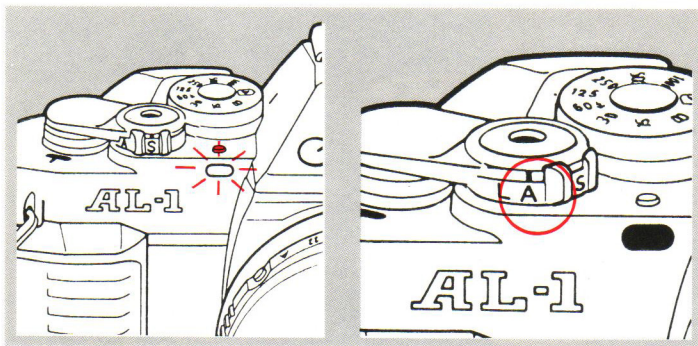

A red light (from the self-timer LED) will blink. The shutter will be released automatically ten seconds later. Before shutter release, the light will begin to blink at a faster rate.

1. The AL-1 sets the exposure the moment you press the shutter button. Do not stand in front of the lens while pressing the button, or exposure may be incorrect.
2. Following exposure, unless you want to use the self-timer for the next frame, reset the main switch to "A" or "L."
3. If you have started the self-timer and wish to cancel it before shutter release, press the battery check button or push the shutter button lock lever to "A" or "L."

## 12. Dedicated Flash Photography with a Canon Speedlite

### Automatic flash photography

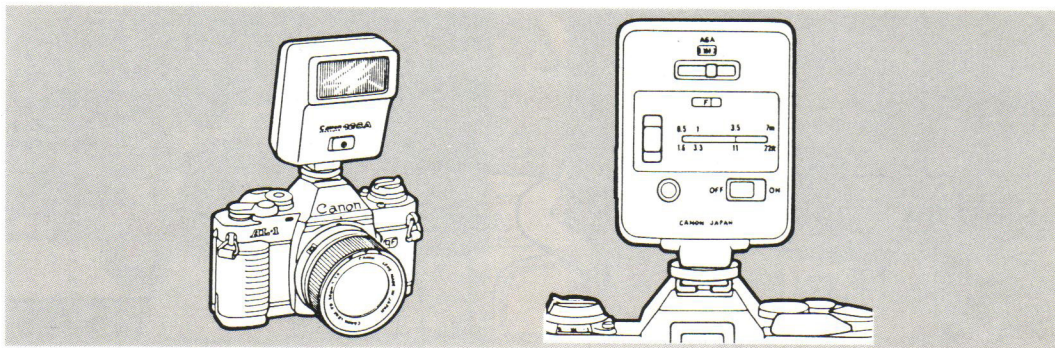

Set the aperture you have chosen on the Speedlite on the lens. When the flash is charged, its pilot lamp will glow and the shutter speed will be automatically set to 1/60 sec. The shutter speed dial can be set at any shutter speed except "B".

#### A-series Accessories

The AL-1, along with the A-1, AE-1PROGRAM, AE-1 and AV-1 is one of Canon's A-series cameras. Like these cameras, it accepts most of the A-series accessories, such as the Speedlites 011A, 133A, 155A, 166A, 177A, 188A or 199A and the Power winder A or A2. With these accessories, the AL-1 will do its best in poor lighting and fast-action shooting.



## 13. Carrying the Camera

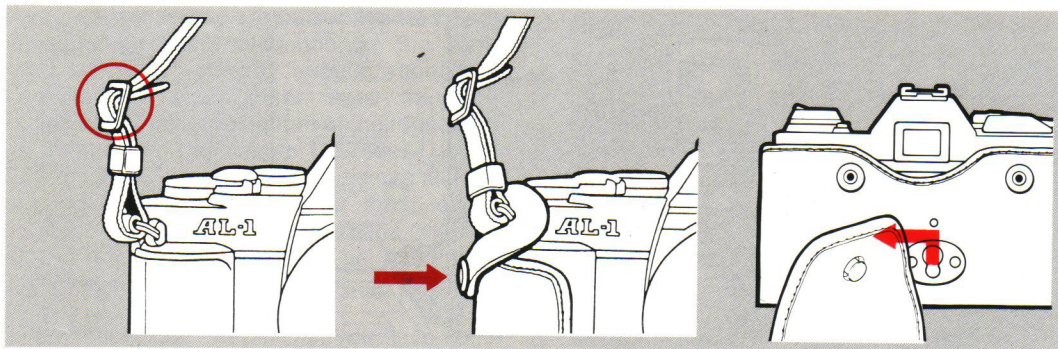

Thread the ends of the strap through the rings on the camera as shown.

For carrying the camera, in particular, insert it into its semi-hard case (optional accessory) as shown.

To remove the top cover, turn it down, then push it straight up and out. Turn the lens' focusing ring to infinity ( $\infty$ ) before closing the top cover.

Do not forget to turn the main switch to "L" to prevent accidental shutter release while carrying the camera.

## Pre-shooting Checklist

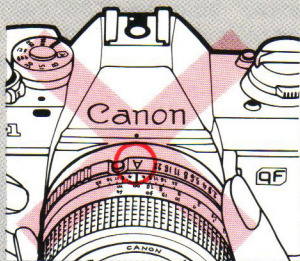

- Lens aperture ring off "A" mark?

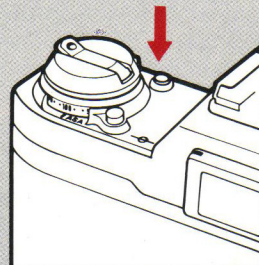

- Batteries?

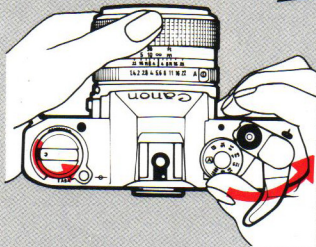

- Film completely advanced?

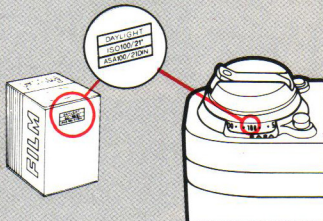

- ASA setting?

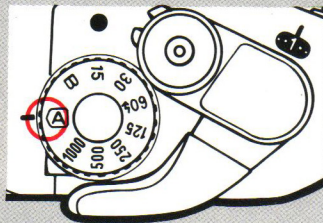

- The selector dial set to "A"?



## Care

Your AL-1 is a precision instrument. Regular use with proper care will ensure maximum performance. Reliable under normal use, it can be damaged by moisture, heat, shock, water, sand or the use

of force. We recommend periodic external cleaning with a blower brush and lens cleaning with lens cleaning tissue which has been moistened with a few drops of lens cleaning fluid. During pro-

longed storage, remove the camera from its case and wrap it in a clean, soft cloth. Remove the batteries. See p. 52 for additional tips on camera and lens care.





**AL-1**



*Quick Focus*

**Making the Most of  
Your AL-1**



## 14. Battery

### Usable Batteries

Use two brand-new batteries as specified in the table below or equivalent batteries of another brand.

ALKALINE BATTERY	Duracell size AAA MN2400
	EVEREADY size AAA NO. E92

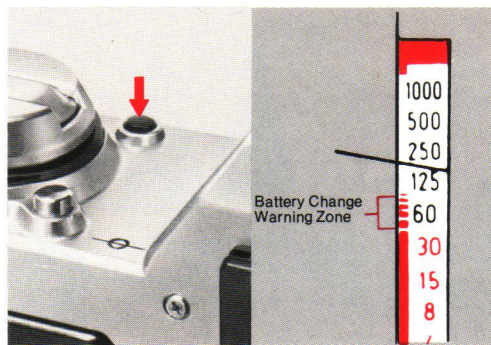

Check the power level of the batteries as follows:

1. Look into the viewfinder while pressing the battery check button on the top of the camera. When the battery check button is pressed, the meter needle in the viewfinder swings up.
2. The condition of the batteries depends on where the meter needle comes to rest. Refer to the following table:

Position of Meter Needle	Power Level
Above battery change warning zone	Good
In battery change warning zone	Battery power getting weaker but still good. Prepare new batteries.
Below battery change warning zone	Not enough. Change the batteries

Remove the batteries if you do not expect to use the camera for about three weeks or longer. With normal use, the batteries should be good for more than 30 rolls of film (36 exposures).

Do not try to take the batteries apart and never dispose of them in fire.

Ni-Cd batteries can not be used.

Battery power may decrease at temperatures below 0°C (32°F). In this case, load new batteries and keep the camera warm until you are ready to shoot. Do not throw the original batteries away; keep them as spares because they may work normally again at higher temperatures.





# 15. Viewfinder

## Viewfinder Information

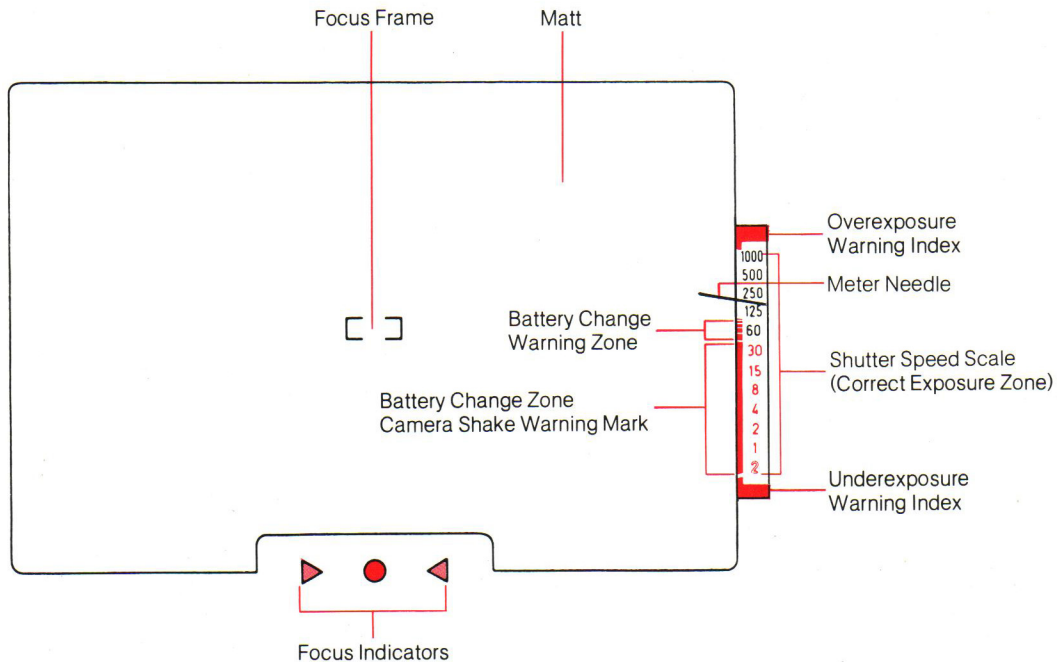

## **Focus Frame**

Look into the viewfinder and compose the picture so that your main subject covers the focus frame.

When you press the shutter button halfway a signal will appear. (Refer to p. 32 for subjects not suited for focusing.)

When the green dot lights up, the subject is in focus.

## **Exposure Warnings**

### **○ Overexposure Warning**

If the subject you want to shoot is too bright, the needle will touch the overexposure warning index. In this case turn the aperture ring to a smaller f/stop (larger number) so that the needle will point to the correct exposure zone.

### **○ Underexposure Warning**

If the subject you want to shoot is too dimly lit, the needle will touch the underexposure warning index. In that case turn the aperture ring to a larger f/stop (smaller number) so that the needle will point to the correct exposure zone.

When the shutter speed is slower than 1/30 sec. it is advisable to use a flash unit or a tripod to prevent image blur.

## 16. Subjects not Suited for the Quick-focus System of This Camera

The accuracy of the Quick-focus system is very high. However, there are some kinds of subjects which are not suited for the system.

### Subjects not suited for the system and how to focus them:

When the following subjects are in the focus frame, a focus signal may fail either to appear in the viewfinder (subjects 1-4), or to relay correct information (subject 5).

If this happens, try to compose the picture so that the focus frame covers a substitute subject, which is approximately the same distance as your main subject. Then try to focus judging from the sharpness of the image in the viewfinder. When the image looks the sharpest, the subject is in focus.

1. Subjects without vertical lines (window blinds, a series of waves in the ocean)... Fig.A
2. Subjects with little or no contrast (light-colored or white objects)... Fig.B
3. Subjects in low-light situations (usually noted by the camera shake warning mark)... Fig.C

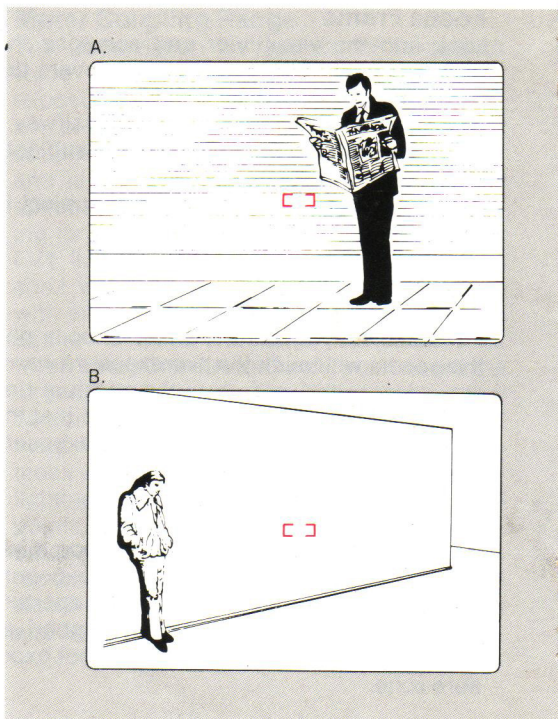



C.

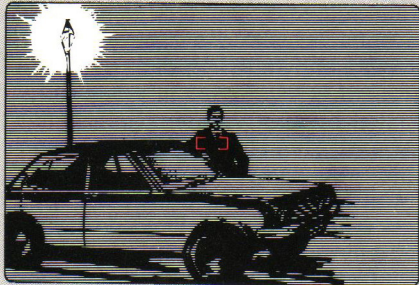

D.



4. Subjects with strong reflections or brightly backlit subjects.
5. Subjects with an object in front of them (zoo animals in a cage) . . . Fig.D

\* The darker the subject is, the slower an indicator will appear.

### Cases in which you can not use the focus indicators:

1. Photomacrography with magnifications of 5X and over; photomicrography; and when using Canon Macro Lens 20mm f/3.5.
2. If the effective aperture of the lens at the time of ranging is from f/8 to f/11. (Lenses with small maximum apertures or with the diaphragm stopped down.)
3. When a linear polarization filter is used.

In the above cases try to focus the subject judging from the sharpness of the image in the viewfinder as mentioned before.

## 17. AE Meter Coupling Range at Various Film Speeds

### Meter Coupling Range

The abbreviation EV stands for “exposure value” and indicates the total amount of exposure obtained with a certain combination of aperture and shutter speed. The meter coupling range is expressed in terms of EV and is limited by aperture, shutter and film speeds. The AL-1 meter is capable of metering for automatic exposure within a range of EV1 (f/1.4 at 1 sec.) to EV18 (f/22 at 1/500 sec.) when using ASA 100 film and a lens with an aperture scale of f/1.4 to f/22, such as the FD 50mm f/1.4 lens. This means that, when using this film and lens, you can get the largest total amount of auto exposure with a combination of f/1.4 at 1 sec. If the meter needle still points to the underexposure index with this combination, it means that the lighting is too dark. If the meter needle still points to the overexposure index with a combination of f/22 at 1/500 sec., the lighting is too bright. Please refer to the graph for the meter coupling range with other film speeds and aperture ranges.

EV	TV											
	2	1	1/2	1/4	1/8	1/15	1/30	1/60	1/120	1/250	1/500	1/1000
0	1.4	1.2										
1	2	1.4	1.2									
2	2.8	2	1.4	1.2								
3	4	2.8	2	1.4	1.2							
4	5.6	4	2.8	2	1.4	1.2						
5	8	5.6	4	2.8	2	1.4	1.2					
6	11	8	5.6	4	2.8	2	1.4	1.2				
7	16	11	8	5.6	4	2.8	2	1.4	1.2			
8	22	16	11	8	5.6	4	2.8	2	1.4	1.2		
9	32	22	16	11	8	5.6	4	2.8	2	1.4	1.2	
10		32	22	16	11	8	5.6	4	2.8	2	1.4	1.2
11			32	22	16	11	8	5.6	4	2.8	2	1.4
12				32	22	16	11	8	5.6	4	2.8	2
13					32	22	16	11	8	5.6	4	2.8
14						32	22	16	11	8	5.6	4
15							32	22	16	11	8	5.6
16								32	22	16	11	8
17									32	22	16	11
18										32	22	16



## 18. EXPOSURE



What's going on when you turn the aperture ring? Each time you move from one f/stop to the next smaller f/stop (larger number), the aperture becomes only half as big and the exposure is halved.

While the amount of light allowed to strike the film for exposure is controlled by the aperture size, the shutter speed regulates the amount of time the light strikes the film. Like f/stops, each time the shutter speed changes from one speed to the next faster speed (larger number), the exposure is halved.

However, the total amount of exposure necessary in any particular situation is fixed. This means that if you select the next smaller f/stop, the camera will automatically reduce the shutter speed one step to give the same exposure. Consequently, you can see that several different combinations of aperture and shutter speed give the same exposure.

## **The Finer Points of Selecting an Aperture**

If correct exposure is your only concern, you may simply select any f/stop as long as the meter needle does not point to one of the exposure warning indices. However, even if the image is exposed correctly, the feeling of the photo will vary greatly depending on which aperture you select.

### **Depth of Field**

Aperture has great influence on depth of field. The depth of field is the area in front of and behind the subject which is in focus at the same time as the subject. The smaller the f/stop, the greater the depth of field, i.e., the wider the range of sharpness from fore to background. Depth of field is greater at  $f/11$ , for instance, than it is at  $f/4$ . Depth of field is also governed by lens focal length and shooting distance. If the aperture and shooting distance remain the same, depth of field is greater the shorter the focal length. With aperture and focal length constant, depth of field is greater the greater the shooting distance. Generally, depth of field is also greater in the back than in the foreground.

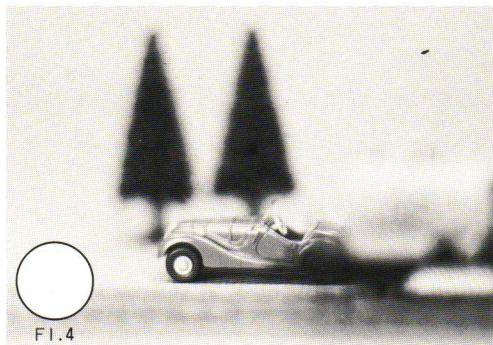

Using a small f/stop such as f/16 will give sharp overall focus and is very effective in landscape photography and any other kind of shot where great depth of field is preferable. On the other hand, a large f/stop such as f/1.4 will throw the background and foreground out of focus thereby emphasizing the subject. This is very effective in portraiture and for special effects. Please compare the two photos.

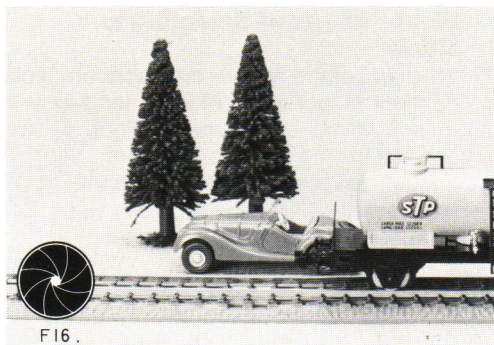



You can check the depth of field by using the depth-of-field scale which is a series of f/stops repeated on each side of the distance index on the lens barrel. The scale differs according to the lens. First focus your subject. Find the two f/stops on the depth of field scale which correspond to the aperture you have set for the exposure. Draw imaginary lines from these two f/stops to the distance scale. The effective depth of field extends between those two distances. For example, using a standard 50mm lens focused at 3m (10ft.) with the aperture set at f/11 depth of field extends from 2.2m (7.3ft.) to 6m (20ft.). Any subject from 2.4m to 4.5m away will be in reasonably sharp focus in the image.

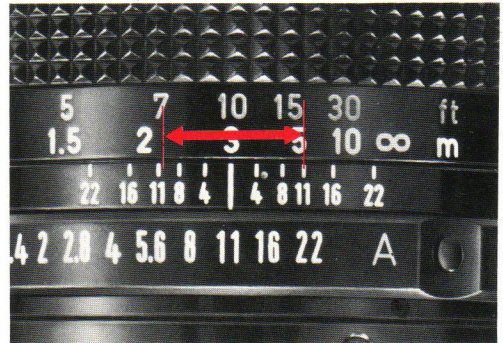

## Shutter Speed

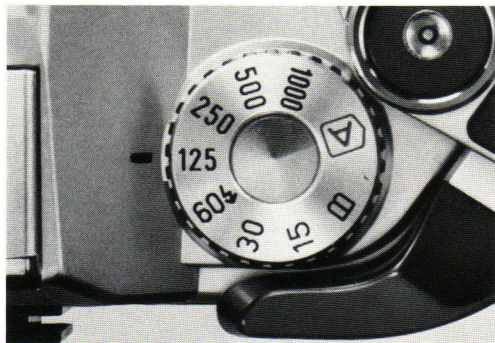

Lest it be forgotten, the aperture will also have a great effect on shutter speed. For some shots, the shutter speed which corresponds to the aperture you have selected may not be suitable. This is the case, for instance, when you want to take a hand-held shot and the meter needle points at or below the camera shake warning index.

The basic function of shutter speed is to provide correct exposure, but you can also use it to control the expression of your subject's motion and to control the effect of camera movement.



1/1000 sec.

### 1. Freezing Motion

The faster the subject is moving, the higher the shutter speed required to stop the action. To freeze the motion of a pedestrian, for example, choose a speed of at least 1/60 sec.; for a moving car, as fast as 1/1000 sec. The motion of the motorcycle in this photo was frozen at 1/1000 sec.





## 2. Blurring the Subject's Motion

Blurring part of the picture can give a convincing sense of action. To blur the subject, simply set a shutter speed which is too slow to freeze its action. In this photo it was blurred at 1/125 sec.



## 3. Panning

You can blur the background while keeping the subject relatively sharp by "panning." Choose a shutter speed suitable for the subject's motion and release the shutter as you follow the movement, turning the upper part of your body.

## 19. Shooting with Light Behind

### Exposure Correction

If you want to forego a tripod with a telephoto lens and try hand-held shooting, the minimum shutter speed should, generally speaking, be equal to or faster than the reciprocal of the focal length of the lens. With an 85mm lens, this means 1/125sec., with a 200mm lens, 1/250sec. This rule can also be applied generally to all other focal length lenses. In some cases, perhaps slightly slower shutter speeds may be used with wide-angle lenses.

In any case, don't forget that you have complete control over shutter speed with your AL-1. Simply turn the aperture ring to a smaller f/stop to reduce the shutter speed or to a larger f/stop to raise the shutter speed. You can easily confirm the shutter speed in the viewfinder by pressing the shutter button halfway.



Do your prints or slides ever come out too light or dark, even if you were sure there was sufficient light when you made the exposure? Under- and overexposure are some of the most common mistakes in photography. Although sometimes a result of using damaged film, or of setting the wrong ASA speed, under- and overexposure are more often than not caused by failing to compensate for extreme lighting conditions. Under extreme lighting conditions (when your subject stands against either very bright or very dim backgrounds), the AL-1's meter may be overinfluenced by the light or darkness of the

## Your Subject (and Other Unusual Lighting Situations)

overall image and cause your subject to come out incorrectly exposed. For example, if the sun or a bright window are behind your subject, your subject will come out too dark. Fortunately, you can avoid such mistakes with the AL-1 and correct exposure by: 1) pressing the backlight control switch; 2) adjusting the ASA; or 3) manually setting both the shutter speed and aperture (cancelling AE photography). If your subject stands against a very dark background, in a theater or concert hall, for example, exposure can be corrected by the above numbers 2) and 3).

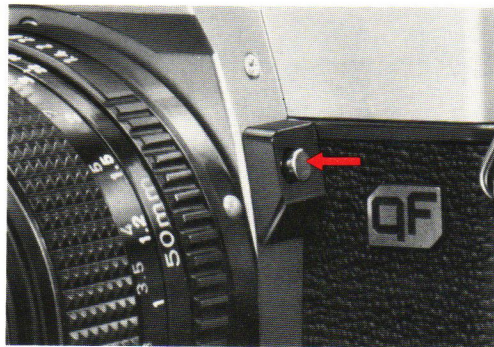

### 1. Backlight Control Switch

When you press this switch, the camera automatically reduces the shutter speed 1-1/2 steps to increase exposure. This is useful in all those cases described above in which you would like to give your subject a little more exposure, such as in backlit situations. Since the shutter speed is considerably reduced, make sure to check the shutter speed in the viewfinder before shooting, and be certain that the meter needle does not point to the underexposure index. It may be necessary to turn the aperture ring to a larger



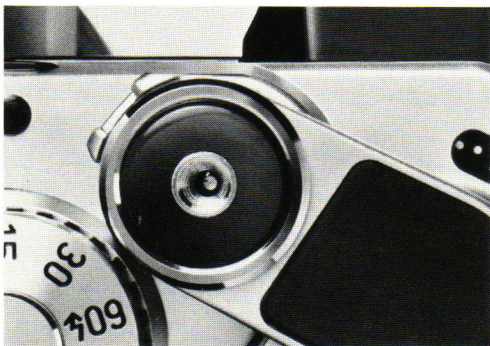

f/stop to permit hand-held shooting and correct exposure. Please note that you must keep pressing this switch until after you release the shutter button. It does not lock.

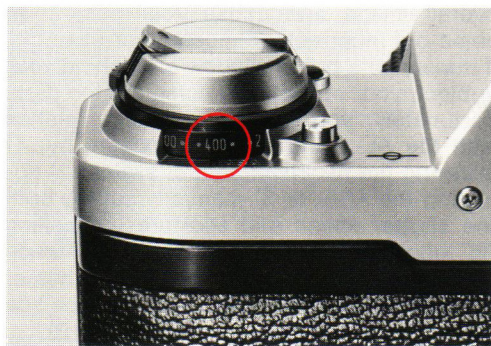

## 2. Adjusting the ASA

Most likely, you will want to use the backlight control switch to correct exposure when your subject stands against very bright backgrounds. It is a more convenient method than adjusting the ASA film speed.

However, when you photograph subjects in dark places (theaters, etc.), you must correct exposure by either adjusting the ASA film speed, or by switching to manual override. If you decide to correct exposure under these conditions by adjusting the ASA film speed, turn the ASA lever to a higher number. Each full step on the ASA film speed scale equals

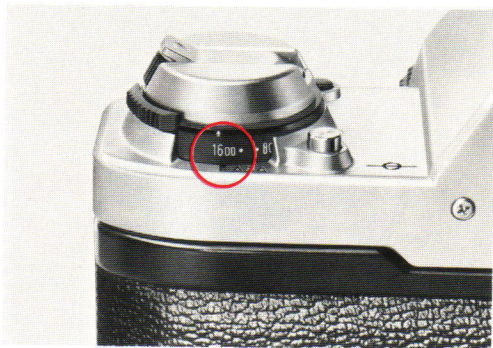

one f/stop. If ASA 200 film is loaded, for instance, and you turn the lever to ASA 400, your subject will receive one f/stop less exposure. Exactly how much higher you should set the ASA film speed depends on various conditions. Generally, a subject against a dark background requires one less f/stop for correct exposure, but to be safe, you may wish to bracket the exposure by taking several shots above and below the doubled film speed number.

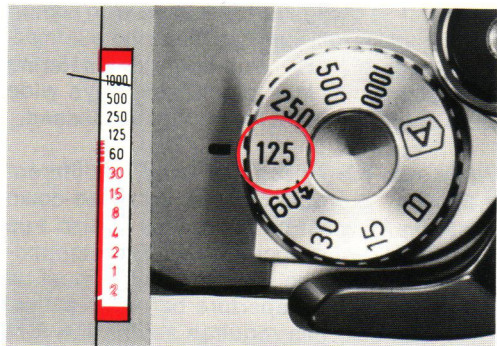

### 3. Manual Override

Instead of using the backlight control switch or changing the ASA, you can also make an exposure correction by canceling AE photography. When you do this, you will be setting both shutter speed and aperture by yourself. This is called manual override and is useful whenever you want to set a different shutter speed than the one the AL-1 would select automatically in AE.

## 20. STOPPED-DOWN METERING AE

The AL-1 is designed to be used with Canon FD lenses for full-aperture metering automatic exposure (AE). Full-aperture metering means that the lens diaphragm stays wide open until the instant the shutter is released.

When non-FD lenses are used, a different metering method called stopped-down metering AE must be used. This is also true for non-FD lens accessories. For stopped-down metering, the lens diaphragm must be set to the desired aperture before metering. On FL lenses, this requires setting the A-M ring to the M mark. When this system is used the viewfinder brightness will vary with the aperture set. The lens should be fully open for focusing and then stopped down just before shutter release for metering. Although lens operation is different in this mode, the operation of the camera is identical to the full-aperture metering AE mode.

With few exceptions (noted in the instructions for the accessory), stopped-down metering is necessary whenever you insert an accessory between the camera and lens for close-up photography.

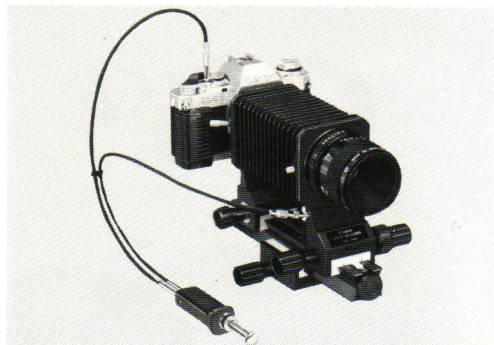

1. If you insert an accessory designed for AUTOMATIC diaphragm control, such as the Auto Bellows or Bellows FL, between the camera and ANY lens, follow the steps for stopped-down metering.



Lenses which cannot be mounted on the AL-1

- FL 19mm f/3.5
- FL 58mm f/1.2
- R 58mm f/1.2
- R 100mm f/3.5
- FLP 38mm f/2.8

Lenses which cannot be used with the AL-1's meter for mechanical reasons:

- FL 50mm f/1.8
- FL 35mm f/2.5
- R 50mm f/1.8
- R 35mm f/2.5
- R 100mm f/2

NEVER try to do stopped-down metering with an FD lens unless there are close-up accessories between it and the camera. If you do stopped-down metering when an FD lens is mounted directly on the camera, exposure may not be correct.

**Note**

The instructions with the accessory will tell you whether or not manual diaphragm control is necessary. The procedure differs according to the type of lens.

## Manual Diaphragm Control

FD Lenses without Chrome Mount Ring, except for FD Macro Lenses:

1. Insert the slot of the accessory manual diaphragm adapter over the tip of the automatic aperture lever at the rear of the lens. Push the lever counterclockwise and lower the adapter into the groove.
2. Mount the lens on the accessory.  
The diaphragm blades will now open or close as you turn the aperture ring.  
When the manual diaphragm adapter is attached, never mount the lens directly on the camera or on an accessory designed for automatic diaphragm control, such as the Auto Bellows or Bellows FL.

FD Lenses with Chrome Mount Ring and FD Macro Lenses (except for FD 200mm f/4 Macro Lens):

1. Push the automatic aperture lever at the rear of the lens counterclockwise until it automatically locks.
2. Mount the lens on the accessory.



## Film Plane Indicator

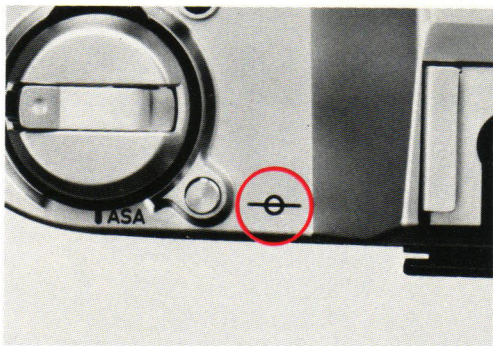

### Note

Some of these lenses have an additional lock lever. With these lenses, push the automatic aperture lever fully counterclockwise, then push the lock lever to "L."

Be sure to reset the automatic aperture lever to its normal position before mounting the lens directly on the camera. In the case of a lens with a lock lever, switch it back to the position of the white dot.

This mark, engraved on top of the camera body, indicates the exact position of the film plane. It is useful for measuring the exact shooting distance from film to subject in close-up photography. Distances on the lens' distance scale are calibrated from this mark. It is not used in general photography.

### Note

The aperture ring of an FD lens must be removed from "A" before you mount the lens on any of these close-up accessories except for FD-U Extension Tubes and Extenders FD 2X and FD 1.4X, which are designed for normal full-aperture metering.



## 21. Shooting with Infrared Film

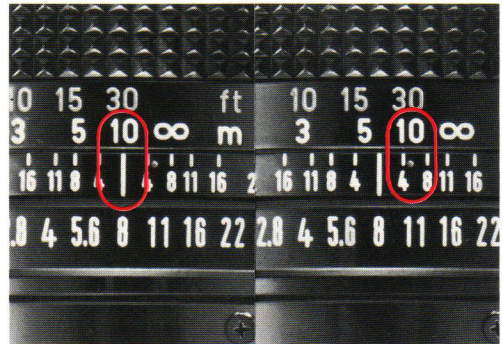

When you load the AL-1 with black-and-white infrared film, it is necessary to make a slight adjustment in focus. A red infrared index is engraved on most Canon lenses for this purpose. First focus as usual through the viewfinder. Then read the distance on the lens' distance index and turn the focusing ring to align that distance with the infrared index. It will also be necessary to use a deep red filter, as specified by the film manufacturer, over the lens. For further details, follow the instructions of the film manufacturer.



## With Other Flash Units (60 $\frac{1}{60}$ )

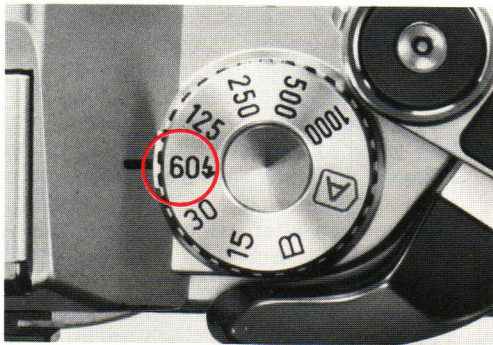

The flash must be designed to synchronize with the camera's shutter at a speed of 1/60 sec. Set the AL-1's selector dial to 60  $\frac{1}{60}$  . This will set the shutter speed to 1/60 sec. For special effects, the selector dial may be set to "B" instead of 60  $\frac{1}{60}$  .

## Bulb

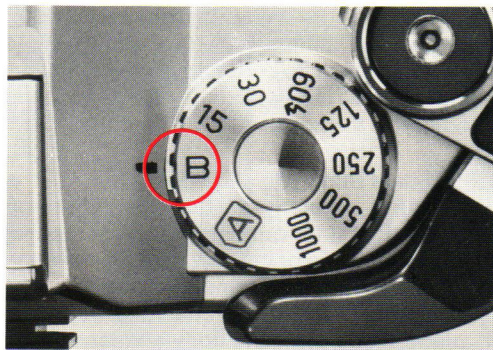

When shooting requires a shutter speed slower than 2 sec, set the shutter speed dial at B (Bulb). When the shutter speed is at "B," the shutter will remain open while you press the shutter button. It is best to use a tripod and a cable release when using "B."

## 22. Caring for your Camera

As with any precision instrument, proper care and maintenance involve a few simple rules in addition to common sense. Observing these few rules will keep your AL-1 in top condition at all times.

1. The best thing you can do for your AL-1 is to use it regularly. In the event that you must store it for quite a while, first remove it from its case or camera bag. Remove the battery. Wrap the camera in a clean, soft cloth and place it in a cool, dry, dust-free place. If you store the body and lens separately, attach both the body and rear lens caps.
2. Keep the camera and lens out of direct sunlight and away from "hot spots," such as the trunk, rear window shelf or glove compartment of a car. Do not store the camera in a laboratory or other areas where chemicals may cause corrosion.
3. To keep the camera in top condition during prolonged storage, occasionally insert the battery and take several blank shots to "exercise" the mechanisms. Check the operation of each part before you use the camera following long storage.
4. Water, spray, excessive humidity, dust and sand are your camera's worst enemies. Clean it especially well immediately after you use it at the beach.
5. To clean the exterior of the camera body, first blow off dust with a blower brush. Wipe off smudges with a silicone cloth or chamois leather. If smudges remain on the eyepiece after using a blower brush, wipe it lightly with lens cleaning tissue which has been moistened with a couple of drops of lens cleaner.
6. If the lens surfaces are clean, yet the viewfinder appears dusty, the picture will not be affected by the dust in the viewfinder. If the mirror gets dirty, it will not affect pictures but it may make viewing difficult. Dust it VERY gently with a blower brush. If further cleaning is necessary, NEVER do it yourself but take the camera to the nearest authorized Canon service facility.
7. The film chamber needs cleaning from time to time to remove film dust which may scratch the film. Gently dust it out with a blower brush. Be careful NEVER to press on the film rails, shutter curtain and pressure plate.

8. To clean the lens surfaces, use only a blower brush, cleaning fluid and tissue made specially for cleaning camera lenses. Carefully follow the lens' instructions. Chamois leather or a silicone cloth may be used for wiping smudges off the lens barrel—NEVER use such cloths on the glass surfaces!



## 23. Accessories

### Power Winder A or A2



The Power Winder A or A2 attaches to the AL-1 with a turn of a screw where it matches the camera's compactness to a tee. They give a choice of two modes: single-frame shooting with automatic film winding or continuous shooting in which the film is wound and the shutter recocked automatically at about two frames per second. Either way, the power winders couple with the AL-1 at any shutter speed from 2 sec. to 1/1000 sec. These are extremely popular accessories which are especially handy for taking sequential action shots, as in sports and fashion photography.

### Lens Hood

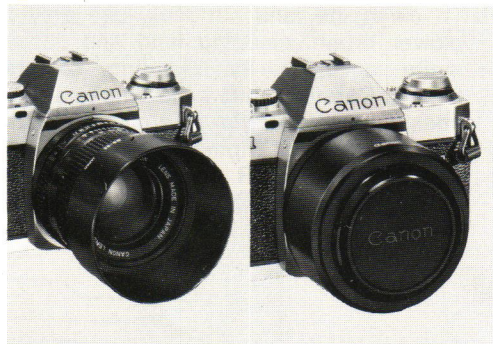

We strongly recommend the use of a lens hood to keep out side light which may cause flare and ghost images to form on the image. Rigid Canon hoods also help to protect the lens from shock. Use only a hood which is specified for your particular lens. Most Canon hoods fit into the bayonet mount and are fixed by turning. For more details, please see the lens' instructions.

## Dioptic Adjustment Lenses S

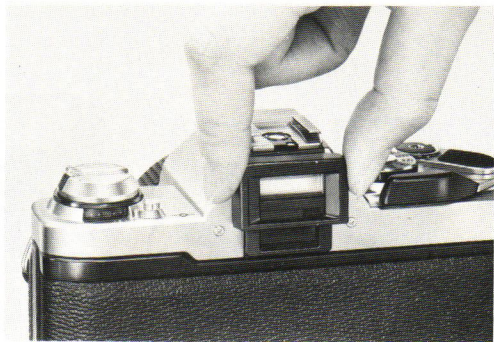

Ten eyesight correction lenses are available in the powers of +3, +2, +1.5, +1, +0.5, 0, -0.5, -2, -3 and -4 diopters. They may make viewing and focusing easier if you are near- or far-sighted. Choose the one which is closest to your eyeglass prescription, and make a practical test if possible.

## Close-up photography system

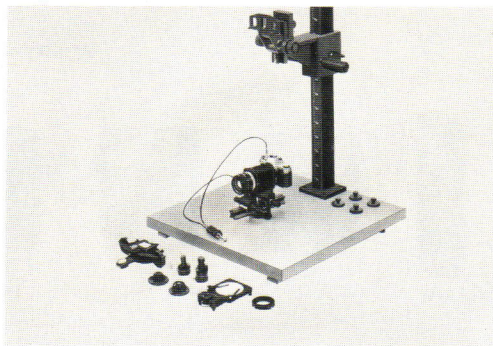

This system (including the Canon Auto Bellows and Copy Stand) is designed for close-up photography, copying and macro photography.

## Speedlites 011A, 133A, 155A, 166A, 177A, 188A, 199A, 533G and 577G

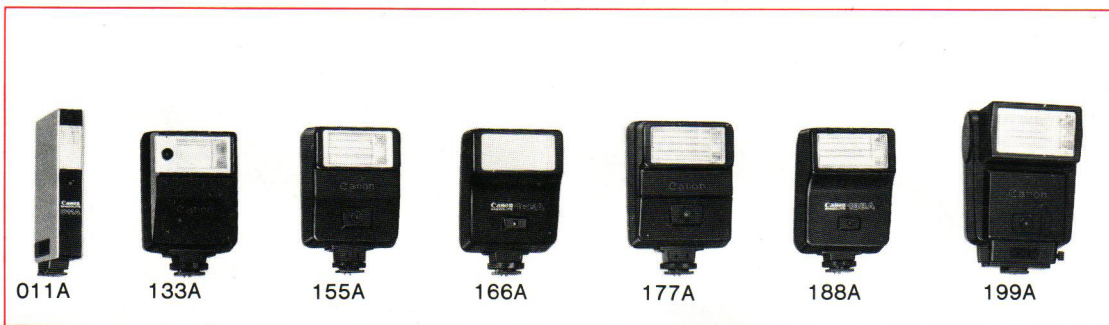

	<b>011A</b>	<b>133A</b>	<b>155A</b>	<b>166A</b>	<b>177A</b>
Guide No. (m·ASA100)	14	16	17	20	25
Flash coverage (mm)	35	35	35	35	35
Recycling time	less than 9 secs.	less than 9 secs.	less than 7 secs.	less than 7 secs.	less than 8 secs.
Number of Flashes	more than 150 times	more than 100 times	more than 300 times	more than 250 times	more than 200 times
Auto/Manu Switch	F4	F4	*F2.8, 5.6 Manu	*F2.8, 5.6 Manu	*F2.8, 5.6 Manu
Auto Distance Ranges	0.5 ~ 7	0.5 ~ 8	0.5 ~ 6	0.5 ~ 7	0.5 ~ 9
Film Speed Scale	100, 400	100, 400	25 ~ 800	25 ~ 800	25 ~ 800
Power Source	AA-Size Ni-Cd	AA-Size Ni-Cd	AA-Size Ni-Cd	AA-Size Ni-Cd	AA-Size Ni-Cd
Wide Adapter	None	None	None	None	One

\*: ASA100



## Canon Macrolite ML-1



533G



577G



188A	199A	533G	577G
25	30	36	48
35	35	35	35
less than 8 secs.	less than 10 secs.	less than 10 secs.	less than 6 secs.
more than 200 times	more than 100 times	more than 120 times	more than 250 times
*F2.8, 5.6 Manu	*F2.8, 5.6 Manu	*F2.8, 5.6, 11	*F2.8, 5.6, 11 Manu
0.5~9	0.5~10.6	1~12.8	1~17
25~800	25~800	25~800	25~800
AA-Size Ni-Cd	AA-Size Ni-Cd	AA-Size Ni-Cd Transistor Pack G	Ni-Cd Transistor Pack G
One	One	Two	Two

Canon Macrolite ML-1 is designed for close-up photography. This device is especially suited for macrophotography of insects or small animals in motion.

## 24. SPECIFICATIONS

**Type:** 35mm SLR (Single-lens Reflex) camera with electronically controlled AE (Automatic Exposure).

**Format:** 24 × 36mm.

**Usable Lenses:** Canon FD (for full aperture AE) and most FL (for stopped-down AE) series lenses.

**Viewfinder:** Fixed eye-level pentaprism.

**Field of View:** 92% vertical and 93% horizontal coverage of the actual picture area.

**Magnification:** 0.87X at infinity with a standard 50mm lens.

**Viewfinder Information:** Focus frame, focus indicators, shutter speed scale, meter needle, red over and underexposure warning indices and battery check/camera shake warning index.

**AE Mechanism:** Aperture priority AE control.

**Shutter:** Cloth, focal plane shutter. Electronically controlled.

**Shutter Button:** Electromagnetic, two-step button. Pressing it halfway activates the meter and the Quick-focus system; pressing it all the way sets shutter in operation. With lock and cable release socket.

**Shutter Speed:** Automatically controlled, steplessly, from 2 sec. to 1/1000 sec.

Manual settings for 1/1000, 1/500, 1/250, 1/125, 1/60  $\frac{1}{2}$ , 1/30, 1/15 sec. and B.

**Meter Coupling Range:** EV1 (1 sec. at f/1.4) to EV18 (1/500 sec. at f/22) with ASA 100 film and the FD 50mm f/1.4 lens.

**Metering Range:** EV3.5—EV18

**Film Speed Scale:** ASA25—1600

**Backlight Control Switch:** Shutter speed is automatically reduced 1-1/2 steps to increase exposure by pressing backlight control switch.

**Flash Synchronization:** At 1/60 sec. Set by switching selector dial to 60 for flashes other than a Canon Speedlite Direct contact at accessory shoe.

**Mirror:** Large instant-return type with shock-absorbing mechanism and Computer aided pattern.

**Self-timer:** Electronically controlled. Ten-second time lag activated by pressing shutter button. Red LED blinks to indicate operation; flashing frequency increases two sec. before shutter release.

**Automatic Flash Control:** With Canon speedlite 011A, 133A, 155A, 166A, 177A, 188A, 199A, 533G or 577G. With selector dial at "A," shutter speed set to 1/60 sec. automatically. Aperture set manually on aperture ring to same aperture set on flash.

**Light Metering System:** Through-the-lens (TTL), Center-weighted average by silicon photocell (SPC).

**Camera Back:** Fixed. Opened by pulling up rewind knob.

**Film Loading:** Via multi-slot take-up spool.

**Film Advance Lever:** Single-stroke 120° throw with 30° stand-off. Winding with several short strokes possible. Automatic winding possible with optional Power Winder A.

**Frame Counter:** Additive type. Automatically resets to "S" upon opening back cover.

**Film Rewind:** By pressing rewind button and cranking rewind knob.

**Focus Signal:** 3 ways with LED (Light Emitting Diode)

**Power Source:** Two 1.5V alkaline manganese (Size AAA, LR03) batteries

**Dimensions:** 142.1 × 86.5 × 47.6mm  
(5-9/16" × 3-3/8" × 1-7/8") 490g  
(17-5/160 ozs) camera body only

**Subject to change without notice.**





For your own convenience you may want to use this form to fill in the serial numbers of your AL-1 equipment for quick reference in the event of loss or theft.

Name of the Camera: **Canon AL-1**

Body Number:

Lens:            mm.     f:            No.    mm.     f:     N  
\_\_\_\_\_ o.

\_\_\_\_\_ mm.     f:            No.

Name:    Telephone Number:

Address:

Additional Accessories:







# Canon

**CANON INC.** 7-1, Nishi-Shinjuku 2-Chome, Shinjuku-ku, Tokyo 160, Japan  
Mailing address: P.O. Box 5050, Dai-ichi Seimei Building, Tokyo 160, Japan

- U.S.A. — **CANON U.S.A., INC. HEADQUARTERS**  
One Canon Plaza, Lake Success, N.Y. 11042, U.S.A.  
**CANON U.S.A., INC. MANHATTAN SERVICE CENTER**  
600 Third Avenue, New York, N.Y. 10016, U.S.A.  
**CANON U.S.A., INC. ATLANTA BRANCH**  
6380 Peachtree Industrial Blvd., Norcross, Georgia 30071, U.S.A.  
**CANON U.S.A., INC. CHICAGO BRANCH**  
140 Industrial Drive, Elmhurst, Illinois 60126, U.S.A.  
**CANON U.S.A., INC. LOS ANGELES BRANCH**  
123 Paulerino Avenue East, Costa Mesa, California 92626, U.S.A.  
**CANON U.S.A., INC. LOS ANGELES SERVICE CENTER**  
3321 Wilshire Blvd., Los Angeles, California 90010, U.S.A.  
**CANON U.S.A., INC. SAN FRANCISCO OFFICE**  
776 Market Street, San Francisco, California 94102, U.S.A.  
**CANON U.S.A., INC. HONOLULU OFFICE**  
Bldg. B-2, 1050 Ala Moana Blvd., Honolulu, Hawaii 96814, U.S.A.
- CANADA — **CANON CANADA INC. HEADQUARTERS**  
3245 American Drive, Mississauga, Ontario L4V 1N4, Canada  
**CANON CANADA INC. MONTREAL SERVICE CENTRE**  
10652 Côte de Liesse, Lachine, Quebec H8T 1A5, Canada  
**CANON CANADA INC. CALGARY OFFICE**  
2828, 16th Street, N.E. Calgary, Alberta T2E 7K7, Canada  
**CANON CANADA INC. EDMONTON SERVICE CENTRE**  
5222-86 St. Edmonton, Alberta T6E 5J6, Canada
- EUROPE, AFRICA  
& MIDDLE EAST — **CANON EUROPA N.V.**  
P.O. Box 7307, 1008 AC Amsterdam, The Netherlands  
**CANON FRANCE-PHOTO CINEMA S.A.**  
30, boulevard Vital-Bouhot, Ile de la Jatte, 92521 Neuilly-sur-Seine, France  
**CANON UK LTD.**  
Units 4 & 5, Brent Trading Centre, North Circular Road, London NW10 0JF, United Kingdom
- CENTRAL &  
SOUTH AMERICA — **CANON LATIN AMERICA, INC. DEPTO. DE VENTAS**  
Apartado 7022, Panamá 5, República de Panamá  
**CANON LATIN AMERICA, INC. CENTRO DE SERVICIO Y REPARACION**  
Apartado 2019, Zona Libre de Colón, República de Panamá
- SOUTHEAST ASIA — **CANON HONGKONG TRADING CO., LTD.**  
Golden Bear Industrial Centre, 7/F., 66-62 Che Wan Kok Street,  
Tsuen Wan, New Territories, Kowloon, Hong Kong  
**CANON SINGAPORE PTE. LTD.**  
Unit 605, Delta House, 2, Alexandra Road, Singapore 0315
- OCEANIA — **CANON AUSTRALIA PTY. LTD.**  
22 Lambs Road, Artarmon, N.S.W. 2064, Australia
- JAPAN — **CANON SALES CO., INC.**  
11-28, Kita, 3-Chome, Minato-ku, Tokyo 108, Japan