

# WILSONWERKS ARCHIVES

This camera manual is for reference and historical purposes, all rights reserved.

This cover page is copyrighted material. This document may not be sold or distributed without the express consent of the publisher.

©2008 wilsonwerks Llc

# Canon F-1



**E**

INSTRUCTIONS



Welcome to the large family of well satisfied F-1 owners. The F-1, along with its seemingly endless array of features and accessories for use in the home, the laboratory or for professional work, is the product of many years of studious research coupled with the development of Canon's superior camera technology. The Canon F-1 epitomizes the high quality and performance standards that Canon prides itself in. We at Canon hope that you make the most of your new F-1 and have many rewarding experiences with your F-1 system.

### **Before Using . . .**

Please read this instruction booklet thoroughly, familiarizing yourself carefully with the F-1, master the basic functions of the camera completely and you will be ready to fully utilize your new F-1.



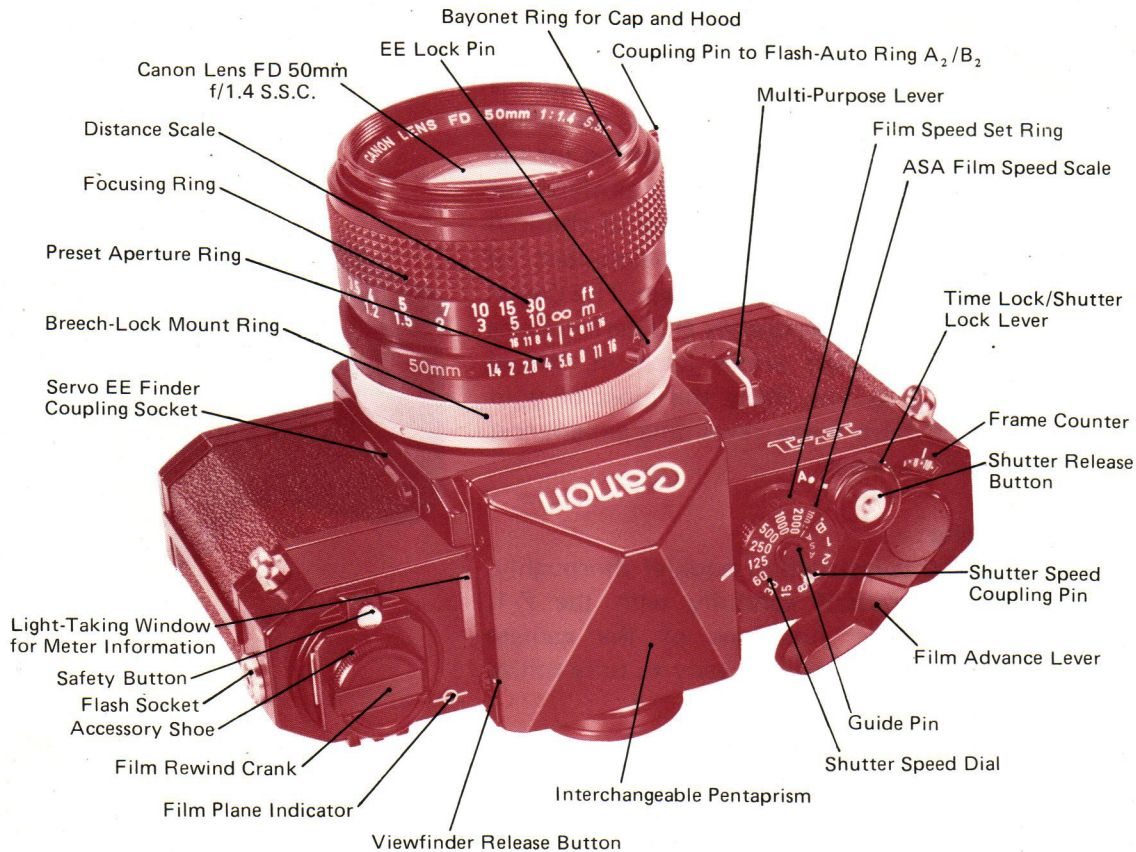

## Canon F-1 System

The system built around the F-1, from its initial stages, is designed to satisfy all possible photographic needs. Both versatility and variety were prime concerns for Canon's planning and designing staff. The system's ten thousand component parts are all built with a degree of accuracy which the complete interchangeability of the system requires. Furthermore, tests have demonstrated that the reliability of the Canon F-1 and its accessories is to an extent as of yet unmatched by any other product in the photographic industry. The F-1's accessories, including powerful motor drive systems, a unique Servo EE Finder, the Booster T Finder for dim light situations, the Film Chamber 250 and the incomparable FD series of interchangeable lenses, lend the versatility to the F-1 that makes the F-1 and all-embracing photographic system.







## Four Main Accessories



- Canon Booster T Finder with electronic timer for insufficient light photography
  - Canon Servo EE Finder for shutter priority EE photography
  - Canon Motor Drive Unit and Motor Drive MF for timer photography and high speed photography.
  - Canon Film Chamber 250 for shooting 250 frames
- Unmanned photography is possible in combination of these accessories.



\*For details, please refer to pages 49-52.

# Contents

Technical Data .....	8
Mercury Battery Loading and Checking .....	12
Film Loading .....	15
Film Winding .....	18
Shutter and Aperture Adjustment .....	20
Using the Built-in Exposure Meter .....	24
Exposure Settings .....	26
Coupling Range of Built-in Exposure Meter .....	29
Holding the Camera .....	30
Viewing and Focusing .....	31
Film Rewinding .....	34
Uses of Lenses .....	35
Interchangeable Lenses FD/FL .....	41
Synchronizing Flash Unit .....	43
Multiple Exposures .....	45
Using the Self-Timer .....	46
Removing the Bottom and Back Covers .....	47
Accessories for the F-1 .....	49—57
Motor Drive System and Power System .....	50
Viewfinder System .....	52
Flash Photography System .....	54
Close-up, Macrophotography and Photomicrography .....	55
Filters .....	56
Other Accessories .....	57
Proper Care of the Camera .....	59



## Technical Data

- Type: 35mm single-lens reflex camera with focal plane shutter. Picture size: 24 x 36mm.
- Interchangeable Lenses: Canon FD series lenses with aperture signal lever. FL and R series of lenses are also compatible.
- Standard Lens: Canon FD 55mm f/1.2 S.S.C., FD 50mm f/1.4 S.S.C., or FD 50mm f/1.8 S.C.
- Viewfinder: Removable pentagonal prism viewfinder. Interchangeable with Servo EE Finder, Booster T Finder, Speed Finder, Waist-Level Finder.
- Viewfinder Attachments: Angle Finders A2 and B, Magnifier R, Dioptic Adjustment Lenses, Eyecup R, Rubber Eyepiece Ring.
- Focusing Screen: Fresnel lens, standard focusing glass with split-image/microprism range-finder and eight other interchangeable types. With metering beam-splitting condenser.
- Field-of-View: 97% of actual picture area. 0.77X magnification with standard 50mm lens at infinity.
- Finder Information: Meter needle and aperture needle, outside shutter speed coupling range indicator, stopped-down metering and battery check, shutter speed scale, metering limit marks.
- Dioptic Adjustment Lenses: Viewfinder with lensless ring (R-1); interchangeable with R+3, R+2, R+1.5, R+1, R+0.5, R0, R-0.5, R-2, R-3, and R-4 dioptic adjustment lenses.
- Mirror: Quick return mirror with shock-absorbing mechanism. Possible to lock mirror in up-position, requiring manual operation of the aperture.
- Lens Mount: Canon breech-lock FD mount.
- Function: FD lenses; Full aperture metering, automatic diaphragm operation. FL lenses; Stopped-down metering, automatic diaphragm operation. R lenses; Stopped-down metering, manually operated diaphragm.
- Shutter: Focal plane shutter using a super thin titanium screen. Designed for elimination of functioning noise. Possible to lock shutter release button.
- Shutter Speed Dial: With shutter scales and ASA film speed scales. Two coupling pins for setting attachments are provided.
- Shutter Speeds: B, 1-1/2000. Multiple series. Equiinterval index. X contact at "60".
- Film Speed Scale: ASA 25-3200
- Self-Timer: Built-in. Activate with shutter release button. Approx. 10 sec. time lag.
- Exposure Adjusting Mechanism: Built-in. Using a CdS photocell. Coupled to shutter speeds,

film speeds and f/stop. Match needle type, TTL full aperture metering mechanism. Central area metering system, measures 12% of the picture area. Stopped-down metering possible with non-FD lenses. Stopped-down lever and index. Locking of the lever possible.

■ Exposure Meter Coupling Range: With ASA 100 film, EV 2.5 (f/1.2 at 1/4 sec.) to EV 18 (f/11 at 1/2000 sec.).

■ Meter Battery: One 1.35V mercury battery.

■ Battery Checker: Built-in.

■ TTL Full Aperture Metering System EE: Servo EE Finder and Battery Case in combination. Full aperture metering with FD lens.

■ Ultra-low Illumination Metering: Metering possible with ASA 100, between EV 15 (f/22 at 1/60 sec.) and EV -3.5 (f/1.2 at 15 sec.), with use of the Booster T Finder.

■ Synchronized Flash: FP and X contact. Automatic time lag adjustment.

■ Flash Socket: Screw/insertion type.

■ Accessory Shoe: Flash Couplers D, L.

■ Canon Auto Tuning (CAT) System: Diaphragm control by recharge completion signal and focusing distance signal. Proper aperture is determined with the built-in mirror by using the Speed-lite 133D, Flash-Auto Ring A<sub>2</sub>/B<sub>2</sub>, Flash Coupler L and the prescribed FD lens.

■ Synchronizing Range: FP class: 1/2000-1/125 sec. and 1/30 sec. or slower. Speedlite: 1/60 sec. or slower. M, MF class: 1/30 sec. or slower.

■ Film Loading: With multislit film spool.

■ Film Winding: Short-stroke winding possible. Single operation 139° winding lever. Play: 30°

■ Film Rewinding: Performed by rewind button and crank.

■ Multiple Exposure: Possible by operating film rewind button.

■ Back Cover: Removable for Film Chamber 250 and Data Back.

■ Bottom Cover: Removable for Motor Drive Unit or Motor Drive MF.

■ Frame Counter: Additive, self-resetting type activated by opening back cover.

■ Size: 99.5 x 146.7 x 49.5mm (3-15/16" x 5-3/4" x 1-15/16")

■ Weight: Body: 845g (1 lb. 13-13/16 ozs.). With FD 50mm f/1.4S.S.C. Lens: 1,150g (2 lbs. 8-9/16 ozs.).

Subject to change without notice.



# Follow these simple steps for Normal photography:

- 1** Load the film. (See pages 15–17.)
- 2** Set the ASA film speed. (See page 25.)
- 3** Wind the film advance lever. (See page 18.)
- 4** Remove the lens cap.

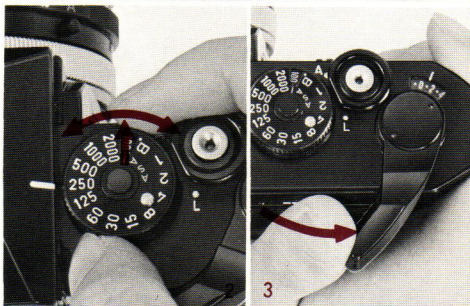
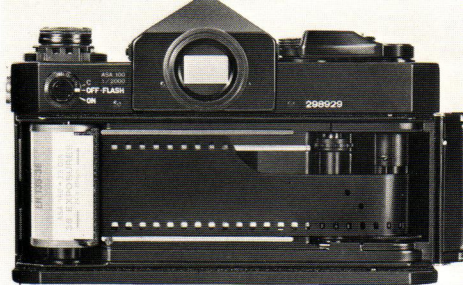





**5** Look through the viewfinder and focus.  
(See page 31.)

**6** Compose the picture.

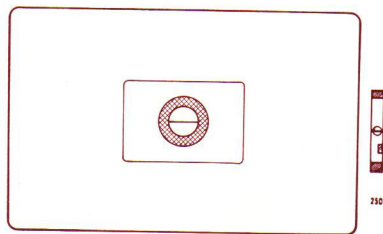

**7** Determine the exposure with built-in meter.  
(See pages 26–28.)



**8** Press the shutter release button gently.

## Mercury Battery Loading and Checking

The built-in exposure meter of the Canon F-1 functions only when the mercury battery is properly loaded.

- 1** Insert a coin into the groove of the battery compartment cover and turn it to the left to remove the cover.
- 2** Insert the battery into the compartment with negative pole first.
- 3** Replace the compartment cover and turn to the right to tighten.

- Before inserting the battery, wipe off fingerprints or stains on the battery poles with a dry cloth. Unclean poles may cause corrosion and damage the camera.
- A 1.35V H-D mercury battery should be used — a Mallory PX-625 or Eveready EPX-625 is recommended. Do not use 1.4V mercury batteries.
- Be sure to insert the battery in the correct direction. Otherwise, the meter will not function properly and the cover cannot be screwed-in.
- If the camera will not be used for an extended length of time, the battery should be taken out of the battery compartment to prevent possible damage to the terminals from battery corrosion.

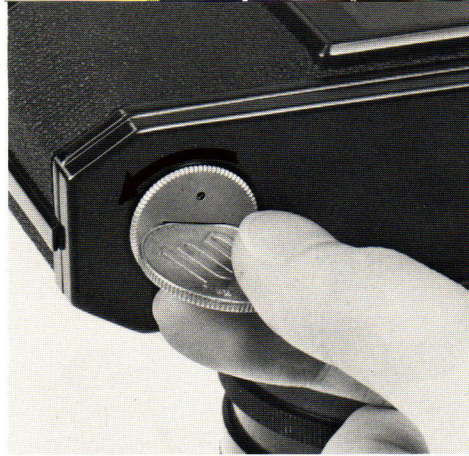

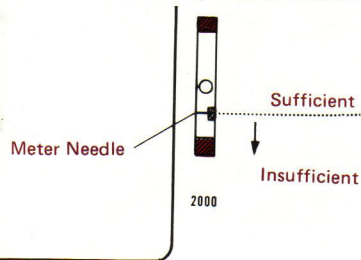
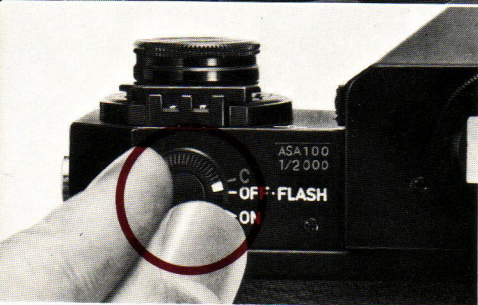
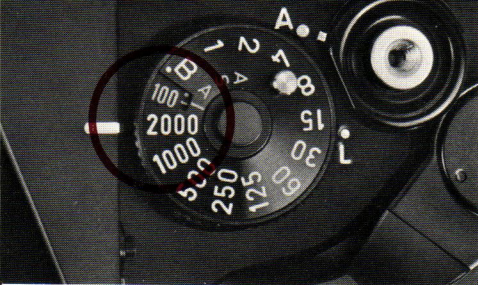

## Battery Check

Check the mercury battery after loading it. Especially when loading a new battery, be sure to check the power level.

**1** Set the film speed scale at ASA 100 and the shutter speed dial at "2000". To set the film speed, lift up the outer ring on the shutter speed dial and turn. (See page 25.)

■ A positive check cannot be made if other settings are used.

**2** Turn the meter switch, situated on the back side of the camera near the film rewind crank, to the "C" index mark.

**3** If the meter needle inside the viewfinder swings into the meter index, the battery has sufficient power. If the needle stays below the meter index, the voltage is insufficient and the battery must be replaced.

■ Life of the battery in normal use is approximately one year.

**4** When using the camera, be sure to turn the meter switch to "ON".



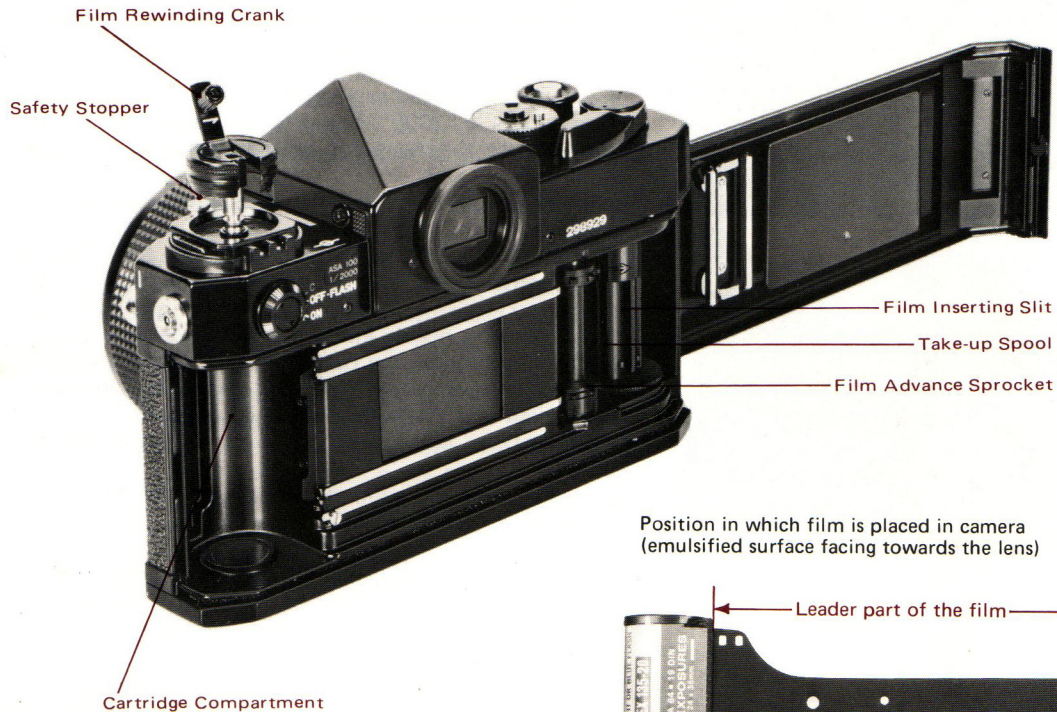

Position in which film is placed in camera  
(emulsified surface facing towards the lens)

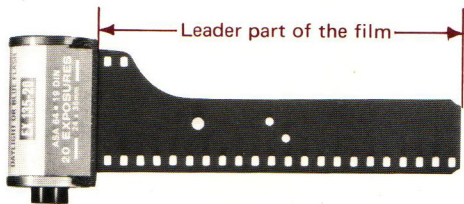

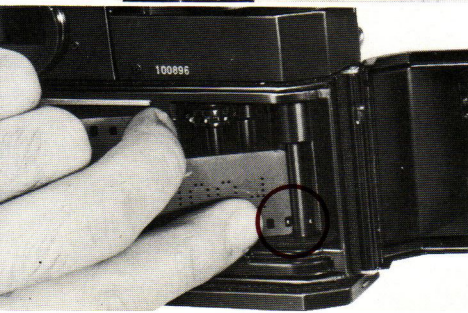
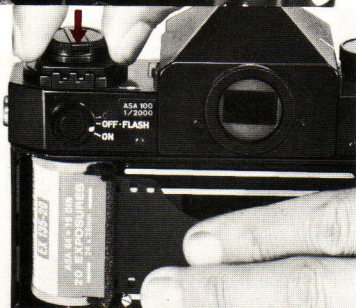
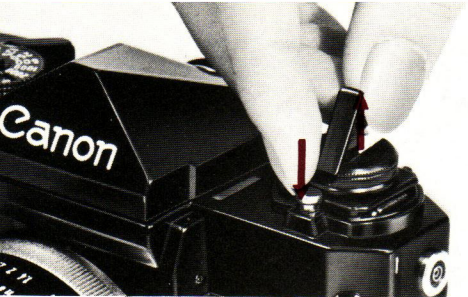

## Film Loading

The Canon F-1 accepts any standard 35mm film in a daylight loading cartridge. Be sure not to load film in direct sunlight.

- 1** Pull up the film rewind crank as far as possible while pressing the safety button. The cover will then open.
- 2** Open the cover fully. Place the film cartridge in the film compartment so that the emulsion faces the lens when the film is unspooled as illustrated on page 14. Push the film rewind crank down. The crank fork will slip into the film cartridge. In case the crank does not fully return, turn it slightly to the left or right.
- 3** Pull the film out from the cartridge and insert the film tip into the slit of the film take-up spool.

- 4** Turn the film advance lever and wind the film around the film take-up spool.
- 5** Check to insure that the teeth of both the take-up spool and the film advance sprocket engage the perforations in the film.
- 6** Close the back cover. If the film is slack, the cartridge will rise and the back cover will not close.
- 7** Leave the lens cap on and take two blank shots, each time turning the film advance lever and releasing the shutter. The frame counter will advance from the "S" mark to "0". With one more advance, the camera will be ready for the first shot.

### Memo Holder

The memo holder on the camera's back cover is useful for keeping data like film speed, location, shooting. For example, after tearing off the end of the film box which specifies the type of the film being used, it can be inserted into the memo holder as a constant reminder.

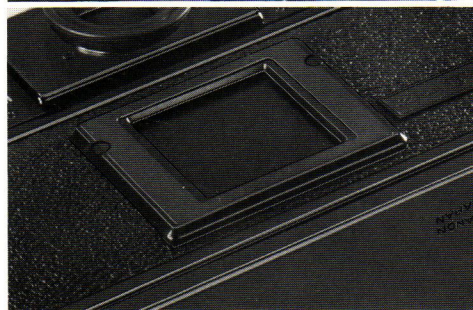
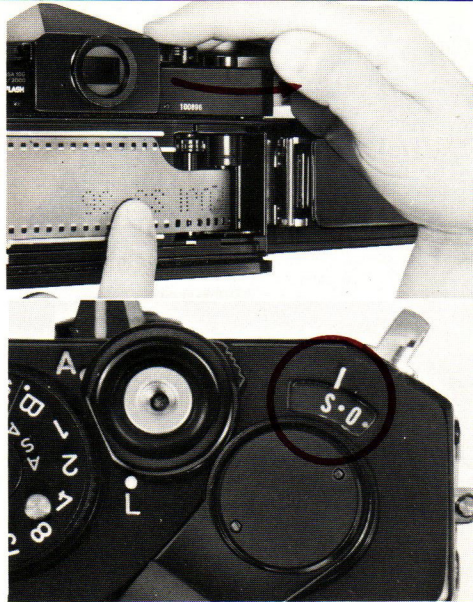



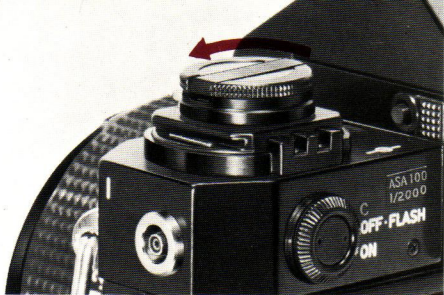

## Checking Correct Film Loading

The film is properly loaded and advanced if the film rewind crank rotates when you wind the film advance lever. If the film rewind crank does not rotate, take out the film and reload it.

## Setting the Film Speed

When loading the film, be sure to set the film speed scale at the proper position.

## Repacking a Bulk-Loaded Film

If you are using film that has not been wound commercially, be sure to trim the tip of the lead between perforations.

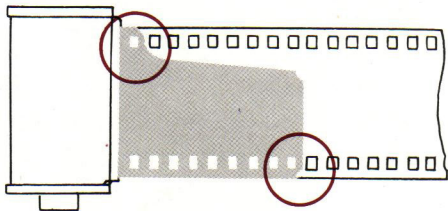
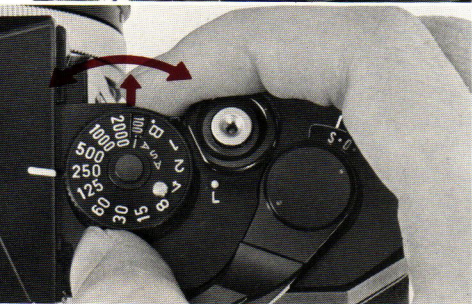

## Film Winding

The film advance lever winds the film, cocks the shutter, and prepares the diaphragm and mirror for the next shutter release all in one motion.

**1** Turn the film advance lever until it stops. The film will be advanced one frame and the shutter cocked. The frame counter is simultaneously advanced to the next number.

**2** When the shutter release button is pressed, the mirror flips up, the diaphragm closes down to the preset f/stop and the shutter operates. The advance lever can then be wound for the next frame.

- Be sure to set the shutter lock lever at "A".
- Winding may be accomplished by moving the lever with several short strokes.
- If the shutter does not function, check to make sure the winding process is completed as the shutter will not function unless winding is completed.

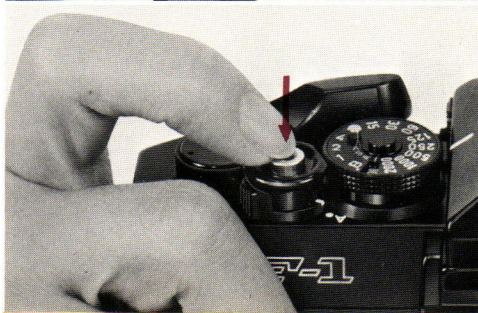
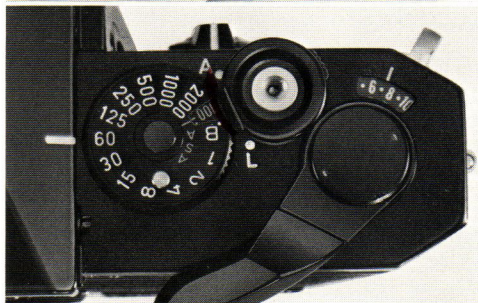

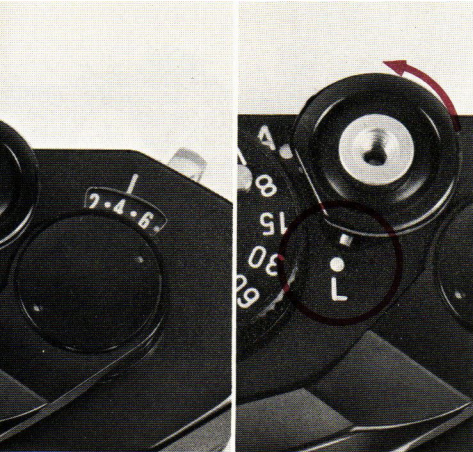

### Frame Counter

Each winding will advance the number of the frame counter, indicating the number of pictures taken. When the back cover is opened, the counter automatically returns to the starting position "S".

### Safety Device for Shutter

When the shutter lock lever around the shutter release button is turned to the "L" position, the shutter button is locked and will not move. This device is especially useful in preventing an accidental shutter release of a wound camera.

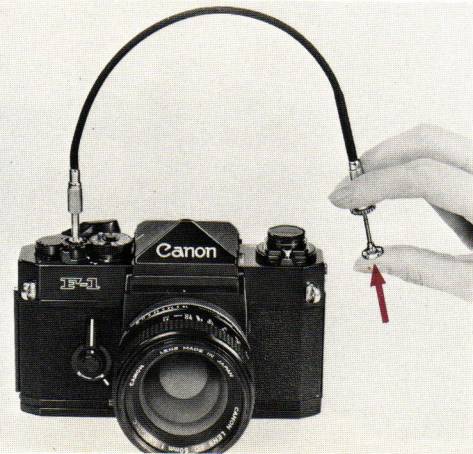

### Attaching the Cable Release

The optional Canon Cable Release can be attached to the F-1 by screwing it into the threaded hole in the center of the shutter release button. Even if the shutter lock lever is at the "L" position, the shutter will operate when using the cable release.



## Shutter and Aperture Adjustment

Exposure is adjusted by the shutter speed and the aperture. The shutter speed controls the exposure time and the aperture controls the amount of incoming light.

### Shutter Speed Dial

Adjust the shutter speed by turning the shutter speed dial to the desired speed as indicated by the numbers on top of the dial. The dial cannot be turned between "2000" and "B". The numbers on the shutter speed dial correspond to shutter speeds between 1/2000 of a second and one second counting counterclockwise on the dial. The "B" position, indicating bulb exposure, is used when making exposures of more than one second. Thus, when set at "B", the shutter remains open as long as the shutter release button is depressed.

- Be sure to set the dial at one of the click-stop positions. At the "B" position, adjust it to the white dot just below "B".

- When it is necessary to make a time exposure, first set the shutter speed dial at "B". Keep the shutter release button depressed and turn the time lock lever to "L". Thus, the shutter will remain open even if the finger is removed from the button. When the lever is returned to "A", the shutter closes.

- Time exposure is also possible by using a lockable cable release.

- It is possible to perform extended exposures of up to

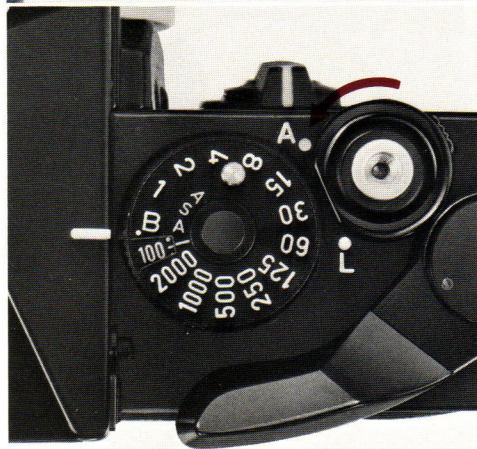
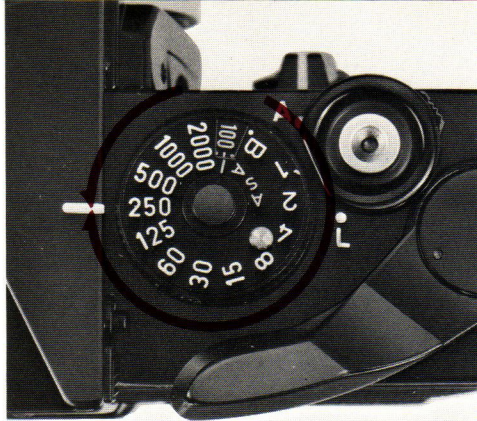



30 seconds by using the optional Booster T Finder, a super sensitive meter finder for measuring subjects under dim light.

■ The "60" position is the X synchronization speed, the highest shutter speed which can be used with electronic flash units such as a Canon Speedlite, and the fastest shutter speed at which the entire film area is exposed at once. Although 1/60th of a second does not seem to be a really fast shutter speed, the effective exposure time is equivalent to a flash of 1/1000th of a second or faster. This speed allows the very brief duration of the electronic flash to expose the entire film.

## Aperture

Incoming light and depth-of-field are adjusted by turning the aperture ring to the desired f/stop.

A number scale, which has become the international standard, has been devised to express the size of the aperture in relation to the focal length of the lens whereby the aperture size is divided by the focal length of the lens until the numerator of the resulting fraction is reduced to one. Thus, the magnitude of these fractions is inversely related to the size of the aperture, i.e., a larger number on the scale signifies a smaller aperture while a smaller number signifies a larger aperture. Since both circular area and linear dimension are involved in the computation of this scale, an aperture, usually termed a full f/stop, is one-half or twice as large as the adjacent apertures indicated by the scale.



- The aperture ring of most Canon FD lenses is equipped with click-stops for full and 1/2 f/stops, but can be set between these click-stops.
- The maximum aperture of a lens may not be one included by the international standard. If it is not, the second f/stop will not designate an aperture one-half as small as the maximum f/stop.
- The relation between the aperture and the amount of light entering, using f/2 as the base, is as follows:

f/stops\*:

1.2 1.4 1.8 2 2.8 3.5 4 5.6 8 11 16 22

Exposure Ratio:

3 2 1.25 1 1/2 1/3 1/4 1/8 1/16 1/32 1/64 1/128

\*f/stops on the international scale are in heavy type.

## Presetting of Aperture

Set the aperture ring to the desired f/stop. The diaphragm will close to the set f/stop only for the instant that the shutter is released. Thus, for example, with FD lenses, the subject can always be seen through the viewfinder at the full aperture opening even after the f/stop has been set by the aperture ring.

The FD lens has only one aperture ring. When this lens is mounted on an F-1 or FTb camera body, the diaphragm can be operated manually by pushing the multi-purpose lever. The aperture can then be closed down to any desired f/stop by turning the aperture ring. When the lever is reset to its original position, the diaphragm returns to its maximum opening.



FD 50mm f/1.4 S.S.C.



Automatic/Manual Aperture Lever





FD 35mm f/3.5 S.C.



Manual Aperture Lock Lever  
Automatic/Manual Aperture Lever

## Manual Control of Aperture

The manually operated aperture is used for checking the depth-of-field when the aperture is stopped-down and also when performing close-up photography and macro-photography.

- When an accessory is to be used between the lens and the camera body, push the automatic/manual aperture lever of the lens counterclockwise all the way before mounting the lens. This locks the lever and the aperture is set for manual operation. For releasing the lever, push it clockwise. With the use of this lock, photography using a manually operated aperture can also be performed with older Canon single-lens-reflex cameras.

- In the case of the lens which has a manual aperture lock lever, turn the automatic aperture lever of the lens counterclockwise all the way and set the manual aperture lock lever at the "L" position before mounting the lens. This manual aperture lock lever locks the automatic aperture lever and the diaphragm can be opened or closed by turning the aperture ring. For releasing the lever, return the manual aperture lock lever to the original position at the white dot.

- When using the lens attached in a reversed position to the macrophoto coupler for macrophotography, set the automatic aperture lever of the lens in the position for manual operation, attach the macrohood of the macrophoto coupler to the rear of the lens, and turn the breechlock mount ring unit it stops.

- Refer to page 38 concerning depth-of-field.

## Using the Built-in Exposure Meter

The Canon F-1 provides the most accurate light measurement possible with its unique TTL (Through-The-Lens) system. The built-in exposure meter, which is of match needle type, is coupled to the shutter speed dial and preset aperture ring.

The CdS photocell of the exposure meter is placed in the position closest to the beam-splitting condenser lens. The central area metering system enables accurate measurement of the main subject even in back lighting conditions. The rectangular frame in the viewfinder represents the light measurement area of the CdS photocell. Place the main subject within this frame and measure the intensity of light so as to obtain the proper exposure.

- The correction of the full aperture opening of the lens is performed automatically. Therefore, the operation does not change regardless of the speed of the lens used. An FL lens can be used only with stopped-down metering.
- Due to the characteristics of the CdS photocell, the movement of the meter needle may occasionally be slow at low light intensities.
- When not using the camera, set the meter switch at "OFF" or attach the lens cap so as to prevent unnecessary consumption of the mercury battery.
- Metering at "B" on the shutter speed dial is not possible with the built-in exposure meter.

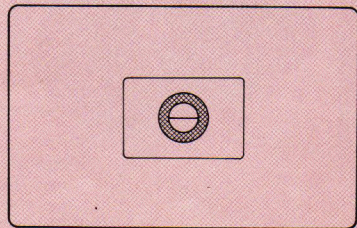
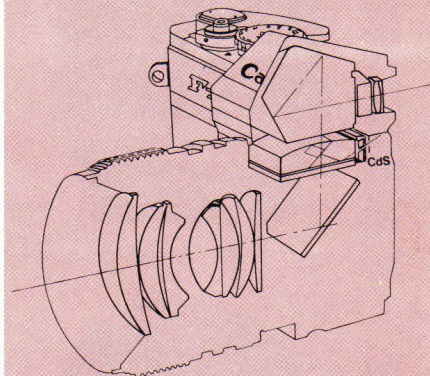



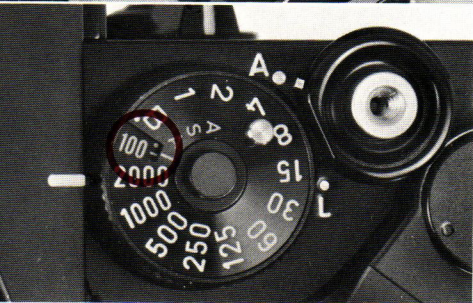
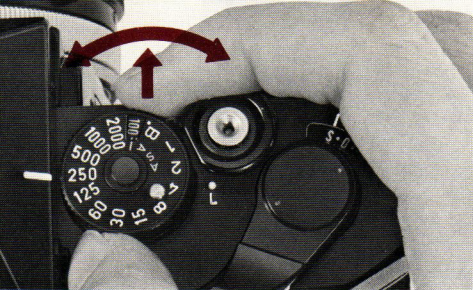

## Film Speed Setting

Set the film speed according to the ASA of the film being used. The ASA of a film is normally shown on the film box cover or explanatory sheet. Lift and turn the film speed ring which is around the shutter speed dial. The ASA number of the film will appear in the window on the shutter speed dial.

The ring cannot turn any further counterclockwise than "25". On the other hand, it cannot turn any further clockwise than "3200."

- The following film speeds may be used:

	(32)	(40)	(64)	(80)	(125)	(160)	(250)	(320)	(500)	(640)
ASA	25	· · 50	· · 100	· · 200	· · 400	· · 800				
DIN	15	· · 18	· · 21	· · 24	· · 27	· · 30				
	(16)	(17)	(19)	(20)	(22)	(23)	(25)	(26)	(28)	(29)
	(1000)	(1250)	(2000)	(2500)						
	· · 1600	· · 3200								
	· · 33	· · 36								
	(31)	(32)	(34)	(35)						

(Figures in parentheses represent intermediate film speeds.)



# Exposure Settings

## Full Aperture Metering

Full aperture metering can be performed with FD lenses which have an aperture signal lever and pin.

- 1 Set the meter switch at "ON".
- 2 Set the shutter speed dial at the desired speed.
- 3 Face the camera towards the subject, look into the viewfinder, and check the needles in the meter reading window.
- 4 Turn the aperture ring until the meter needle bisects the aperture metering circle in the meter. If this adjustment cannot be made, a different shutter speed must be used.

- The meter needle is coupled to the film and shutter speeds and moves vertically according to the brightness of the subject. The meter needle moves downward when the shutter is set at high speeds and upward when it is set at low speeds. When the shutter is set at a slow speed outside the coupling range (slower than 1/2 sec. with ASA 100 film), the meter window turns red, and metering will become impossible even if the aperture is changed. When the window turns red and metering cannot be performed, use high-speed film or the optional Booster T Finder. Refer to "Coupling Range of Built-in Exposure Meter" on page 29.

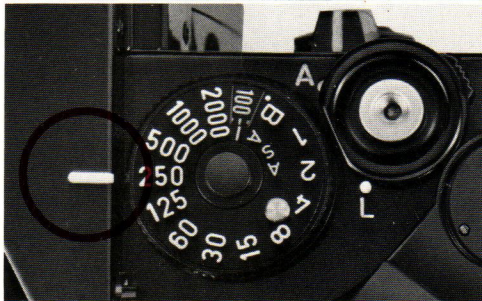
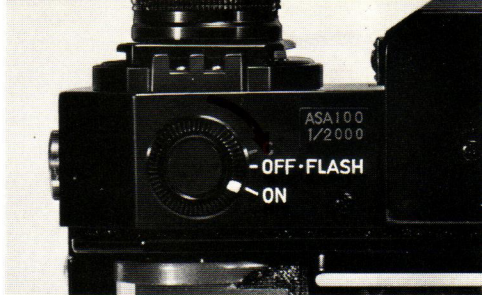

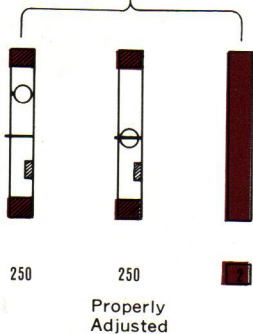
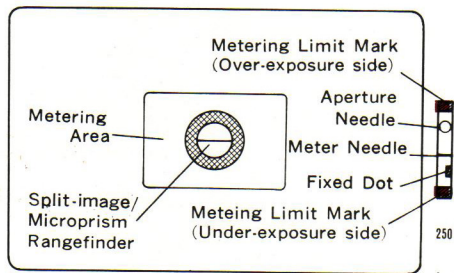

- Select a faster shutter speed when the meter needle swings all the way up, and a slower speed when it swings all the way down.
- The circular aperture needle is coupled to the aperture ring of the FD lens. The movement range of the aperture needle inside the meter reading window changes according to the lens speed. Thus, it will not always move vertically the full length of the meter reading window.
- The "A" mark on the aperture ring is used with the Servo EE Finder or the Canon AE cameras only.
- If you prefer to set the f/stop first, turn the shutter speed dial and bi-sect the aperture metering circle with the meter needle.
- Since the shutter speed dial cannot be set at intermediate positions, the shutter speed priority method is recommended when exposure accuracy is a crucial factor.

## Stopped-Down Metering

When using a lens, such as an FL-series lens, which does not have a full aperture metering system, stopped-down metering should be used. Stopped-down metering is executed by pushing the multi-purpose lever towards the lens. The lever can be fixed in this position by pressing it towards the lens after setting the lock lever at the "L" position. If the lock lever is returned to the white dot

position, the stopped-down lever will return to its original position.

- 1 Set the meter switch at "ON".
  - 2 Set the shutter speed dial at the desired speed.
  - 3 Face the camera towards the subject, look into the viewfinder and press the stopped-down lever towards the lens. The circular aperture needle will disappear from view and only the meter needle will remain in the meter window.
  - 4 Turn the aperture ring until the meter needle appears in the meter.
- If you prefer to set the f/stop first, the adjustments can be made with the shutter speed dial.
  - Because the FD lenses have a full aperture system with which to fully compensate the built-in exposure meter, it is best to use full aperture metering with an FD lens. When performing stopped-down metering, be sure to close down the aperture to f/2.8 or further.

## How to "Average" Exposures

When measuring a subject influenced by greatly different light intensities, take two measurements, one each of the darkest and lightest parts, and obtain the average value for the two readings. Then, set the f/stop or shutter speed at this average value.

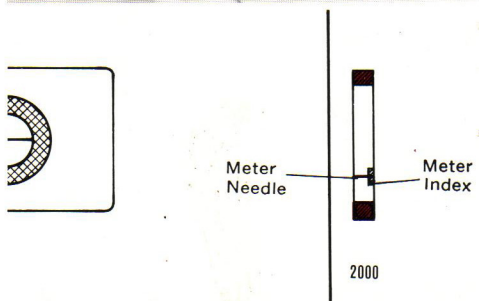
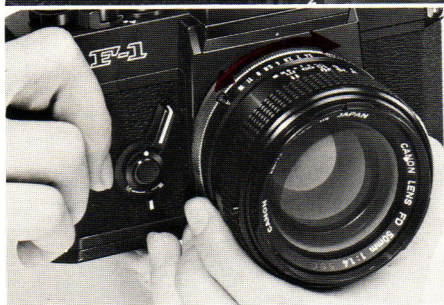
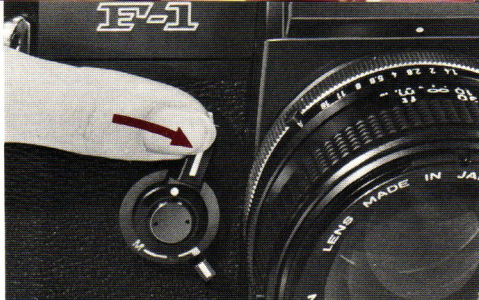



## Coupling Range of Built-in Exposure Meter

At given film speeds, the built-in exposure meter couples within the f/stops and shutter speeds as indicated in the chart at the right. For example, when using the Canon FD 50mm f/1.4 S.S.C. lens at ASA 100, the exposure meter couples fully within the range of EV 3, f/1.4 at 1/4 of a sec. (the first number as read off the row labeled "ASA 100") to EV 18, f/11 (read off the bottom row) at 1/2000 of a sec. (again read off the "ASA 100" row, but this time read the last number). Thusly the first number of a row indicates the longest shutter speed possible at a given film speed with the aperture fully open while the last number denotes the fastest shutter speed possible with the f/stop used being read from the bottom row as the number directly under the fastest shutter speed.

Film Speed	Shutter Speed											
	1	$\frac{1}{2}$	$\frac{1}{4}$	$\frac{1}{8}$	$\frac{1}{15}$	$\frac{1}{30}$	$\frac{1}{60}$	$\frac{1}{125}$	$\frac{1}{250}$	$\frac{1}{500}$	$\frac{1}{1000}$	$\frac{1}{2000}$
ASA 25	1	$\frac{1}{2}$	$\frac{1}{4}$	$\frac{1}{8}$	$\frac{1}{15}$	$\frac{1}{30}$	$\frac{1}{60}$	$\frac{1}{125}$	$\frac{1}{250}$	$\frac{1}{500}$	$\frac{1}{1000}$	$\frac{1}{2000}$
ASA 50	$\frac{1}{2}$	$\frac{1}{4}$	$\frac{1}{8}$	$\frac{1}{15}$	$\frac{1}{30}$	$\frac{1}{60}$	$\frac{1}{125}$	$\frac{1}{250}$	$\frac{1}{500}$	$\frac{1}{1000}$	$\frac{1}{2000}$	...
ASA 100	$\frac{1}{4}$	$\frac{1}{8}$	$\frac{1}{15}$	$\frac{1}{30}$	$\frac{1}{60}$	$\frac{1}{125}$	$\frac{1}{250}$	$\frac{1}{500}$	$\frac{1}{1000}$	$\frac{1}{2000}$	...	...
ASA 200	$\frac{1}{8}$	$\frac{1}{15}$	$\frac{1}{30}$	$\frac{1}{60}$	$\frac{1}{125}$	$\frac{1}{250}$	$\frac{1}{500}$	$\frac{1}{1000}$	$\frac{1}{2000}$	...	...	...
ASA 400	$\frac{1}{15}$	$\frac{1}{30}$	$\frac{1}{60}$	$\frac{1}{125}$	$\frac{1}{250}$	$\frac{1}{500}$	$\frac{1}{1000}$	$\frac{1}{2000}$	...	...	...	...
ASA 800	$\frac{1}{30}$	$\frac{1}{60}$	$\frac{1}{125}$	$\frac{1}{250}$	$\frac{1}{500}$	$\frac{1}{1000}$	$\frac{1}{2000}$	...	...	...	...	...
ASA 1600	$\frac{1}{60}$	$\frac{1}{125}$	$\frac{1}{250}$	$\frac{1}{500}$	$\frac{1}{1000}$	$\frac{1}{2000}$	...	...	...	...	...	...
ASA 3200	$\frac{1}{125}$	$\frac{1}{250}$	$\frac{1}{500}$	$\frac{1}{1000}$	$\frac{1}{2000}$	...	...	...	...	...	...	...
Minimum f/stop	f/22	f/22	f/22	f/22	f/22	f/22	f/22	f/22	f/16	f/11	f/8	f/5.6

## Holding the Camera

Hold the camera firmly to take a clear picture. Hold the camera either in a vertical or horizontal position, look through the viewfinder, and focus. Then press the shutter release button gently. The following techniques are important to remember:

- 1 Hold the camera snugly in both hands. The camera should be pressed firmly to your cheek or forehead.
- 2 When the camera is in a horizontal position, both elbows should be firmly pressed against the body. At least one elbow should be resting against the body when the camera is in a vertical position.
- 3 Hold your breath and press the shutter release button with a smooth, steady stroke. Otherwise, you will have a blurred picture.
- 4 It is best to use a tripod and cable release when using slow shutter speeds.
- 5 When taking pictures against the light, always use a lens hood.

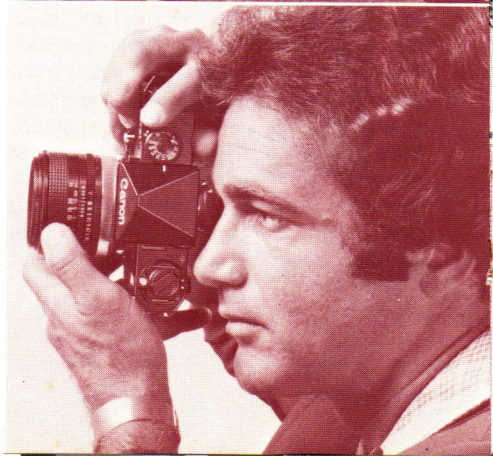



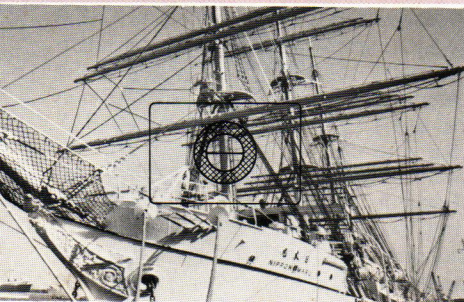
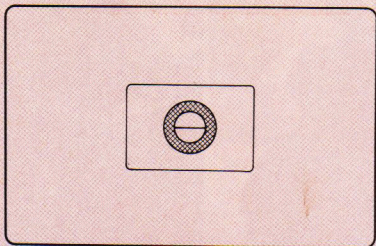

## Viewing and Focusing

Focusing is performed in the small round area in the center of the viewfinder. The smaller central circle is a split-image focusing screen and around it is the microprism ring. The split-image rangefinder ascertains that the image is "in focus" when the image divided horizontally in half matches and becomes one complete image.

The microprism rangefinder presents a clear and steady image when in focus. The microprism conveys a broken, shimmering image when not accurately in focus. It is also possible to focus with the matte screen outside the smaller central area. You can focus with either of these focusing aids as you like, depending on the subject condition and your preference.

- A curved line may sometimes be visible in the lower part of the viewfinder according to the angle of the incoming light. This is a reflection of the beam-splitting mirror of the condenser lens in the TTL light measurement system.

### Viewfinders

The Eye-Level Finder can be removed and interchanged with other viewfinders. To remove the Finder, pull it towards the backside of the camera while pressing the two stopper buttons on both sides of the Finder. To attach a finder, slide it in from the rear of the camera so that the attachment rails of the viewfinder are level with the camera body. Push it all the way in. It will

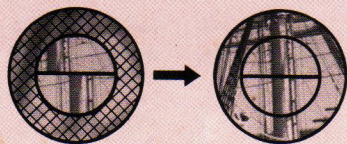

Out of Focus

In Focus



lock in place with an audible click.

Interchangeable viewfinders that can be used include: the Booster T Finder, Servo EE Finder, Speed Finder and Waist-Level Finder. (See page 52.)

### Focusing Screens

The focusing screen inside the finder box can also be interchanged. The standard focusing screen has a split-image/micropism screen rangefinder. There are eight other types of screens available. They are the micropism rangefinder, split-image, all-matte, matte/section, micropism/large aperture lenses, micropism/small aperture lenses, matte/scale and double cross-hair reticule types. (See page 53.)

The focusing screen can be lifted out by inserting a fingernail into one of the two notches on the rear edge of the focusing screen and prying upwards. Remove the focusing screen from the finder box by picking it up by its metallic edges.

To insert a focusing screen, face the protruding part of the screen toward the front of the camera and insert it under the metallic lip on the camera body side. Then, press down on the rear end of the focusing screen so that it drops into a horizontal position.

While inserting a new focusing screen, if you put the previous screen down, place it upside down to prevent the focusing screen side from being marred by foreign particles.

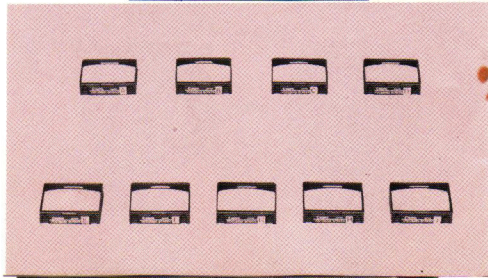
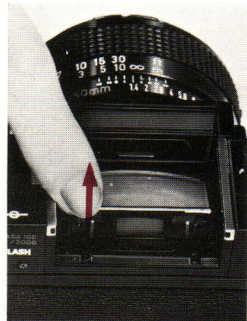
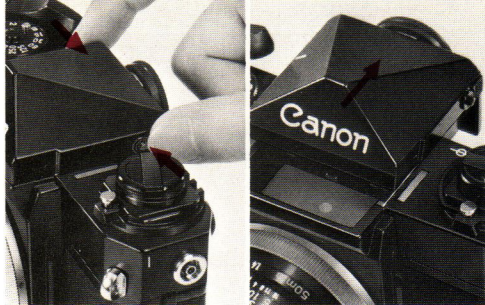

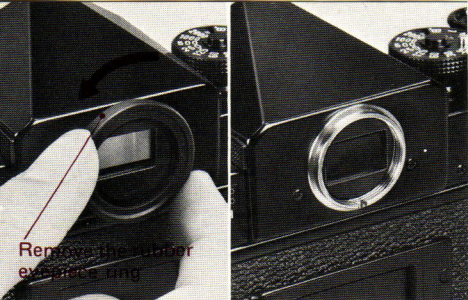

Remove the rubber eyepiece ring

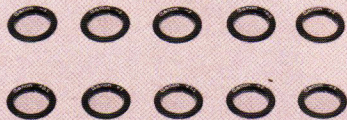

Dioptric Adjustment Lenses:

R-4, R-3, R-2, R-0.5, R0,  
R+0.5, R+1, R+1.5, R+2, R+3

## Dioptric Adjustment Lenses

The screw-in type dioptric adjustment lenses are interchangeable. A glassless ring is attached to the viewfinder which has a power of  $-1.2$  diopters, while ten other kinds of dioptric lenses are available as optional attachments. The diopters of these lenses are adjusted solely for use with the F-1. Thus, the diopters of the lenses are not "true" to their markings when the lenses are used by themselves, but are "true" to their marking when the lenses are taken in conjunction with the camera.

- Dioptric adjustment lenses can also be used when a Magnifier R is attached to the viewfinder eyepiece.
- Dioptric adjustment lenses should be removed when the Angle Finders A2 and B are attached, which are adjustable.

## Angle Finder A2 and B

Canon angle Finders A2 and B can be attached to the eyepiece for copying, macrophotography, and photomicrography.

## Magnifier R

The optional Canon Magnifier R can be attached to the viewfinder eyepiece of the F-1 which magnifies the rangefinder section for accurate focusing. Because it can be flipped up and locked, the entire field-of-view can be easily viewed after focusing.

## Eye Cup R

After taking off the standard Rubber Eyepiece Ring, the Eye Cup R can be attached to the dioptric adjustment ring.

- When attaching the Angle Finder or Magnifier, take off the Rubber Eyepiece Ring.

Angle Finder B



Magnifier R



Eyecup R





## Film Rewinding

When the film reaches the end and the film advance lever stops, rewind the film into the cartridge as soon as possible. If you force the film advance lever after the film reaches its end, the film may become detached from the cartridge spool or tear, making rewinding impossible. Be sure not to open the back cover before rewinding. Otherwise, the entire roll will be exposed and ruined as the exposed film is uncovered within the camera.

**1** Press the film rewind button found on the bottom of the camera. Once the film rewind button has been pressed, your finger may be removed from it.

**2** Raise the film rewind crank, turn it clockwise as indicated in the photo at right by the arrow and rewind the film into the cartridge. When the film rewind button stops revolving and rewinding resistance becomes light, stop rewinding. The finish of the film rewinding will be noticed by the cessation of rewinding noise.

**3** Open the back cover.

**4** Pull up the rewind knob fully and remove the cartridge.

- The film rewind button will pop out automatically when the back cover is opened.

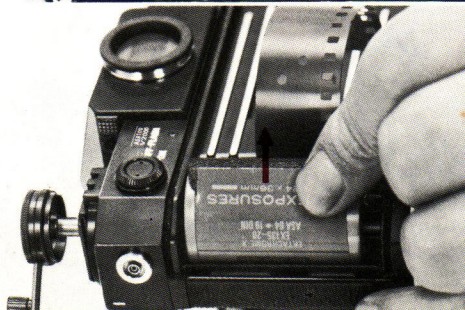





## Uses of Lenses

### Changing Lenses

- 1** Be sure to unlock the stopped-down lever. If the lever is pressed or is locked, a red dot appears inside the camera mount. The automatic/manual aperture lever, at the back end of the lens, cannot be connected to the coupling on the camera body and the aperture will not function.
- 2** Remove the dust cap of the lens by turning the breech-lock mount ring clockwise.
- 3** Align the red dot on the breech-lock mount ring with the red dot on the camera body directly under the Pentaprism. Engage the lens with the camera and turn the Breech-Lock Mount Ring clockwise to lock the lens in place.
- 4** To remove the lens from the camera body, turn the Breech-Lock Mount Ring counterclockwise until the two red dots are re-aligned, then disengage the lens from the body.

## Lens Signal Coupling

### Aperture Signal Lever:

The Aperture Signal Lever transmits the f/stop of the automatic aperture to the camera body. It is on a one-to-one movement basis with the aperture through lever manipulation. When the aperture ring is set at the "A" mark for EE photography, the aperture signal lever is disconnected from the aperture ring. The aperture opening can then be set automatically by the Servo EE Finder. The aperture signal lever has a safety device so that the lever is set to the starting position when the breechlock mount ring is turned to the attached position.

### Full Aperture Signal Pin

The Full Aperture Signal Pin relays the lens's maximum aperture to the meter. This compensates for the meter deviation of the open aperture metering.

### Automatic/Manual Aperture Lever

The Automatic/Manual Aperture Lever functions to stop-down the aperture to the preset position. Clamp it to the right side fully for manual operation of the aperture.

### EE Lock Pin

The EE Lock Pin is a protective pin used to prevent the aperture of the lens from moving to the "A" mark accidentally. To set the aperture of the lens at the "A" mark, turn the aperture ring while pushing down the EE lock pin. To disengage from the "A" mark, turn the

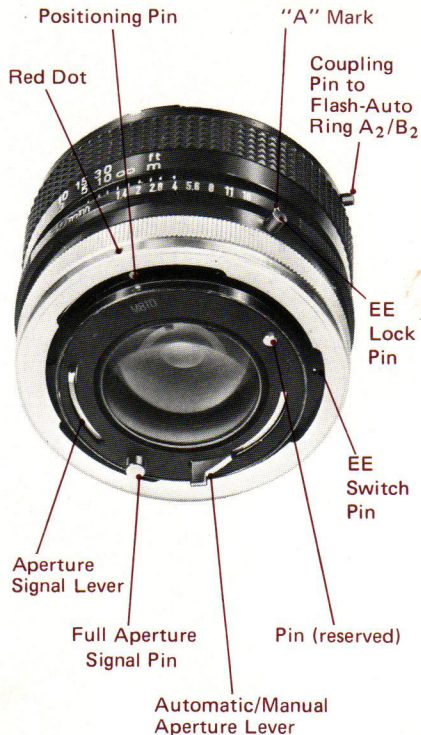



Distance Scale

Infrared Index

Index (orange line)

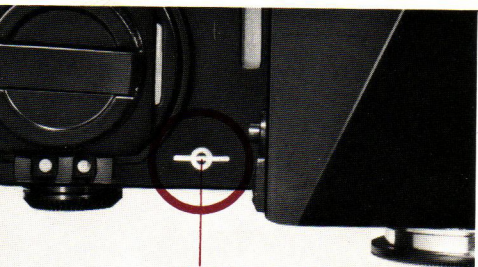

Film Plane Indicator

aperture ring, again pushing down the EE Lock Pin.

### EE Switch Pin

When the aperture ring is set at the "A" mark for EE photography, the lens can be attached only to the F-1 or AE cameras. If the lens is be attached to cameras other than these, it cannot be set at the "A" mark.

### Distance Scale

The distance scale indicates the distance between the focused subject and the film plane. The scale is necessary for checking the depth-of-field, for flash and for infrared photography. The exact reading from the distance scale is at the center of each number.

### Infrared Mark "."

The infrared mark "." is used to make the necessary adjustments to the camera for infrared photography. The correction of the distance scale is required in infrared photography because the focal point diviates slightly from the one in ordinary photography. Focus first in the ordinary manner, then adjust the distance scale to the "." mark imprinted in red. For instance, if the distance scale reads 10m after focusing, merely shift the 10m mark to the "." mark. The position of the "." mark on the F-1 is based on using film with a maximum sensitivity of 800nm such as a Kodak IR 135 film and a Wratten 87 filter.

### Film Plane Indicator

The film plane indicator is used in the case when focusing is done by actual measurement. Measure the distance from the film plane indicator and set the measured distance on the distance scale.



## Depth-of-Field Scale

The depth-of-field scale indicates the distances from the camera in which the photograph's subjects will be in sharp focus on the film. For example, if the lens used is a 50mm lens and the subject has been focused at a distance of 3m (10'), with an  $f/8$  value, read off from the scale on either side of the indicator (orange line). The depth-of-field is from approximately 2.3m (8') to 4.3m (14'). If the aperture is closed down to  $f/16$ , the picture will become sharp between 1.9m (6') to 7.6m (25') from the camera. Basically, the smaller the  $f$ /stop, the greater the distance of the subject from the camera; or, the shorter the lens focal length, the deeper will be the depth-of-field. On the other hand, the larger the  $f$ /stop, the nearer the subject to the camera; or, the longer the lens focal length, the shallower will be the depth-of-field. In the case of Canon FD lenses, you can see the actual sharpness through the viewfinder by pressing the stopped-down lever.

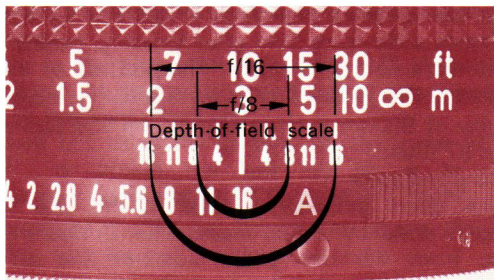

**50mm Lens  $f/8$**

Depth-of-field 2.3-4.3m (8'-14')  
Focused at 3m (10')



**50mm Lens  $f/16$**

Depth-of-field 1.9m-7.6m (6'-25')  
Focused at 3m (10')



### **FD Lens Mount (FL and R Series Lenses)**

All Canon FD and FL lenses can be used with the Canon F-1, except the FLP 38mm f/2.8.

It is also possible to attach and use all the R lenses for the Canonflex. However, as the preset aperture mechanism differs, it is necessary to use manual diaphragm control.









## Interchangeable Lenses FD/FL

The Canon F-1 is a highly versatile camera system with a wide range of interchangeable lenses from 7.5mm to 1200mm. These, together with the 180 available accessories, including the Motor Drive Unit, Motor Drive MF, Servo EE Finder, Booster T Finder and Film Chamber 250, make possible all kinds of photography. Select the interchangeable lenses and accessories that meet your needs.

1. Fish-eye 7.5mm f/5.6 S.S.C.
2. Fish-eye FD 15mm f/2.8 S.S.C.
3. FD 17mm f/4 S.S.C.
4. FD 20mm f/2.8 S.S.C.
5. FD 24mm f/1.4 S.S.C. ASPHERICAL
6. FD 24mm f/2.8 S.S.C.
7. FD 28mm f/2 S.S.C.
8. FD 28mm f/2.8 S.C.
9. FD 35mm f/2 S.S.C.
10. TS 35mm f/2.8 S.S.C.
11. FD 35mm f/3.5 S.C.
12. FD 50mm f/1.4 S.S.C.
13. FD 50mm f/1.8 S.C.
14. FD 50mm f/3.5 S.S.C. (Macro)
15. FD 55mm f/1.2 S.S.C.
16. FD 55mm f/1.2 S.S.C. ASPHERICAL
17. FD 85mm f/1.2 S.S.C. ASPHERICAL
18. FD 85mm f/1.8 S.S.C.
19. FD 100mm f/2.8 S.S.C.
20. FD 100mm f/4 S.C. (Macro)
21. FD 135mm f/2.5 S.C.
22. FD 135mm f/3.5 S.C.
23. FD 200mm f/2.8 S.S.C.
24. FD 200mm f/4 S.S.C.
25. FD 300mm f/2.8 S.S.C. FLUORITE
26. FD 300mm f/5.6 S.C.
27. FD 400mm f/4.5 S.S.C.
28. FD 600mm f/4.5 S.S.C.
29. FD 800mm f/5.6 S.S.C.
30. FD 28-50mm f/3.5 S.S.C.
31. FD 35-70mm f/2.8-3.5 S.S.C.
32. FD 80-200mm f/4 S.S.C.
33. FD 100-200mm f/5.6 S.C.
34. FD 85-300mm f/4.5 S.S.C.
35. FL 300mm f/5.6 FLUORITE
36. FL 500mm f/5.6 FLUORITE
37. FL 400mm f/5.6
38. FL 600mm f/5.6
39. FL 800mm f/8
40. FL 1200mm f/11 S.S.C.

All Canon FL and R Lenses can be used with the F-1, except the FLP 38mm f/2.8.

## Lens Hood

When attaching the lens hood to the lens, align it with the bayonet ring on the lens and turn it clockwise. With some exceptions of standard and wide angle lenses, a lens hood can be stored in the camera case. When you do this, put the lens hood on the lens in an inverted position, align it with the bayonet ring and turn in a counterclockwise direction.



Canon Speedlite 133D



Sync.  
Contact for  
Flash Unit

Contact for  
CAT System



## Synchronizing Flash Unit

The Canon F-1 is designed so that two systems of flash photography can be used with it – the match needle type semi-automatic flash photography, using the Canon Speedlite 133D or an ordinary synchronized flash photography unit.

Type		Synchronized Shutter Speeds
Flash	FP class (#6, Press 26)	1/125 or faster 1/30 or slower
	M class (M3, #5, Press 25)	1/30 or slower
	MF class AG-1, AG-3, (M2, Flashcube)	1/30 or slower
Electronic Flash Unit	Speedlite	1/60 or slower

To connect the Speedlite 133D, slip the Flash Coupler L onto the accessory shoe while remembering to lock in place the Flash Coupler L by turning the rubber-encased bar found on its back. Slide the flash unit into the Flash Coupler L from the rear. Attach the Flash Auto Ring A<sub>2</sub> or B<sub>2</sub> to the lens, insuring that it locks in place by turning it counterclockwise so that the attachment cord is on the right side of the lens. Finally, connect the attachment cord to the base of the 133D.

- The Canon Auto Tuning (CAT) System can be



connected to the FD 50mm f/1.4 S.S.C., FD 50mm f/1.8 S.C., FD 35mm f/2 S.S.C. or FD 35mm f/3.5mm S.C. lenses which have a flash adapter coupling pin.

■ When using an ordinary flash unit, or a Speedlite other than the 133D, insert the Flash Coupler D into the accessory shoe. Attach the flash unit to it and connect the cord to the flash socket of the camera. The Flash Coupler D has a direct-couple contact to which a direct-couple type flash unit can be attached.

### Deciding the Exposure

In the case of the Canon Auto Tuning System, the power level of the Speedlite 133D is continuously transmitted to the meter circuit of the camera. Thus, the correct exposure can be decided as follows: First set the meter switch to "OFF-FLASH" and the shutter speed at "60". Set the distance so that the meter needle in the meter reading window moves. Then turn the aperture ring until the aperture meter circle is bisected by the meter needle.

In all other cases, exposure is decided by dividing the guide number of the flash unit by the focusing distance. The X synchronization speed of the Canon F-1 is 1/60 of a second.

■ A lens hood should be used when taking flash pictures.

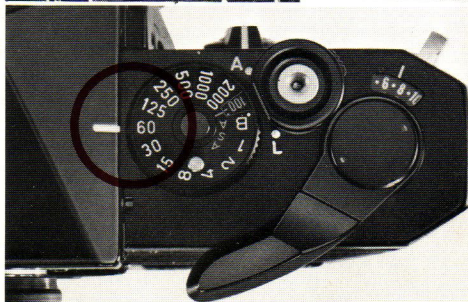
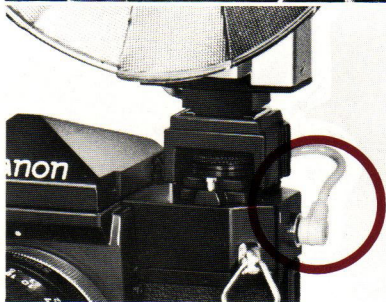
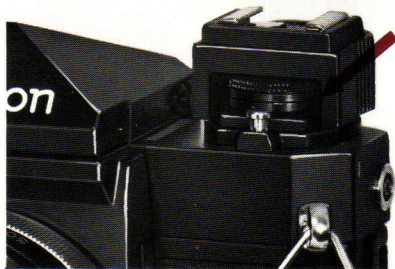



## Multiple Exposures

When more than one exposure of the same subject or different subjects are printed in the same frame, it is called multiple exposure photography. In answer to the demands for this type of mechanism, Canon designed the F-1 with this option.

- 1** Take a photo. (Before taking the first photo, turn the film rewind crank slightly to even the film's slack.)
- 2** Depress the film rewind button on the camera's body. Even if you remove your finger from the button, it will remain depressed.
- 3** Turn the film advance lever gently with single winding. Do not turn it with short-stroke winding.

If you repeatedly follow the above procedure, you can take as many pictures as you'd like with the same frame of film. In some cases, the picture frames may be slightly shifted. The exposure value of the multiple exposure can not be simply decided by the number of exposures and the brightness of subjects. There are two methods of adjustment, one by using the ASA adjustment ring, the other by adjusting the aperture manually, and both need photographer's experience. It is best to start photography with the darker subjects, and end with the lighter subject.

- When you have taken multiple exposures, each time you turn the film advance lever, the frame counter will advance by one.
- Do not use the multiple exposure when attaching a Motor Drive.

## Using the Self-Timer

- 1 Wind the film advance lever.
- 2 Turn the multi-purpose lever counterclockwise until it stops.
- 3 Depress the shutter release button. The shutter will be released approximately 10 seconds later.
  - Be sure to wind the film advance lever. Otherwise the self-timer will act but the shutter will not be released.
  - The stopped-down lever can be used in a normal manner even after the self-timer is cocked.
  - If the self-timer lever is set while the mirror is in an up-position, the mirror is released. Therefore, always reset the mirror in the up-position after setting the self-timer.
  - If the self-timer lever is turned halfway, the shutter button is locked and doesn't work. It doesn't get out of order, because the shutter button will be released after continuing to turn the lever completely.





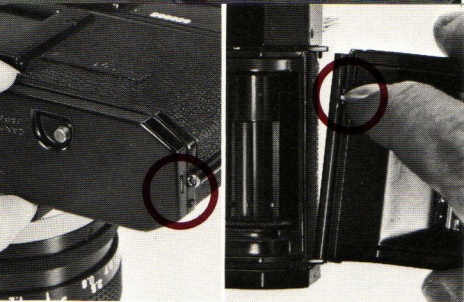

## Removing the Bottom and Back Covers

The bottom cover can be removed for use of the Motor Drive Unit and the Motor Drive MF. When removing the bottom, take off the battery compartment cover and lift the bottom off. The back can be removed for attaching the Film Chamber 250. When removing it, push down the pin of the hinge.

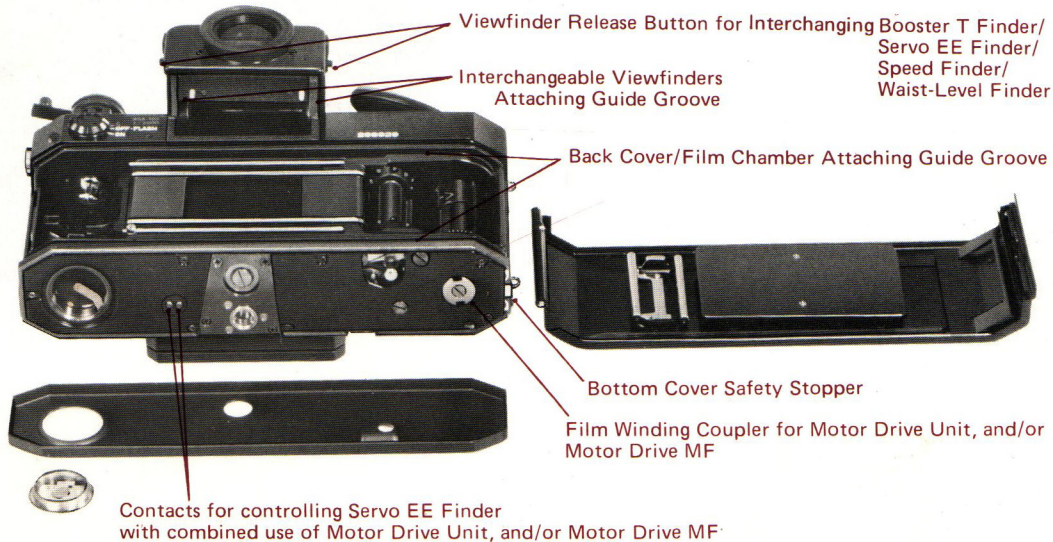

## Fixing the Mirror Upwards

In performing super-telephoto or photomicrography, the Canon F-1 can be operated with the mirror locked in the up-position after the picture has been composed in the viewfinder. To lock the mirror in the up-position, push the stopped-down lever towards the lens and the lock lever to "M". The aperture is now stopped-down and controlled manually.

- The mirror can be locked independently from film advance and shutter speed operations.
- When the mirror is locked in the up-position, SLR viewing is not possible, distance must be estimated by eye, and the 1/2000 second shutter speed cannot be used.
- When the mirror is locked, keep the lens covered if you are not using the camera. The film will sometimes be fogged if the lens cap is left unattached.
- After the mirror lock device has been used, be sure to return the mirror lock lever to its original position. Failure to do this will result in inexact focusing.
- When the original model Canon FL 19mm f/3.5 lens is used, the mirror should be fixed in the up-position. Use of the special viewfinder made for this lens becomes necessary.





# Canon F-1

ACCESSORIES





# Motor Drive System and Power System

## 1. Motor Drive MF

Developed as a sister product of the Motor Drive Unit which has already been highly praised by photographers everywhere, the Motor Drive MF was developed for easier operation while keeping all mechanisms at the highest quality performance level possible in order to fulfill the needs of news and sports photographers. The Motor Drive MF's compact design also makes it exceptionally useful for scientific research.

It enables you to take 3.5 pictures per second and is totally compatible with the full line of accessories for the Canon F-1, especially the Film Chamber 250, Servo EE Finder and Interval Timer L.

## 2. Motor Drive Unit

The Motor Drive Unit is a precision made, electrically powered, film advance apparatus which makes possible not only a wide range of photography with the timer, but also short interval photography of three exposures per second. The timer can be set at seven intervals up to 60 seconds and enables unmanned EE photography when jointly used with the Servo EE Finder. It is easily attached to the base of the camera.

## 3. Film Chamber 250

The Film Chamber 250 is an exclusive long-length film roll magazine designed to hold at capacity 250 exposures. Made to guarantee single-frame exposures, with the combined use of the Motor Drive Unit or the Motor Drive MF, it is effective for shooting sports events and copying documents.

## 4. Battery Case D

## 5. Battery Case

The Battery Case holds an external power source and is used for

1



2



3

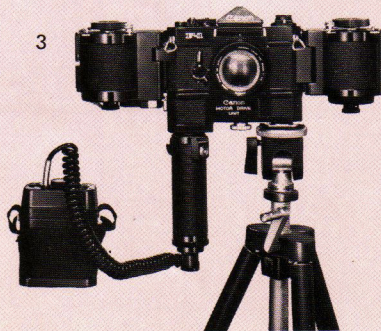

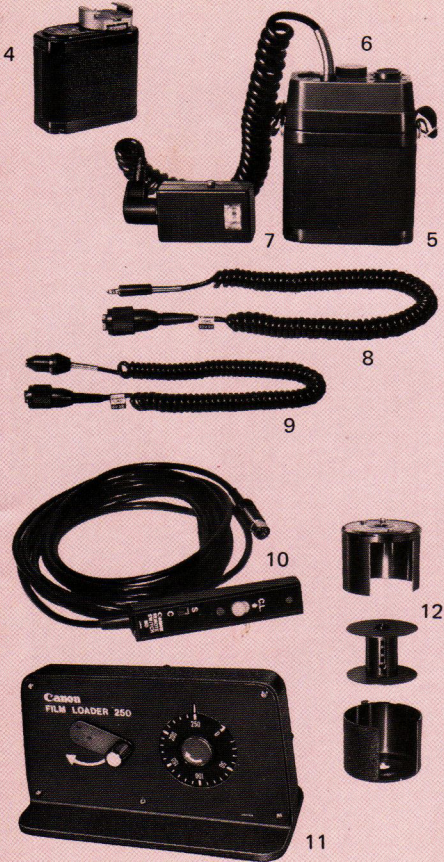

the power drive accessories: Motor Drive Unit, Servo Finder and Booster T Finder. This versatile battery case can use the Battery Magazine 15V containing 10 penlight batteries or Battery Magazine 12V containing 8 penlight batteries.

#### **6. Battery Connector MD**

The Battery Connector MD is used for connecting the Motor Drive Unit to the Battery Case. Without this connector, the Motor Drive Unit cannot be used.

#### **7. Battery Checker**

The Battery Checker MD is used for checking the power level of the battery. It is connected to the cord of the Battery Connector MD.

#### **8. Cord 12V 2E**

The Cord 12V 2E is used for connecting the Servo EE Finder to the Battery Case or the Battery Connector MD.

#### **9. Cord 6V 2B**

This cord is used for connecting the Booster T Finder to the Battery Case.

#### **10. Remote Switch MD**

The Remote Switch MD with a 5 meter (16 foot) long cord is used for photographing with the Motor Drive Unit. It is connected to the Battery Connector MD. Single frame and continuous photography are possible with it.

#### **11. Film Loader 250**

The Film Loader 250 is a film winding device used to load bulk film into the Film Magazine 250 for the Film Chamber 250.

#### **12. Film Magazine 250**

The Film Magazine 250 is for the Film Chamber 250. It can hold a maximum of 250 exposures.



# Viewfinder System

## 1. Servo EE Finder

The Servo EE Finder is an EE, interchangeable viewfinder, which couples to the full aperture metering mechanism of the FD lenses. It presets the proper f/stop automatically with shutter speed priority.

## 2. Booster T Finder

The Booster T Finder with its built-in timer is used for precise exposure reading down to 60 sec. under extremely dim light conditions. Metering range is from EV 10 (f/22 at 1/2 sec.) to EV -3.5 (f/1.2 at 15 sec.) with ASA 100 film.

## 3. Speed Finder

The Speed Finder is an extremely versatile viewfinder used for all kinds of photography, from over head shots to copy work. This viewfinder can be changed into an Eye-Level Finder or Waist-Level Finder by simply adjusting the rear section of the optical system. The eye point of the Speed Finder is located 60mm in back of the eyepiece.

## 4. Waist-Level Finder

The Waist-Level Finder is an interchangeable viewfinder with built-in 5X magnifier glass. This viewfinder is very effective for low position photography and for focusing in copy work.

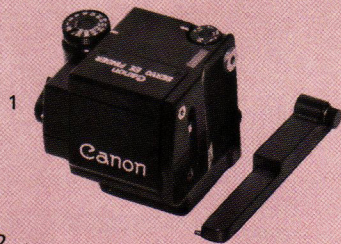





5  
6

### 5. Angle Finder B

The Angle Finder B is a right angle attachment that presents an exact reading of the entire field of view. It is very convenient for copy work, close-up photography and shooting a subject from a low angle.

### 6. Angle Finder A2

The Angle Finder A2 is a simplified version of the Angle Finder B which shows an erect, but reversed image.

### 7. Focusing Screens

Nine types of focusing screens are available: Focusing Screen A (microprism type), B (split-image type), C (all-matte type), D (matte/section type) E (split-image/microprism), F (microprism/large aperture lenses), G (microprism/small aperture lens), H (matte/scale) and I (double cross-hair reticule). Usually, the F-1 is sold with Focusing Screen E.

### 8. Dioptic Adjustment Lenses

Four kinds of interchangeable dioptic adjustment lenses for nearsightedness and six kinds for farsightedness are available: R-0.5, R-2, R-3 and R-4 for nearsightedness; R 0, R+0.5, R+1, R+1.5, R+2 and R+3 for farsightedness. The F-1 comes equipped with the standard lensless R-1 ring.

### 9. Magnifier R

The Magnifier R is used for magnifying the focusing screen so that an accurate focus can be obtained. It can be attached to the eyepiece of the Eye-Level Finder, Booster T Finder or Servo EE Finder.

### 10. Magnifier Adapter S

### 11. Eyecup R

The Eyecup R is an eyepiece hood for shielding out light. This is attached over the eyepiece ring.

7



8



9

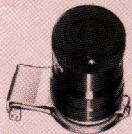

10



11



# Flash Photography System

## 1. Speedlite 133D

The Speedlite 133D is a direct contact electronic flash unit for the matching-needle type, semi-automatic exposure control used in flash photography with the F-1.

## 2. Flash-Auto Ring A<sub>2</sub> and B<sub>2</sub>

The Flash-Auto Ring A<sub>2</sub> is attached when an FD 50mm f/1.8 S.C., FD 35mm f/2 S.S.C. or FD 35mm f/3.5 S.C. Canon lens is mounted. The Flash-Auto Ring B<sub>2</sub> is used for the FD 50mm f/1.4 S.S.C., FD 35mm f/2 S.S.C. or FD 35mm f/3.5 S.C. They are the matching-needle type automatic flash photography accessories which are attached in front of the lens and transmit the distance signal to the meter circuit of the F-1.

## 3. Flash Couplers D and L

The Flash Coupler D is used for the ordinary or direct contact flash unit. When the ordinary flash unit is mounted onto this coupler, its cord should be connected to the flash socket of the camera.

The Flash Coupler L, which has a directly coupled contact for automatic flash photography, is an accessory shoe specially developed for attaching the Speedlite 133D to the F-1. It has a built-in lamp to make the meter needle visible even in very dark surroundings.

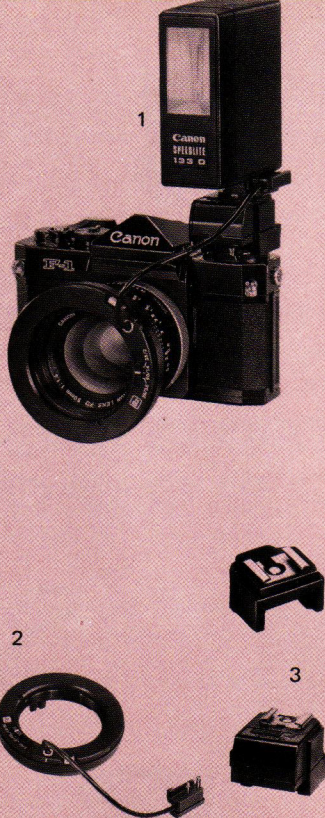



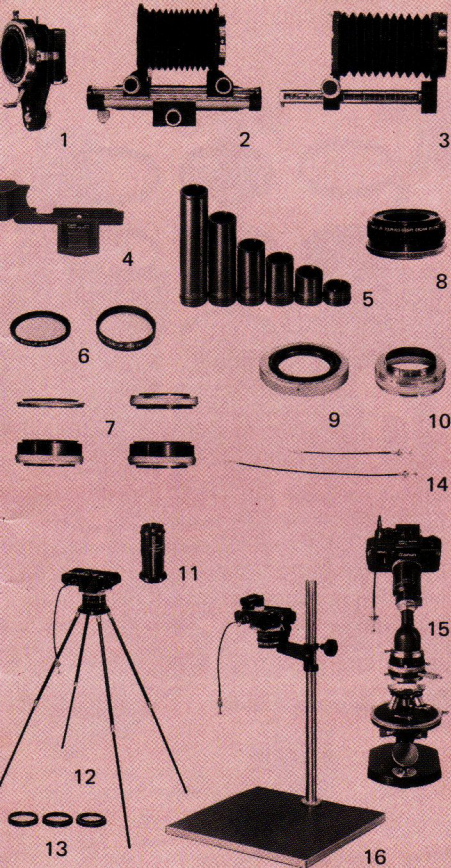

# Close-up, Macrophotography and Photomicrography

## 1. Slide Duplicator

The Slide Duplicator is used for duplicating color slides or black-and-white slides. It is attached to the tip of the Bellows FL.

## 2. Bellows FL

The Bellows FL is used for the extreme close-up photography. It has a shooting distance adjustment mechanism and a mechanism which couples to the automatic diaphragm of the FD and FL lens.

## 3. Bellows M

The Bellows M is a handy bellows for macrophotography. This is used to attach a Macro Lens FL 50mm/ f/3.5, FLM 100mm f/4, FD 50mm f/3.5 S.S.C. or FD 100mm f/4 S.C. to the F-1.

## 4. Camera Holder F3

The Camera Holder F3 is used in combination with a tripod or a Copy Stand 4 for macrophotography and copy work.

## 5. Extension Tubes from 6mm to 200mm

## 6. Close-up Lenses

## 7. Extension Tubes M5, M10, M20

## 8. Macrophoto Coupler FL55, FL58

## 9. Lens Mount Converter A

## 10. Lens Mount Converter B

## 11. Microphoto Hood

## 12. Handy Stand F

## 13. F Rings 55mm, 58mm

## 14. Canon Releases 30, 50

## 15. Photomicro Unit F

## 16. Copy Stand 4



# Filters

Type	Effectiveness of Filters
○● UV	Absorbs only ultra-violet rays. Especially effective at seaside, and on high mountains. Recommended for use in color photography.
○ Y1 Y3	Increases contrast of black and white film. Enhances clouds, darkens the blue sky. Brightens red and yellow.
○ O1	Darkens blue, lightens yellow and red perceptibly. Good for contrasts especially in distant landscapes.
○ R1	Makes strong contrasts. May also be used with infrared film.
○ G1	Prevents red from turning radically into white. Lightens sky and face appropriately, and reflects the lightness of fresh greenery.
○● ND4 ND8	ND4 reduces light values by 1/4, ND8 by 1/8. No effect on the reproduction of colors.
● SKYLIGHT	Acts to harmonize the blue sky and shade.
● CCA4	For use with daylight type film under cloudy conditions.
● CCA8	For use with tungsten type film in the morning sun or sunset.
● CCA (12)	For use with tungsten type film under sunlight.
● CCB4	For use with daylight type film in the morning sun or sunset.
● CCB8	For use with daylight type film and clear flash bulb.
● CCB (12)	For use with daylight type film under tungsten light.

○ For black and white film. ● For color film.

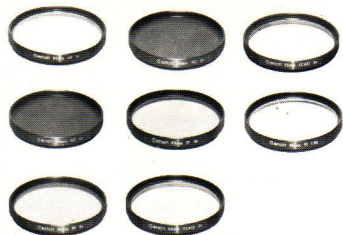

Various types of filters, for different lens thread diameters, are available for special effects in both color and black-and-white photographs. The through-the-lens exposure measurement system of Canon F-1 does not require exposure factor compensation for filters.

## Other Accessories

Case S for FD 50mm f/1.8 S.C. FD 50mm f/1.4 S.S.C.

Case L for FD 55mm f/1.2 S.S.C.

Finder Dust Cover

Lens Hood BW-55A

Lens Hood BW-55B

Lens Hood BS-55

Lens Hood BS-58

Lens Hood BT-55

Lens Cap C55

Lens Cap C58

Lens Dust Cover

55mm Close-up Lens 240, 450

58mm Close-up Lens 240, 450

Neck Strap 6 w/pad

Gadget Bag 4

Gadget Bag G-1

M20 (#625) Mercury Battery

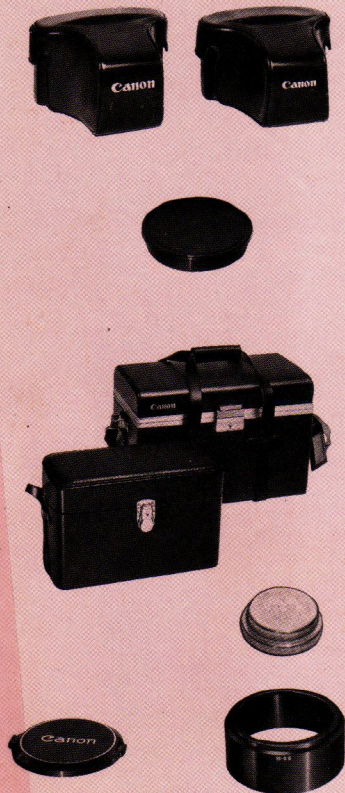

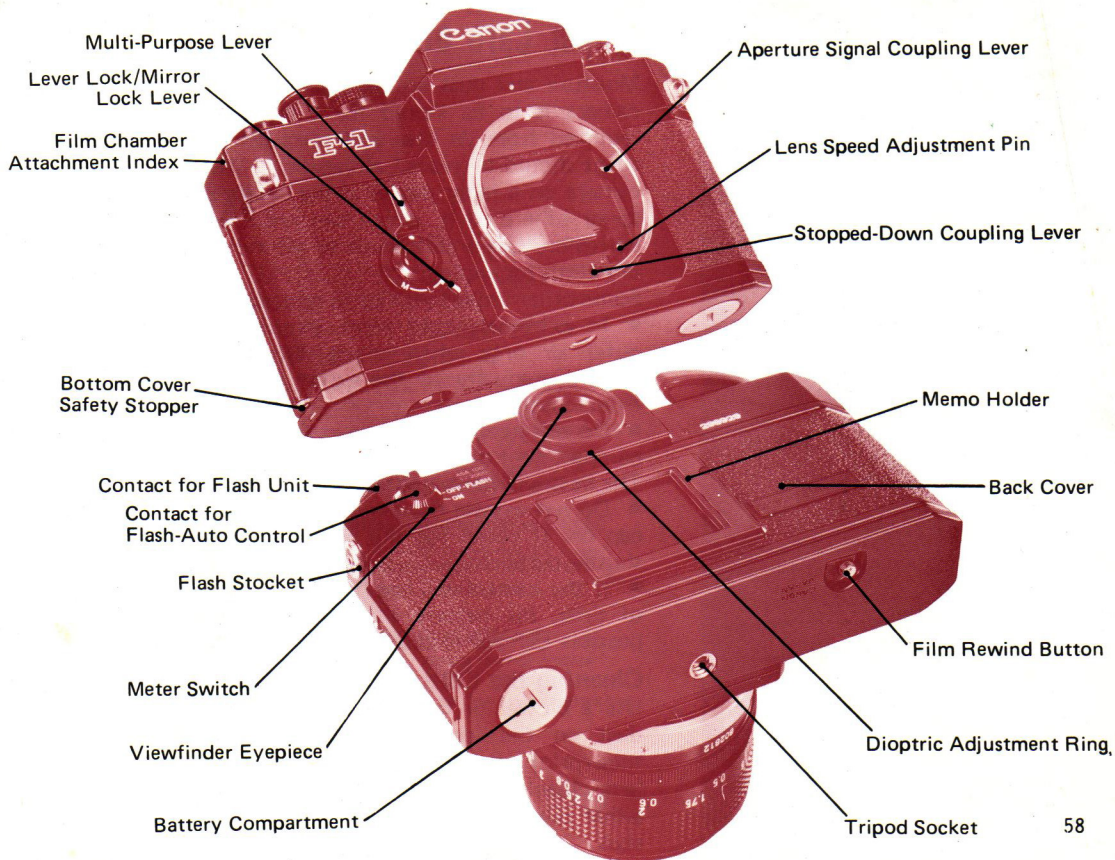



## Proper Care of the Camera

Moisture and dust are harmful to your camera. If your camera is to be stored for a long time, it should be removed from its case and silica gel or another drying agent should be placed alongside it. When you use your camera on a rainy day or at the beach, moisture and salt spray adhere to it, which can result in stains, rust and corrosion. Use a soft brush to get rid of dust and a soft dry cloth for wiping.

Some other important tips to remember are:

- In extremely cold areas, expose the camera to the outer air only when in use. When using, expose the camera gradually to the outer air to prevent the lens from clouding.
- Do not keep the camera in a hot place such as a glove compartment or the rear window shelf of an automobile. The heat will harm your camera and film.
- Do not expose the camera to the sun without the lens cap on. It could fog the film or burn a pin-hole in the shutter curtain.
- If the camera will not be used for an extended length of time, the battery should be taken out to prevent possible damage to the terminals from battery corrosion.

### Cleaning the Lens

Use a blower or brush lightly with a brush to remove dust on the lens. If you should advertently get a fingerprint on the lens, wipe in a circular motion with lens cleaning material that has been lightly dipped in either pure alcohol or ether and wrapped around a match stick.

Camera Body Number \_\_\_\_\_

Lens Number \_\_\_\_\_

Date of Purchase \_\_\_\_\_

Dealer's Name \_\_\_\_\_

# Canon

**CANON INC.** 11-28, Mita 3-chome, Minato-ku, Tokyo 108, Japan

- U.S.A.** — **CANON U.S.A. INC. HEAD OFFICE**  
10 Nevada Drive, Lake Success, Long Island, N.Y. 11040, U.S.A.  
**CANON U.S.A. INC. MANHATTAN OFFICE**  
600 Third Avenue, New York, N.Y. 10016, U.S.A.  
**CANON U.S.A. INC. ATLANTA SERVICE STATION**  
160 Peachtree Street, N.W., Atlanta, Georgia 30303, U.S.A.  
**CANON U.S.A. INC. CHICAGO OFFICE**  
140 Industrial Drive, Elmhurst, Illinois 60126, U.S.A.  
**CANON U.S.A. INC. LOS ANGELES OFFICE**  
123 Paularino Avenue East, Costa Mesa, California 92626, U.S.A.  
**CANON U.S.A. INC. LOS ANGELES SERVICE STATION**  
3407 West 6th Street, Los Angeles, California 90020, U.S.A.  
**CANON U.S.A. INC. SAN FRANCISCO SERVICE STATION**  
776 Market Street, San Francisco, California 94102, U.S.A.  
**CANON U.S.A. INC. HAWAII OFFICE**  
Bldg. B-2, 1050 Ala Moana Blvd., Honolulu, Hawaii 96814, U.S.A.
- CANADA** — **CANON OPTICS & BUSINESS MACHINES CANADA, LTD.**  
**HEAD OFFICE**  
3245 American Drive, Mississauga, Ontario, L4V 1N4, Canada  
**CANON OPTICS & BUSINESS MACHINES CANADA, LTD.**  
**MONTREAL OFFICE**  
3070 Brabant-Marineau Street, St. Laurent, Quebec, H4S 1K7, Canada  
**CANON OPTICS & BUSINESS MACHINES CANADA, LTD.**  
**VANCOUVER OFFICE**  
735 Elmbridge Way, Richmond, B.C., V6X 1B8, Canada
- EUROPE, AFRICA & MIDDLE EAST** — **CANON AMSTERDAM N.V.**  
Gebouw 70, Schiphol Oost, Holland
- CENTRAL & SOUTH AMERICA** — **CANON LATIN AMERICA, INC. SALES DEPARTMENT**  
P.O. Box 7022, Panama 5, Rep. of Panama  
**CANON LATIN AMERICA, INC. REPAIR SERVICE CENTER**  
P.O. Box 2019, Colon Free Zone, Rep. of Panama
- SOUTHEAST ASIA** — **CANON INC. HONG KONG BRANCH**  
5th Floor 2-6, Fui Yiu Kok Street, Tsuen Wan, New Territories, Hong Kong