

# WILSONWERKS ARCHIVES

This camera manual is for reference and historical purposes, all rights reserved.

This cover page is copyrighted material. This document may not be sold or distributed without the express consent of the publisher.

©2008 wilsonwerks Llc

INSTRUCTIONS

# Canon FTb



English Edition



We are highly gratified that you have selected the Canon FTb—a wise choice that promises you many delightful years of photographic experiences. Canon is recognized the world over as the foremost pioneer in the development of photographic equipment of the highest quality and performance. Whether your FTb is for the home, laboratory, or for traveling, make the most of your opportunities!

### **Before Using ...**

Please read this instruction booklet carefully, and master the manipulation of the various parts of the FTb completely. When thoroughly versed in the correct handling of this camera, you can use the Canon FTb to the fullest extent of its capabilities.



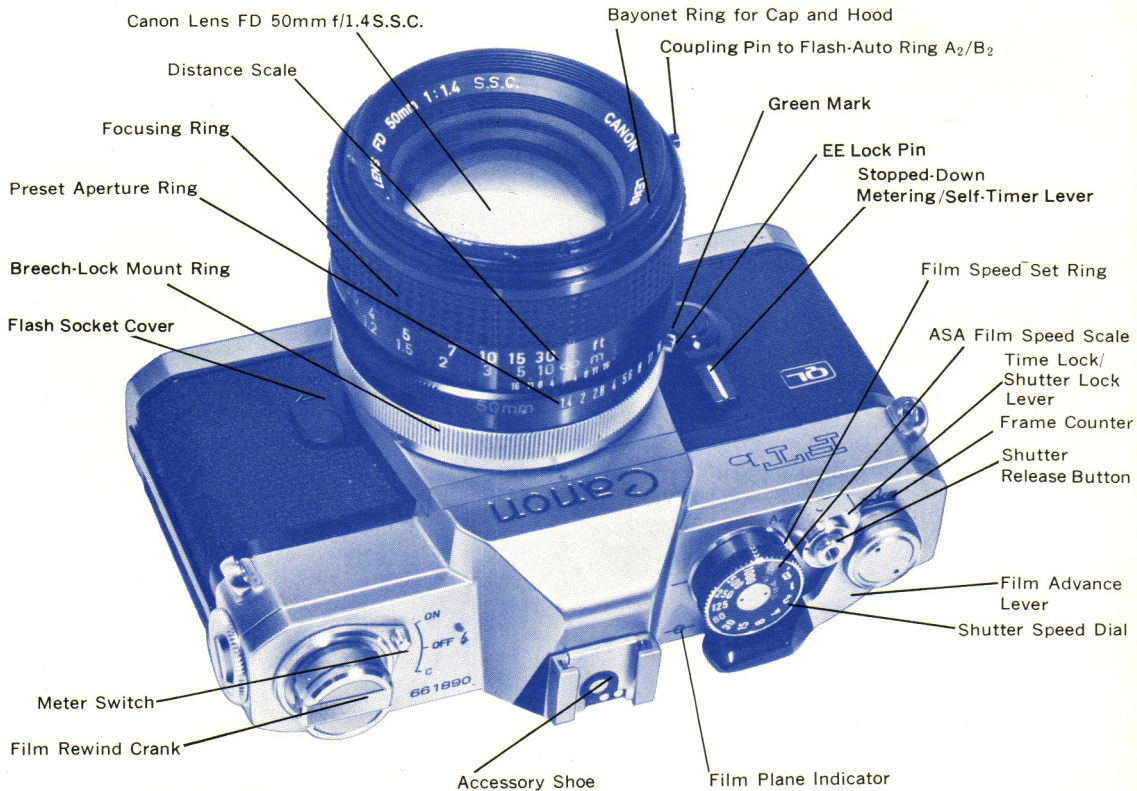





# Contents

Technical Data . . . . .	8
Mercury Battery Loading and Checking . . . . .	10
Film Winding . . . . .	12
Shutter and Aperture Adjustment . . . . .	14
Using Built-in Exposure Meter . . . . .	18
Exposure Settings . . . . .	20
Coupling Range of Built-in Exposure Meter . . . . .	24
Viewing and Focusing. . . . .	25
Holding the Camera . . . . .	27
Film Loading . . . . .	29
Film Rewinding . . . . .	32
Synchronizing Flash Unit . . . . .	33
Uses of the Lenses . . . . .	35
Using Self-Timer . . . . .	41
Double Exposures . . . . .	42
Filters . . . . .	43
Interchangeable Lenses and Accessories. . . . .	44
Proper Care of the Camera . . . . .	47

# Follow These Simple Steps for Normal Photography

**1** Load the film with the QL mechanism.

**2** Set the ASA film speed.

**3** Wind the film advance lever.

**4** Remove the lens cap.

6

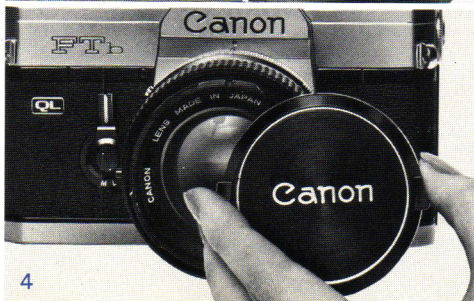
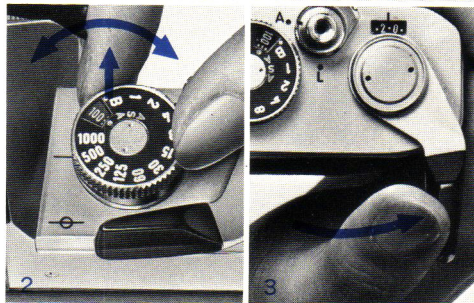
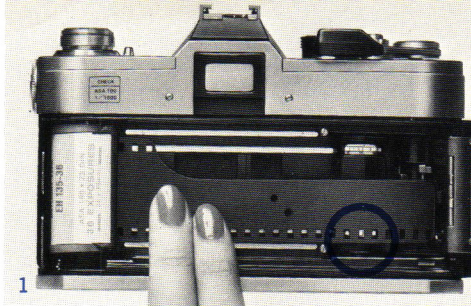





**5** Look through the viewfinder and focus.

**6** Determine the exposure by adjusting the shutter speed dial and the preset aperture ring.



**7** Compose the picture.

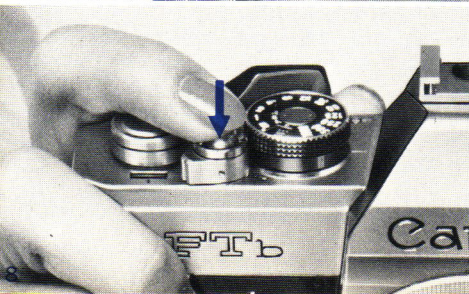

**8** Press the shutter release button gently.

## Technical Data

- Type: 35mm single-lens reflex camera with focal plane shutter. Picture size, 24 x 36mm.
- Interchangeable Lenses: Canon FD series lenses with full aperture signal lever.
- Standard Lens: Canon lens FD 55mm f/1.2 S.S.C., FD 50mm f/1.4 S.S.C., FD 50mm f/1.8 S.C.
- Viewfinder: Eye-level using pentagonal prism. Angle Finders A2 and B, Magnifier S, Dioptic Adjustment Lenses can be attached.
- Focusing Screen: Using Fresnel lens and microprism screen rangefinder. With metering beam-splitting condenser.
- Field-of-View: 94% of actual picture area. 0.85x with standard 50mm lens at infinity.
- Viewfinder Information: Meter needle and aperture needle, shutter speed indicator, red signal indicating outside lower side of meter coupling range, meter index for stopped-down metering and battery check, and coupling range limit marks.
- Dioptic Adjustment Lenses: Standard -1.2 diopter. Interchangeable with +1.5, 0, -2.5, and -4.
- Mirror: Shockless quick return system. Mirror can be fixed in upward position.
- Lens Mount: Canon breech-lock FD mount. FL and R series of lenses mountable.
- Coupling Function of Lenses: FD lenses: full aperture metering, coupled with automatic diaphragm. FL lenses: stopped-down metering, coupled with automatic diaphragm. R lenses: stopped-down metering, manually operated diaphragm.
- Shutter: Focal plane shutter with speeds from 1/1000 to 1 sec. and B. Multiple series. Equiinterval index. X contact at "60". Shutter release button can be locked.
- Self-Timer: Built in. Activate with shutter release button. Approx. 10 sec. time lag. Self-timer lever is used in common as stopped-down functioning lever.
- Film Speed Scale: ASA 25-2000.
- Exposure Meter: Built in. Using CdS photocell. Coupled to shutter speeds, film speeds and f/stop. Match needle type full aperture measuring mechanism. Central area metering system, measures 12% of picture area. Stopped-down metering possible. Fixed dot type metering,



using stopped-down lever. Lockable. Powered by one 1.3v M20 (#625) mercury battery. Battery checker built in.

■ Exposure Meter Coupling Range: With ASA 100 film, EV 2.5 (f/1.2 at 1/4 sec.)-EV 18 (f/16 at 1/1000 sec.).

■ Ultra-low Illumination Metering: Metering possible between ASA 100 film EV 10 (f/22 at 1/2 sec.) and EV -3.5 (f/1.2 at 15 sec.) with use of Canon Booster.

■ Flash Synchronization: FP and X contact. Automatic time lag adjusting type. Flash socket on front side of body. Two exclusive contacts on accessory shoe.

■ Canon Auto Tuning (CAT) System: Aperture control by recharging power level signal and distance signal. Proper aperture obtained by meter matching needle system through connection of Canon Speedlite 133D, Flash Coupler A<sub>2</sub>/B<sub>2</sub> and prescribed FD 50mm f/1.4 S.S.C., FD 50mm f/1.8 S.C., FD 35mm f/3.5 S.C. or FD 35mm f/2 S.S.C. lenses.

■ Synchronizing Range: FP class; 1/1000-1/125 sec., 1/30 sec. or under. Speedlite; 1/60 sec. or under. M, MF class; 1/30 sec. or under.

■ Film Loading: By opening back cover. Accepts any standard 35mm film roll in cartridge. QL mechanism for quick loading of film.

■ Film Advance Lever: Single operation 174°. Short-stroke winding possible.

■ Film Rewinding: Performed by rewind button and crank.

■ Double Exposure: Possible by operating film rewind button and crank.

■ Frame Counter: Self-resetting type activated by opening back cover.

■ Size: 144 x 93 x 43mm (5 $\frac{5}{8}$ " x 3 $\frac{3}{8}$ " x 1 $\frac{3}{4}$ ".)

■ Weight: 750g (1 lb. 10- $\frac{1}{2}$  ozs.)—body only.

Subject to alterations.



"Spectra Coating" and "Super Spectra Coating" shall be abbreviated as "S.C." and "S.S.C." respectively.

## Mercury Battery Loading and Checking

The built-in exposure meter of the Canon FTb functions only when the mercury battery is properly loaded.

- 1 To remove insert a coin into the groove of the battery compartment cover and turn it to the left.
- 2 Face the central contact ( $\ominus$ ) of the mercury battery inwards and insert.
- 3 Replace the cover by turning it to the right.

- Before inserting, wipe off the fingerprints or stains from the battery poles with a dry cloth. Otherwise, the meter may not function due to imperfect contact, and dirty poles may cause corrosion and damage the contact points of the camera.

- A 1.3 v M20 (#625) mercury battery should be used—equivalent to the Mallory PX-625, Eveready EPX-625.

- Be sure to insert the battery in the correct direction by referring to the diagram on the compartment cover. Otherwise, the cover cannot be properly screwed in.

- If the camera will not be used for an extended length of time, the battery should be taken out of the battery compartment to prevent possible damage to the terminals from battery corrosion.





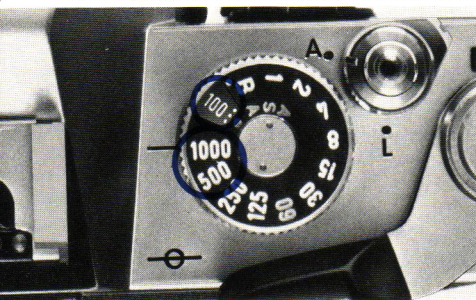
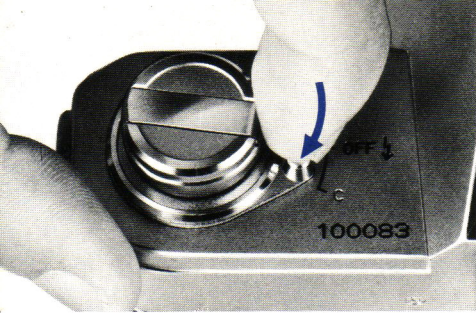

## Battery Check

Check the power level of the mercury battery after loading it.

**1** Set the film speed scale at ASA 100 and the shutter speed dial at "1000". For setting the film speed, lift up the outer ring of the shutter speed dial and turn. (See page 19.)

■ It cannot be checked correctly if other settings are used.

**2** Turn the meter switch, on the outer side of the film rewind crank, to the "C" index.

**3** If the meter needle inside the viewfinder swings to the meter index, the battery has sufficient power. If the needle stays below the meter index, voltage is insufficient and the battery must be replaced.

■ When removing your finger from the meter switch, it will automatically return to the "OFF" index from "C".

■ The battery in normal use lasts approximately one year.

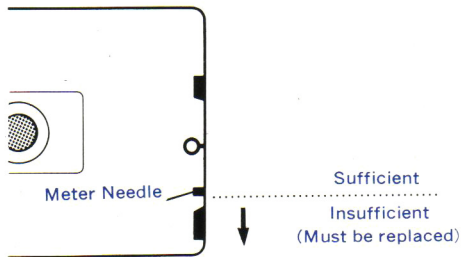



## Film Winding

The film advance lever winds the film, cocks the shutter, and prepares the aperture and mirror for the next shutter release all in one motion.

**1** Turn the film advance lever until it stops. The film will be advanced one frame and the shutter cocked. The frame counter is simultaneously advanced to the next number.

**2** When the shutter release button is pressed, the mirror flips up, the diaphragm simultaneously closes down to the preset f/stop and the shutter operates. After the shutter is operated, the advance lever can be wound for the next frame.

- Be sure to set the shutter lock lever at "A".
- Winding may be done by moving the lever with several short strokes.
- After loading the film, make another wind, because the first winding may not be complete.
- The shutter will not function when pressing the shutter release button unless winding is completed. In such a case, check the winding once more.

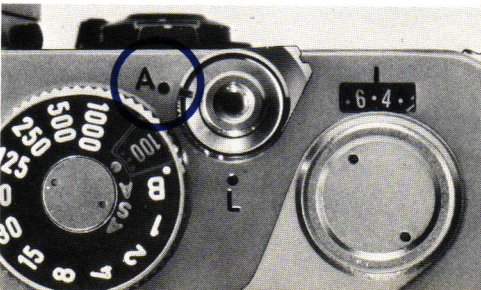
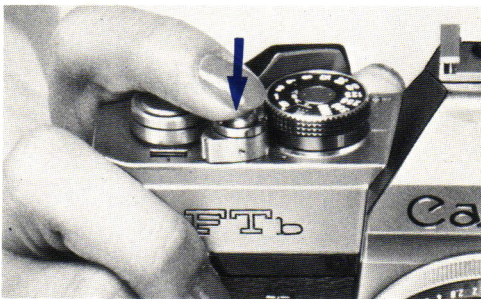
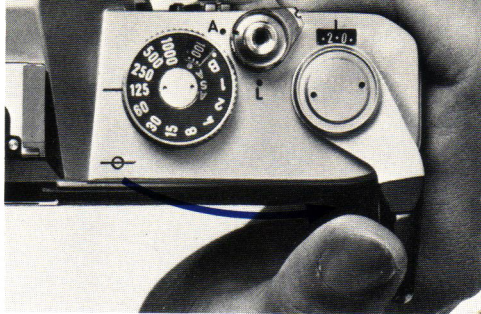

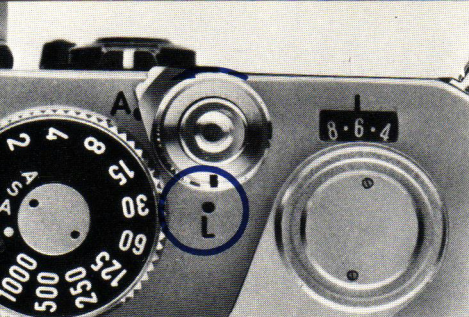

### Frame Counter

Each winding will advance the number of the frame counter, indicating the number of pictures taken. When the back cover is opened, the counter automatically returns to the starting position "S".

### Safety Device for Shutter

When the shutter lock lever around the shutter release button is turned to the "L" position, the shutter is locked and will not move. This device may be used when a loaded camera is being carried around.

### Attaching the Cable Release

The optional Canon Release can be attached to the FTb by screwing it into the threaded hole in the center of the shutter release button. The use of a cable release is recommended when photographing with extended time exposure or slow shutter speeds, and for copy work.

Even if the shutter lock lever is at "L" position, the shutter will operate by using the release.

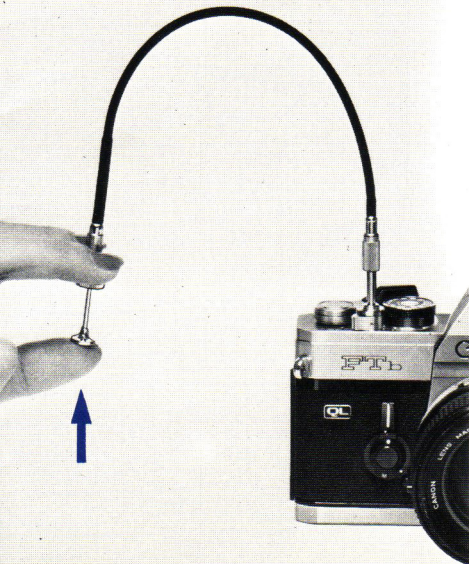



# Shutter and Aperture Adjustment

Exposures are adjusted by the shutter and aperture. The shutter controls the exposure time and the aperture controls the amount of incoming light. The Canon FTb uses a match needle meter, a very simple method of obtaining proper exposures.

## Shutter Speed Dial

Adjust the shutter speed by turning the shutter speed dial to the desired index number. The index on the dial shows the denominators of 1/1000 sec., 1/500 sec., etc.

- The shutter speed dial does not revolve between indexes "1000" and "B".

- Be sure to set the index at a position where the click-stop catches. In case of the "B" index, adjust it to the white dot just below it.

- "B" indicates bulb exposure, and is used when making exposures of more than one second. When the shutter speed dial is set at "B", the shutter remains open as long as the shutter release button is pressed.

- When time exposure is necessary to make an exposure over an extended time, first set the shutter speed dial at "B". Keep the shutter release button pressed, and turn the time lock lever to "L". The shutter remains open even if the finger is removed from the button. When the lever is returned to "A", the shutter closes.

- Time exposure is also possible by using the lockable

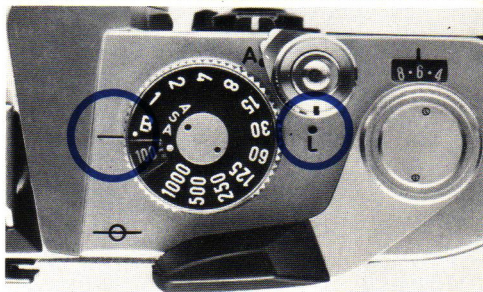
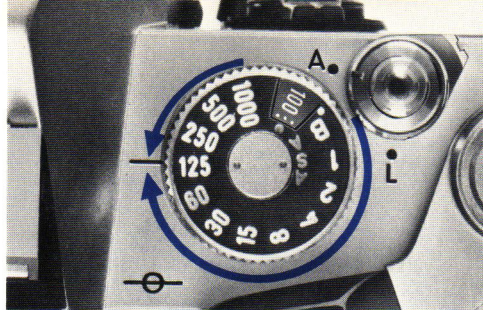



cable release.

- It is possible to perform a long-time exposure measurement by attaching the optional Canon Booster, the auxiliary meter for measuring subjects under dim light.

- The “60” index is used for synchronizing an electronic flash unit such as Canon Speedlite. It is equivalent to a very short exposure time during the flash of the flash unit. With this camera, the shutter speed can be confirmed at the bottom left of the viewfinder.

## Aperture

Incoming light and depth of field are adjusted by turning the preset aperture ring to the desired f/stop.

- As the f/stop number becomes larger, the amount of light reaching the film plane becomes proportionally less. For each f/stop up, the light is reduced one-half. Accordingly, when the aperture is increased by one f/stop, the exposure is doubled, and when it is increased by two f/stops the exposure is quadrupled.

- Certain lenses, however, have no relation to the brightness halved between the maximum and the next f/stops on the preset aperture ring.

- The ratio between the aperture and the amount of exposure, using f/2 as the basis, is as follows:

f/stop:

1.2 1.4 1.8 **2** 2.8 3.5 4 5.6 8 11 16 22

Exposure Ratio:

3 2 1.25 1 1/2 1/3 1/4 1/8 1/16 1/32 1/64 1/128

- The preset aperture ring can also be set between two f/stops.

## Presetting Aperture

In the case of the FD or FL lens, the field of view can always be seen through the viewfinder at full aperture opening even after the f/stop has been set with the preset aperture ring. Set the desired f/stop on the preset aperture ring to the index. The diaphragm will close down to the preset f/stop only for the instant that the shutter is released. Except for that instant, the diaphragm remains fully open.

## Manual Control of Aperture

1 By pressing down or locking the stopped-down lever and turning the preset aperture ring, the diaphragm can be closed down to any f/stop and the depth of field at the time of shutter release can be checked. When the lever is returned to its original position, the diaphragm again returns to maximum opening.

- The aperture is manually stopped down also when performing close-up photography and macrophotography.

2 When an accessory is used between the lens and the camera body, turn the automatic/manual aperture lever of the lens counterclockwise all the way before mounting the lens. This locks the lever and the diaphragm can be opened or closed by turning the preset aperture ring. For releasing the lever, turn it clockwise.



FD 50mm f/1.4 S.S.C.



Automatic/Manual Aperture Lever





FD 50mm f/1.8 S.C.



Manual Lock Lever  
Automatic/Manual  
Aperture Lever

**3** In case of the Canon FD Lens 50mm f/1.8 S.C., turn the automatic aperture lever of the lens counterclockwise all the way and set the manual lock lever at "L" position before mounting the lens. This manual lock lever locks the automatic aperture lever and the diaphragm can be opened or closed by turning the preset aperture ring. For releasing the lever, return the manual lock lever to the original position (white dot).

With the use of this lock, photography using manually operated aperture can also be performed on Canon's single-lens reflex cameras such as the FX besides the TLb, FTb, FT QL and F-1. But do not use it with Canonflex R, RP, RM and R2000.

**4** When using the lens attached reversely to the macrophoto coupler for duplicating photography, macrophotography, etc., set the automatic aperture lever of the lens in the position for manual operation, attach the hood of the macrophoto coupler to the mounting section of the lens, and turn the breech-lock mount ring until it locks.

## Using Built-in Exposure Meter

Canon FTb provides the most accurate light measurement possible with its unique TTL (Through-The-Lens) system. The built-in exposure meter, which is of the matching needles type, is coupled to the ASA film speed scale, shutter speed dial and preset aperture ring.

The CdS photocell of the exposure meter is placed in the closest position to the beam-splitting condenser lens. The central area metering system enables accurate measurement of the main subject even against the light.

The rectangular frame in the viewfinder represents the light measurement area of the CdS photocell. Place the main subject within this frame and measure the intensity of light so as to obtain the proper exposure.

- The correction of the full aperture opening of the lens is performed automatically. Therefore, the operation does not change regardless of the speed of the lens used. An FL lens can be used only with stopped-down metering.

- Due to the characteristics of the CdS photocell, the movement of the meter needle may occasionally become slack, owing to changes in the degree of light.

- Metering at "B" on the shutter speed dial is not possible with the built-in exposure meter, because "B" is used for exposures longer than one second.

- Always use a lens hood when shooting against the light.

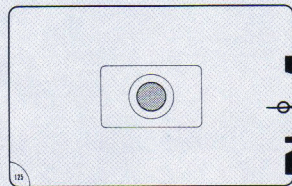
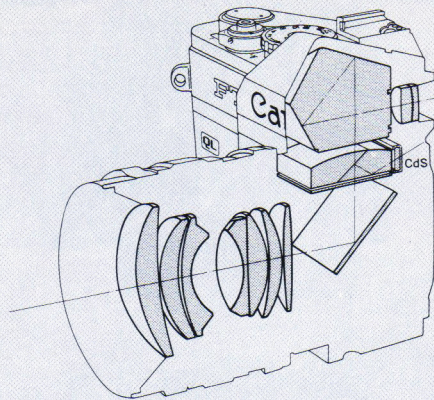

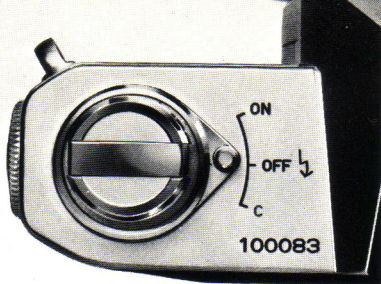

■ When not using the camera, set the meter switch at "OFF" or attach the lens cap so as to prevent unnecessary consumption of the mercury battery.

### Film Speed Setting

Set the ASA film speed scale to the speed of the film being used. Film speeds are normally shown on the film box cover and/or explanatory sheet.

Lift and turn the film speed set ring around the shutter speed dial. If the film is ASA 100, for example, make the correct setting by showing "100" in the small window.

■ The following film speeds may be used :

	(32)	(40)	(64)	(80)	(125)	(160)	(250)	(320)	(500)	(640)	
ASA	25	· ·	50	· ·	100	· ·	200	· ·	400	· ·	800
DIN	15	· ·	18	· ·	21	· ·	24	· ·	27	· ·	30
	(16)	(17)	(19)	(20)	(22)	(23)	(25)	(26)	(28)	(29)	
	(1000)	(1250)	(2000)								
	· ·	1600	·								
	· ·	33	·								
	(31)	(32)	(34)								

Figures in parentheses represent intermediate film speeds.

■ When "25" appears in the small window, it means the film speed setting ring will not turn any further to the left. The dot at the right-turn limit reads ASA 2000.

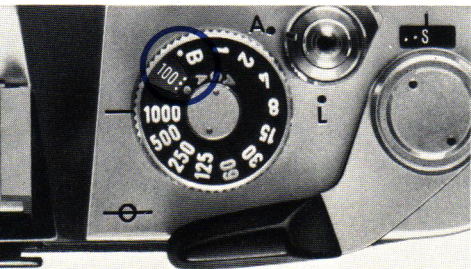
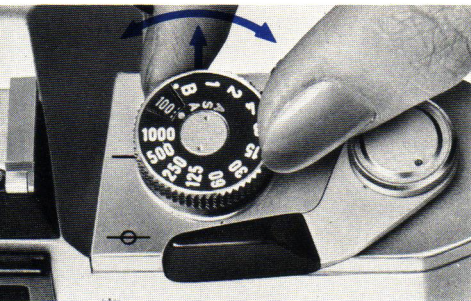



# Exposure Settings

## Full Aperture Metering

Full aperture metering can be performed with an FD lens which has an aperture signal lever and pin.

- 1 Set the meter switch at "ON".
- 2 Set the shutter speed dial at the desired speed.
- 3 Face the camera towards the subject, look into the viewfinder, and check the position of the meter needle and aperture needle.
  - The meter needle is coupled to the film and shutter speeds, and moves vertically according to the brightness of the subject. The aperture needle, with a round circle, is coupled to the preset aperture ring of the FD lens.
- 4 Turn the preset aperture ring and align the aperture needle with the meter needle.
  - The green mark (circle) on the preset aperture ring is for the Servo EE Finder to be used with the Canon F-1 only.
  - In case of f/stop priority, turn the shutter speed dial and align the meter needle with the aperture needle. Be sure to set the shutter speed dial at the click-stop positions.
- 5 If the aperture needle does not align with the meter needle by turning the preset aperture ring, it means that the shutter speed is not properly set. In this case,

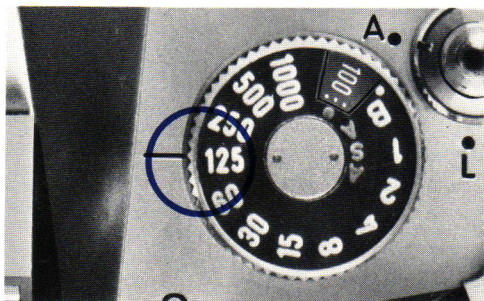
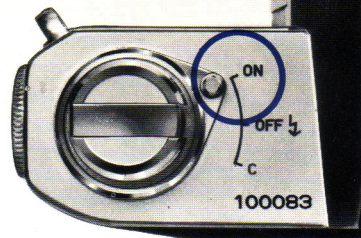

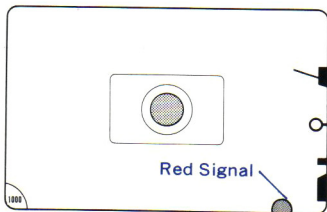
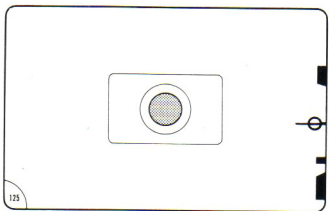
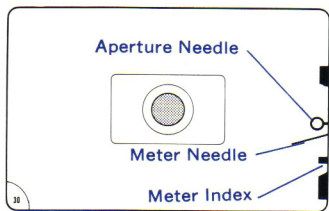

(Outside the Coupling Range)

align the two needles by turning the shutter speed dial.

■ The moving range of the aperture needle inside the viewfinder changes according to the lens speed. Thus, it will not always move vertically the full length of the viewfinder. Change the shutter speed when the aperture needle cannot be aligned with the meter needle.

**6** When the shutter is set on the high speed side, the meter needle moves downward. When it is set at a slower speed, the needle moves upward. When the shutter is set at a slow speed outside the meter coupling range, the red signal appears at the bottom of the viewfinder, and metering is not possible even if the f/stop is changed. When the red signal appears and metering cannot be performed, use high-speed film or the optional Canon Booster. Refer to "Coupling Range of Built-in Exposure Meter" on page 24.

■ Select a faster shutter speed when the meter needle swings all the way up, and a slower speed when it swings all the way down.

■ Since the shutter speed dial cannot be set at the intermediate positions, the shutter speed priority method is recommended when exposure accuracy is a crucial factor.



## Stopped-Down Metering

When using a lens having no full aperture metering signal such as the FL lenses, metering should be performed by stopping down the lens. Stopped-down metering is performed by pushing down the stopped-down lever.

The stopped-down lever can be fixed for continuous light measurement by pressing it towards the lens after setting the lever lock at "L" position. With the fixing of the lever, shooting subjects with different light intensity or telephoto lenses can be conveniently handled. By returning the lock to the white dot position, the metering lever will return to its original position.

- 1 Set the meter switch at "ON"
- 2 Set the shutter speed dial at the desired speed.
- 3 Face the camera towards the subject, look into the viewfinder, and press the stopped-down lever all the way until it stops. The aperture needle will point to the lower coupling limit mark and only the meter needle remains.
- 4 Turn the preset aperture ring and make the meter needle stop within the meter index in the viewfinder.
  - In the case of f/stop priority, adjustments can be made with the shutter speed dial.

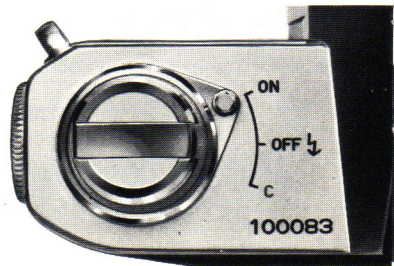
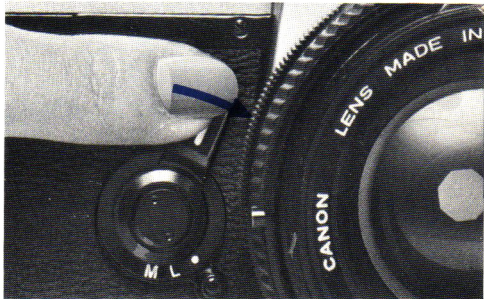
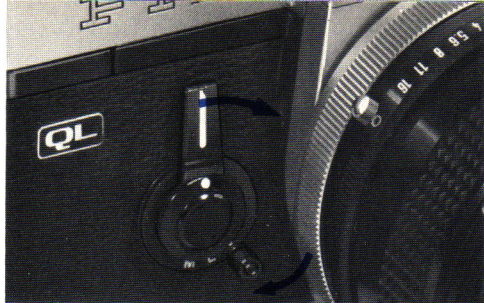

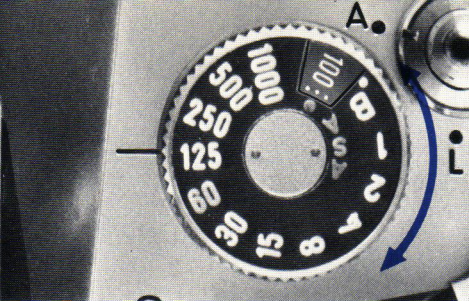

**5** If the meter needle is pointing above the meter index and cannot be matched by closing the preset aperture ring and, consequently, metering cannot be performed, turn the shutter speed dial to the faster side. If the meter needle is pointing below the meter index and cannot be matched by opening the preset aperture ring, turn the shutter speed dial to the slower side. When the red signal appears, use high-speed film or the Canon Booster.

■ Full aperture metering is rather recommended with the FD lenses, because the FD lenses have a full aperture signal so as to fully compensate the built-in exposure meter.

■ The center of the meter index shows the correct exposure and it moves over a range equivalent to one half of one f/stop.

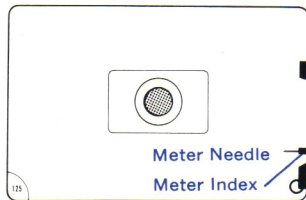

## How to "Average" Exposures

When measuring a subject with dark and bright parts, markedly contrasting, take two measurements, one each of the dark and bright parts. Then obtain the average value and set the f/stop or shutter speed accordingly.

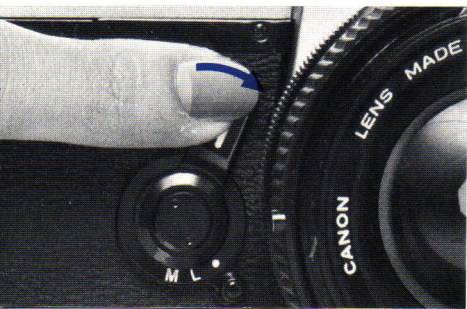

## Coupling Range of Built-in Exposure Meter

Film Speed	Shutter Speed										
ASA 25	1	1/2	1/4	1/8	1/15	1/30	1/60	1/125	1/250	1/500	1/1000
ASA 50	1/2	1/4	1/8	1/15	1/30	1/60	1/125	1/250	1/500	1/1000	...
ASA 100	1/4	1/8	1/15	1/30	1/60	1/125	1/250	1/500	1/1000	...	...
ASA 200	1/8	1/15	1/30	1/60	1/125	1/250	1/500	1/1000	...	...	...
ASA 400	1/15	1/30	1/60	1/125	1/250	1/500	1/1000	...	...	...	...
ASA 800	1/30	1/60	1/125	1/250	1/500	1/1000	...	...	...	...	...
ASA 1600	1/60	1/125	1/250	1/500	1/1000	...	...	...	...	...	...
Minimum f/stop	f/22	f/22	f/22	f/22	f/22	f/22	f/22	f/22	f/16	f/11	f/8

The built-in exposure meter couples to the following range of f/stops and shutter speeds with the respective film speeds. When using the Canon Lens FD 50mm f/1.4 S.S.C. and ASA 100 film, for example, the exposure meter couples fully within the range of f/1.4 at 1/4 sec. (EV 3) and f/16 at 1/1000 sec. (EV 18).



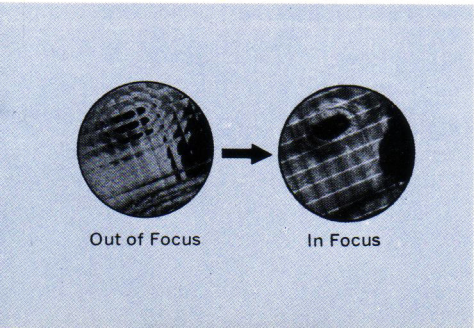
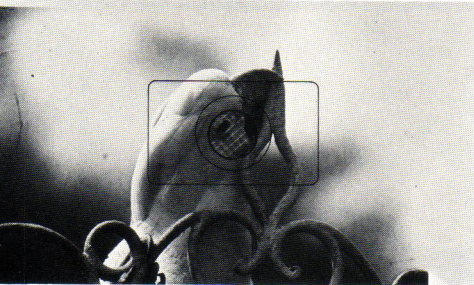

## Viewing and Focusing

### Composition

The exact picture image to be photographed can be seen on the focusing screen of the viewfinder without any parallax. This enables you to determine the exact composition of your scene before pressing the shutter release button.

### Focusing

The center circular section of the viewfinder is a micro-prism screen rangefinder made up of microscopic prisms for fast and precise focusing.

While looking through the viewfinder, revolve the focusing ring. It is in focus when the image in the rangefinder becomes sharp and clear.

- An optical curve may sometimes be visible in the lower part of the viewfinder according to the angle of the incoming light. This is a reflection of the beam-splitting mirror added onto the condenser lens in the TTL light measurement system.

## Dioptric Adjustment Lenses

Dioptric adjustment lenses are available as optional attachments. When a dioptric adjustment lens is attached to the viewfinder eyepiece, those who are far- or near-sighted can take pictures without glasses. Four different diopters of +1.5, 0, -2.5 and -4 are available.

## Angle Finders A2 and B

Canon Angle Finders A2 and B can be attached to the eyepiece for copying, macrophotography and photomicrography. You will see the right and left sides of the image in reverse with the Angle Finder A2, and upright with the Angle Finder B.

## Magnifier S

The Canon Magnifier S can be attached to the viewfinder eyepiece of the FTb, with the separately available adapter which magnifies the rangefinder section for accurate focusing. Because it can be sprung up and clamped, the entire field of view can easily be viewed after focusing.

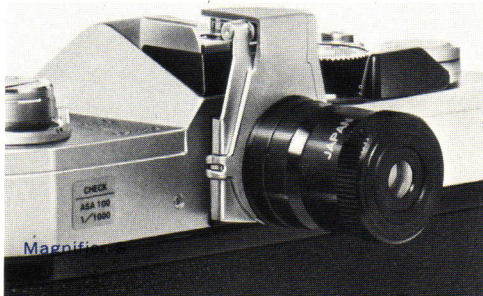
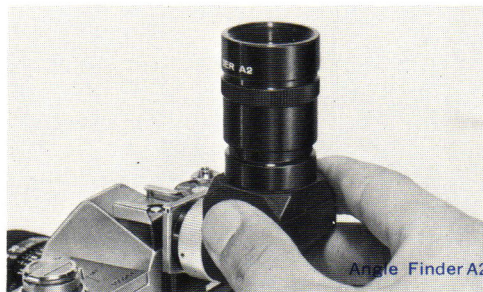
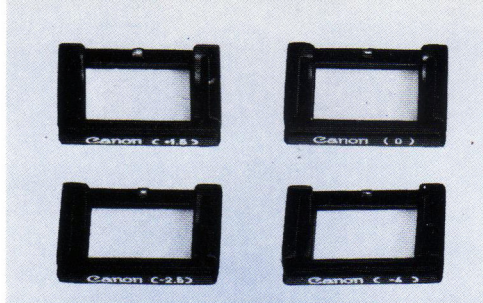

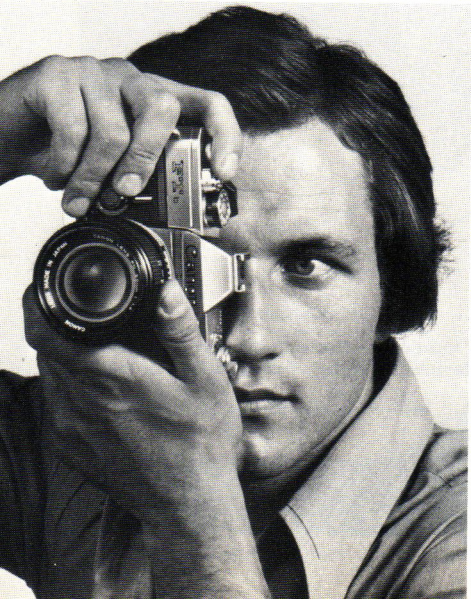

## Holding the Camera

Hold the camera firmly in order to take a clear picture. Hold the camera either in a vertical or horizontal position, look through the viewfinder, and focus. Then press the shutter release button gently. The following steps are important.

- 1** Hold the camera snugly in both hands. The camera should be pressed firmly to your cheek or forehead.
- 2** When the camera is in a horizontal position, both elbows should be firmly pressed against the body, and at least one elbow should be resting against the body when in a vertical position.
- 3** Hold your breath and press the shutter release button with a smooth, steady stroke. Otherwise, you will have a blurred picture.
  - When using a telephoto lens and/or slow shutter speeds below  $1/30$  sec., the use of a tripod and cable release is recommended.
  - When taking pictures against the light, always use a lens hood.
  - Camera Holder F, for attaching a tripod, and the Canon Release are separately available.



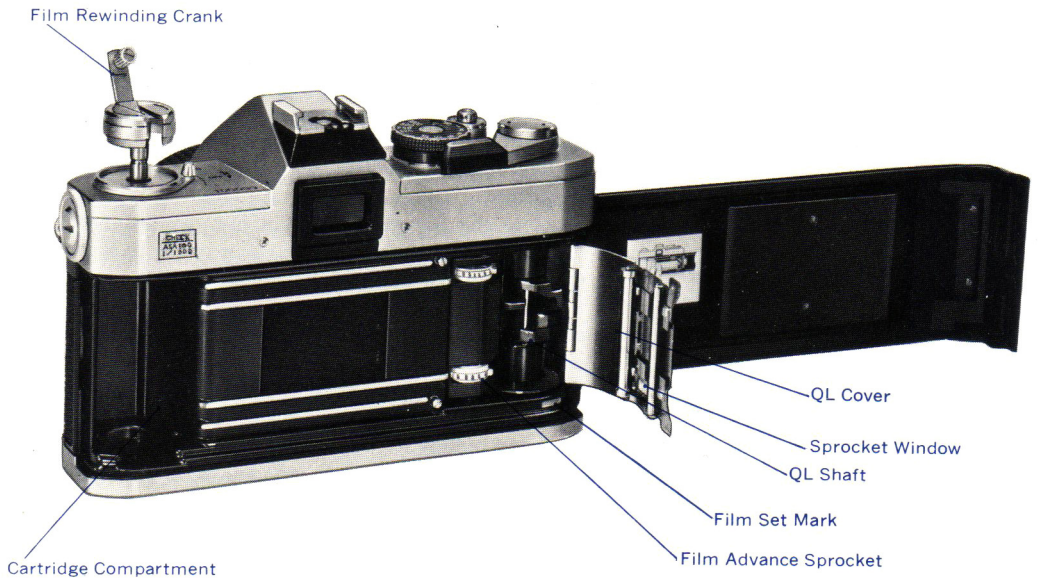

Position in which film is placed in camera  
(emulsified surface facing the back of the lens)

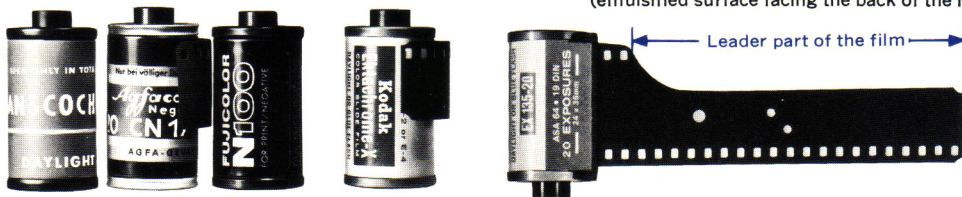

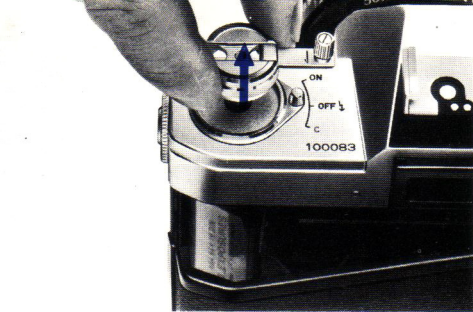

## Film Loading

The Canon FTb accepts any standard 35mm film roll in cartridge for daylight loading. Be sure not to load film in direct sunlight.

- 1 Raise the film rewind crank and pull it all the way up. The cover will rise slightly.
- 2 Open the cover fully. When the back cover is opened, the QL (Quick-Loading) cover opens simultaneously.
  - The QL cover automatically opens and closes with the back cover. Do not touch the QL cover.
- 3 Face the film cartridge as illustrated, and insert it into the cartridge compartment. Push the film rewind crank back into its former position. The crank fork will slip into the axis of the film cartridge. In case the crank does not fully return, turn it slightly to the left or right.

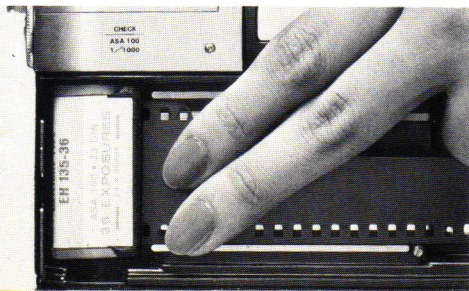
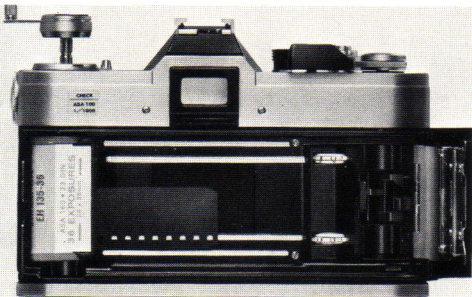

**4** Hold the film cartridge down with the left hand so that it does not rise, and lay the tip of the leader above the "red" film set mark.

**5** Bring down the QL cover to hold the film in place by closing the back cover. Look through the sprocket window to see if the film is correctly engaged on the sprocket.

**6** Press down on the back cover and close it. If the film is sagging, the cartridge will rise and the back cover will not close.

**7** Leave the lens cap on and make two blank shots, each time turning the film advance lever. The frame counter will advance from the "S" mark to "0". With one more advance, the camera will be ready for the first shot.

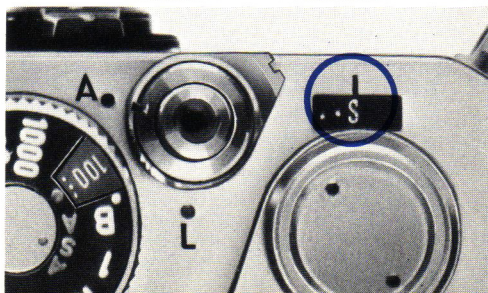
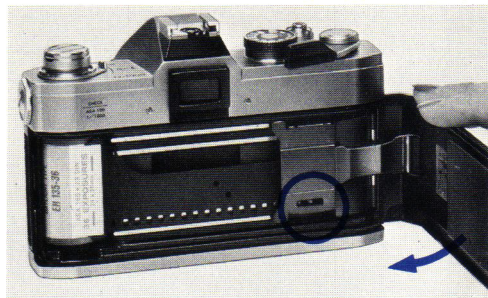
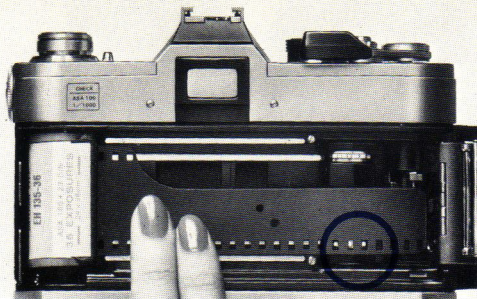



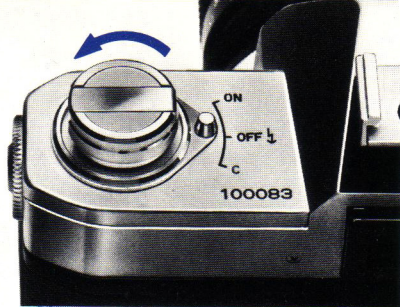

### Checking Correct Film Loading

The film is properly loaded and advanced if the film rewind crank rotates counterclockwise when you wind the film advance lever. If the film rewind crank does not rotate, take out the film, as explained on the following page, and reload.

### Setting the Film Speed

When loading the film, be sure to set the film speed scale at the proper position. Refer to page 19 for setting the film speed.

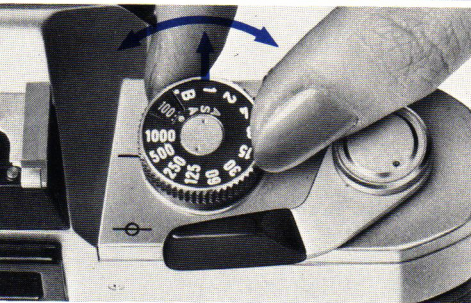

### Repacking a Long-Wound Film

When repacking a long-wound film for darkroom loading into an ordinary cartridge, be sure to trim the tip of the leader between perforations, and make a curl in the direction it winds up.

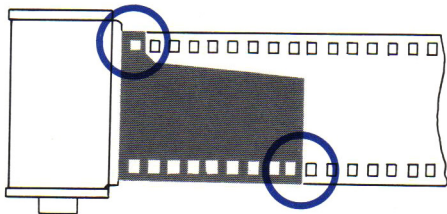

## Film Rewinding

When the film reaches the end and the film advance lever stops, rewind the film into the cartridge as soon as possible. Be sure not to open the back cover before rewinding. Otherwise, the entire roll will be exposed and ruined as the exposed film is naked within the camera.

- 1 Press in the film rewind button.
- 2 Raise the film rewind crank, turn it in the direction of the arrow, and rewind the film into the cartridge. When the film rewind button stops revolving and rewinding resistance becomes light, stop rewinding immediately in order to keep the leader part of the film outside the cartridge.
- 3 Open the back cover.
- 4 Pull up the rewind knob fully and remove the cartridge.
  - Once the film rewind button has been pressed, the finger may be removed. The button will pop out automatically when the film advance lever is wound.
  - If you force the film advance lever after the film reaches its end, the film will become detached from the cartridge spool or tear, and rewinding will become impossible. If this happens, open the back cover and remove the film only in a darkroom.

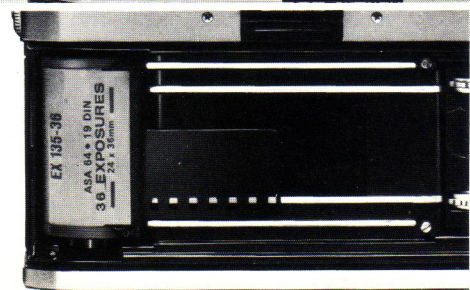



## Synchronizing Flash Unit

The Canon FTb is designed so that two systems of flash photography can be connected to it—the match needle type automatic flash photography which is called the Canon Auto-Tuning (CAT) System, using the Speedlite 133D (exclusive type), and ordinary synchronized flash photography.

Type		Synchronized Shutter Speed
Flash	FP class (#6, Press 26)	1/125 or faster 1/30 or slower
	M class (M3, #5, Press 25)	1/30 or slower
	MF class (AG-1, AG-3, M2, Flashcube)	1/30 or slower
Electronic Flash Unit	Speedlite 133D	1/60 or slower

**1** The CAT System is connected exclusively to the FD 50mm f/1.4 S.S.C., FD 50mm f/1.8 S.C., FD 35mm f/2 S.S.C. and FD 35mm f/3.5 S.C. lenses which have the flash adapter coupling pin. Attach the Flash Auto Ring A<sub>2</sub> or B<sub>2</sub> to the lens which transmits the focusing distance to the meter circuit of the camera. In the case of the CAT System, the charging power level of the Speedlite is continuously transmitted to the meter circuit of the camera. Thus,



the correct exposure can be decided as follows: Move the flash socket cover toward the arrow, and insert the cord in the flash socket. This cover serves to prevent electric shock. Set the meter switch at "OFF" and the shutter speed dial at "60". And set the distance so that the meter needle in the viewfinder moves. Then turn the preset aperture ring until the aperture needle aligns with the meter needle.

**2** When using an ordinary electronic flash unit or flash bulb unit, connect the cord of the unit to the flash socket in the camera.

To decide exposure, divide the guide number of the unit by the focusing distance and obtain the proper f/stop.

- Some tripods make the focusing ring of the FD 55mm f/1.2S.S.C. lens inoperable. In this case, attach the camera on the tripod with Canon Camera Holder F2.

- The X contact of the Canon FTb is 1/60 sec.

- A lens hood should be attached when taking pictures with a flash unit.

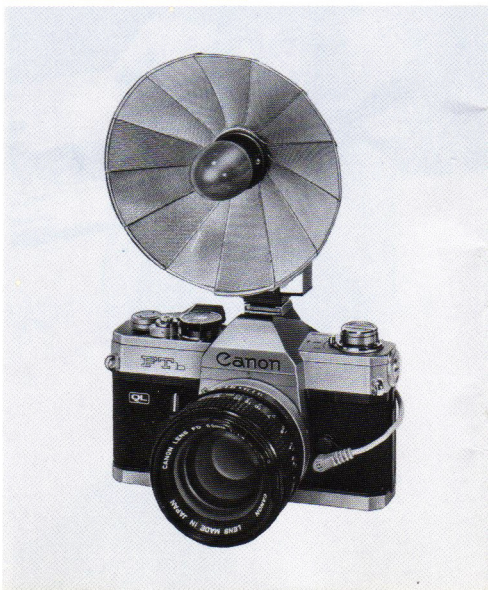
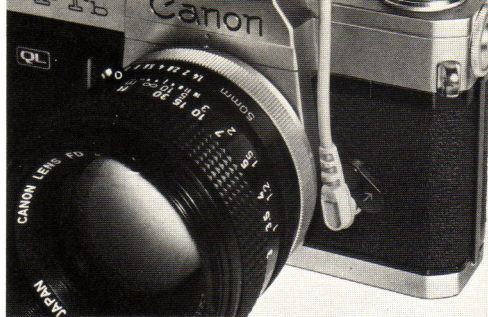

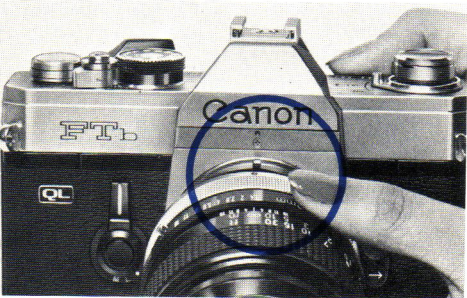

## Uses of the Lenses

### Changing Lenses

**1** Be sure to unlock the stopped-down lever lock. If the lever is pressed or is locked, the red dot appears inside the camera mount. The automatic/manual aperture lever, at the back end of the lens, cannot be connected to the coupling part on the camera body and the preset aperture will not function.

- To remove the dust cap of the lens, turn the breech-lock mount ring fully to the left. In this case, mount the lens on the camera body as is.

**2** Remove the lens from the camera body by turning the breech-lock mount ring of the lens to the left until the red dot on the lens coincides with the red dot on the camera mount.

**3** To confirm the operation or for reverse-lens shooting, first remove the lens from the camera body. Then, use a pointed object to press the lock pin which is located just above the positioning pin of the breech-lock mount ring and turn the breech-lock ring.

- When the preset aperture ring is set at the green mark (circle), the lens cannot be attached to the FTb body.

**4** Mount the lens by matching the red dot of the lens to the red dot on the camera mount. Turn the breech-lock mount ring to the right and fasten:

- Attach the lens quickly in the shade. The film will sometimes become foggy if the lens is left unattached.

■ Whenever a lens is removed, be sure to put on the dust cap to protect the various signal levers and pins. When not in use for a long time, protect the mirror with a flange cap.

## Lens Signal

**Aperture Signal Lever:** Transmits the preset f/stop of the automatic aperture to the camera body. It is on a 1 to 1 movement basis with the preset aperture through lever manipulation. The aperture signal lever can be operated only when the breech-lock mount ring is turned to the attaching position.

**Full Aperture Signal Pin:** Transmits the full aperture stop when a lens with a different full aperture number is mounted. It also performs error compensation in full aperture metering.

**Automatic/Manual Aperture Lever:** Stops down the aperture to the preset position. Clamp it to the right side for manual aperture operation.

**EE Lock Pin:** This is a protective pin to prevent the aperture of the lens from moving to the green mark unintentionally. In order to set it at the green mark, turn the aperture ring while pushing down the EE lock pin. When withdrawing it from the green mark, turn the aperture ring again while pushing down the EE lock pin.

**EE Switch Pin:** When the preset aperture ring is set at the green mark for EE use, the lens can be attached only to the Canon F-1. If the lens is attached to the FTb, it cannot be set at the green mark.

**Pin:** Reserved.

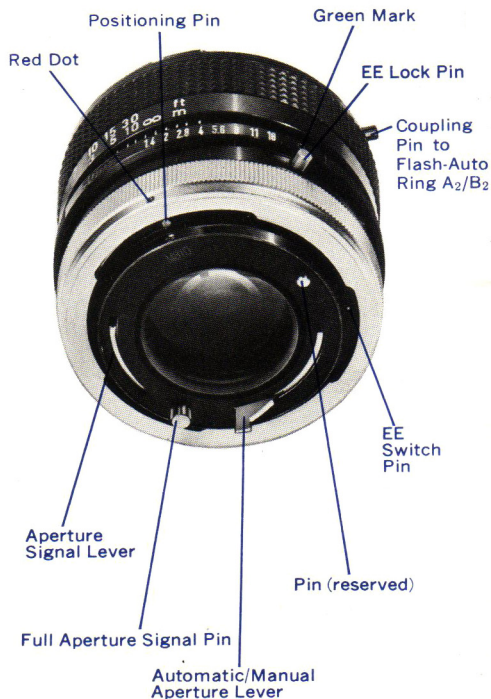



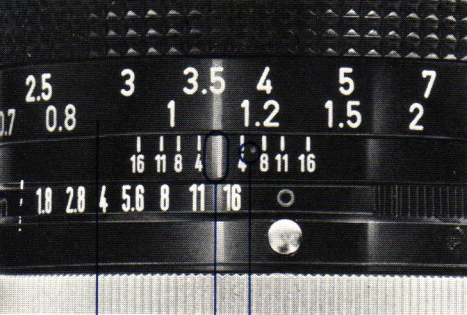

Distance Scale

Infrared Index  
(red dot)

Index (orange line)

## Distance Scale

The distance scale indicates the distance between the focused subject and the film plane. The scale is necessary for checking the depth of field, for flash and infrared photographs.

- The correct position of the scale is in the center of each value. For example, the correct position of a two-digit value is the center of the two figures.

## Infrared Index

For infrared photography, correction of the distance scale is necessary because the focal point slightly deviates from ordinary photography. Focus first in the ordinary manner, then adjust the distance scale to the infrared mark “. ” (“R” in the case of FL lenses) in red. For instance, if the distance scale reads 10m after focusing, merely shift the 10 scale to “. ” position. The position of “. ” on the FTb is based on using film with the highest wave-length sensitivity figure of 800m $\mu$ , such as the Kodak IR 135 film and the Wratten 87 filter.

## Film Plane Indicator

When focusing is done by actual measurement, measure the distance from the film plane indicator and interpret the measured distance on the distance scale.

When performing close-ups, macrophotography or copy work, decide the distance of the camera from the subject with this indicator.

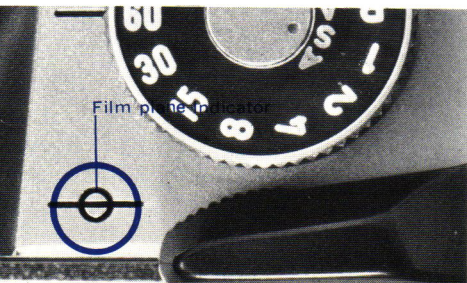

Film plane indicator

## Depth of Field Scale

The depth of field scale indicates the range of subjects which will be in sharp focus on the film. In this case, the depth of field behind the subject is deeper than in front of subject. This range will vary with the following factors: The depth of field will be deeper, the larger the f/stop number, the further the distance of the subject, and/or the shorter the focal length of the lens. The depth of field will be shallower, the smaller the f/stop number, the nearer the distance of the subject, and/or the longer the focal length of the lens.

For example, if the lens is 50mm and the subject has been focused at a distance of 3m (10'), with an f/8 aperture opening read off from both indexes on either side of the indicator (orange line), the approximate depth of field is from 2.3m (8') to 4.3m (14').

If the aperture is closed down to f/16, the picture will become sharp when the subject is between 1.9m (6') to 7.6m (25') from the camera. This range will vary with the selected f/stop.

- When using Canon's FD lenses, you can see the actual sharpness through the viewfinder by pressing the stopped-down functioning lever.
- Although air bubbles may sometimes be seen in a lens, they do not affect the resolving power or the sharpness of the picture.

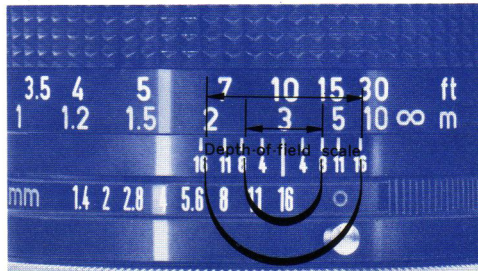
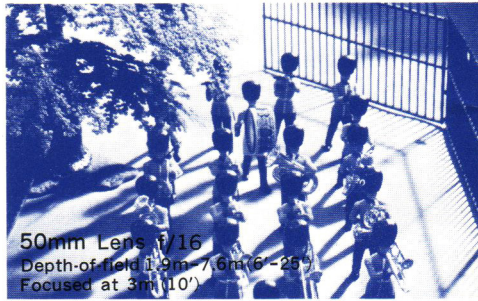



## Lens Hood

When attaching the lens hood on the lens, align it to the bayonet ring on the lens and turn it clockwise.

With some exceptions of standard and wide angle lenses, a lens hood can be stored in the camera case. When doing this, attach the lens hood onto the lens in inversed order and align it to the bayonet ring and turn counterclockwise.



## FD Lens Mount (FL and R Series Lenses)

All Canon FD and FL lenses, which have FD and FL mounts, can be used with the Canon FTb, except the FLP 38mm f/2.8.

■ It is also possible to attach and use all Canon R lenses for the Canonflex. However, as the preset aperture mechanism differs, pictures must be taken by controlling the aperture manually.



## Fixing Mirror Upwards

In performing photomicrography, the Canon FTb can be operated with the mirror locked in an upward position after the picture has been composed in the viewfinder, in order to eliminate mirror vibration.

To lock the mirror in an upward position, push down the stopped-down lever and the lever lock to "M".

The aperture is now stopped-down and controlled manually. The mirror can be locked independently from film advance and shutter speed operations.

When the mirror is locked in an upward position, SLR viewing is not possible, and distance must be estimated by eye. When the mirror is locked, always keep the lens covered. The film will sometimes become foggy if the lens cap is not attached.

■ After the mirror lock device has been used, be sure to return the mirror lock lever to its original position. Failure to do this will result in inaccurate focusing.

■ When Canon Lens FL 19mm f/3.5 is used, the mirror should be fixed, and combined use of this lens' exclusive viewfinder becomes necessary.



## Using Self-Timer



- 1 Wind the film advance lever.
- 2 Turn the self-timer lever counterclockwise all the way down until it stops.
- 3 Depress the shutter release button. The shutter will be activated approximately 10 seconds later.
  - Be sure to wind the film advance lever. Otherwise, the self-timer will act but the shutter will not be activated.
  - The self-timer lever can be used as a stopped-down functioning lever as soon as the self-timer is charged.
  - If the self-timer lever is set while the mirror is in an upward position, the mirror-up position is released. Therefore, always set the mirror in an upward position after setting the self-timer.

## Double Exposures

Although the Canon FTb is designed to prevent double exposures being made by mistake, a double exposure can be made by the following steps:

- 1** When the first exposure has been made, depress the film rewind button.
- 2** Rewind the film with the film rewind crank while watching the mark on the film rewind button carefully.
- 3** Stop rewinding when the mark has made a  $7/8$  turn, i.e.,  $315^\circ$ .
- 4** Next, wind the film advance lever while lightly holding the rewinding crank. When resistance is felt on the film rewind crank, stop winding.
- 5** Wind the film advance lever once more. The camera is ready for another exposure.
  - By repeating the above process, any number of exposures on the same frame can be made. However the frame counter will continue to advance with each exposure.

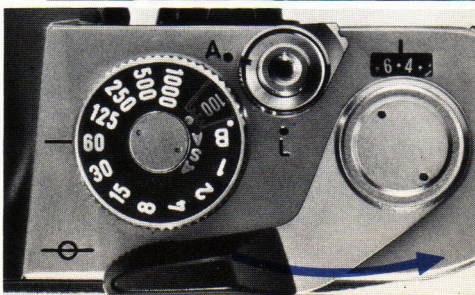
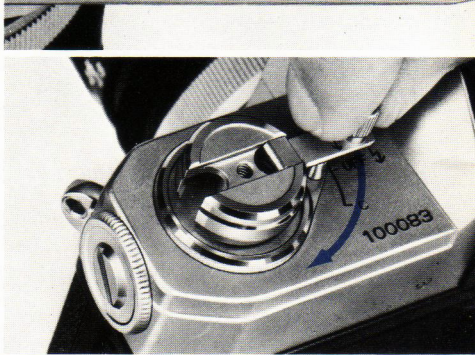



## Filters



Various types of filters, according to lens thread diameters, are available for special effects in both color and monochrome photographs. The through-the-lens exposure measurement system of the Canon FTb does not require exposure factor compensation.

Type	Effectiveness of Filters
○● UV	Absorbs only ultra-violet rays. Especially effective at seaside, and in high mountains. Recommended for use in color photography.
○ Y1 Y3	Increases contrast of black and white film. Enhances clouds, darkens the blue sky. Brightens red and yellow.
○ O1	Darkens blue, increases yellow and red perceptibly. Good for contrasts especially in distant landscapes.
○ R1	Makes strong contrasts. May also be used with infrared film.
○ G1	Prevents red from turning radically into white. Lightens sky and face appropriately, and reflects the lightness of fresh greenery.
○● ND4 ND8	ND4 reduces light values by 1/4, ND8 by 1/8. No effect on the reproduction of colors.
● SKYLIGHT	Acts to harmonize the blue sky and shade.
● CCA4	For use with daylight type film under cloudy conditions.
● CCA8	For use with universal type (color negative) film under cloudy conditions or with tungsten type film in the morning sun or sunset.
● CCA (12)	For use with tungsten type film under sunlight.
● CCB4	For use with daylight type film in the morning sun or sunset.
● CCB8	For use with daylight type film and clear flash bulb.
● CCB (12)	For use with daylight type film under tungsten light.

○ For black and white film. ● For color film.

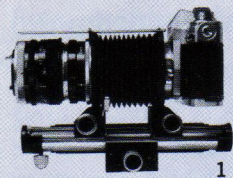

1

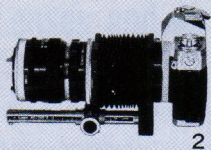

2



3



4



5

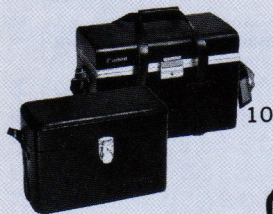

9

10



6

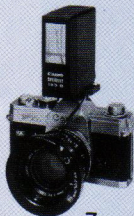

7



8



11



12



17



15



16



13



14



18



19



20



21







22



23



24

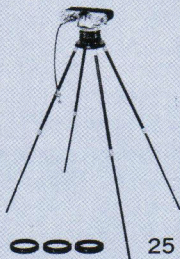

25



26



27

## Accessories

1. Bellows FL
2. Bellows M
3. Angle Finder A2, B
4. Magnifier S and Magnifier Adapter S
5. Dioptic Adjustment Lenses (S type)
6. Flash V-3
7. Speedlite 133D/Flash-Auto Ring A2/B2
8. Camera Holder F2
9. Gadget Bag 4
10. Gadget Bag G-1
11. Neck Strap 4
12. Filter 55mm/58mm
13. 55mm Close-up Lens 240, 450
14. 58mm Close-up Lens 240, 450, 1800
15. Lens Hood BW-55-A, BW-55-B, BS-55, BT-55, BS-58
16. Lens Cap C 55, C 58
17. Canon Release 30, 50
18. Extension Tubes M 5,10,20
19. Macrophoto Coupler FL 55, 58
20. Copy Stand 4
21. Lens Mount Converter A, B
22. Slide Duplicator
23. Microphoto Hood
24. Photomicro Unit F
25. Handy Stand F
26. FTb Case 1.4, 1.2
27. SLR Eyecup 4S



Stopped-Down Metering/Self-Timer Lever

Lever Lock/Mirror Lock Lever

Aperture Signal Coupling Lever

Stopped-Down Coupling Lever

Lens Speed Adjustment Pin

Flash Socket Cover

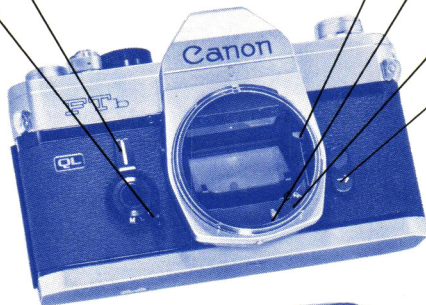

Battery Compartment

Back Cover

Film Rewind Button

Dioptric Adjustment  
Attachment Groove

Tripod Socket

Viewfinder Eyepiece

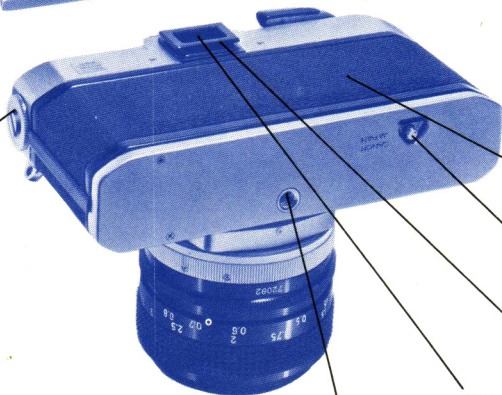

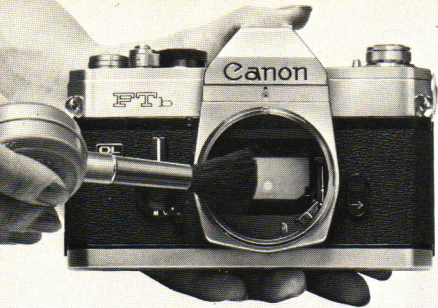

## Proper Care of the Camera

Moisture and dust are harmful to your camera. If your camera is to be stored for a long time, it should be removed from its case and also remove the mercury battery, and silica gel or another drying agent should be placed alongside it.

When you use your camera on a rainy day, or at the beach, moisture and salt air adhere to it, which can result in stains, rust, and corrosion. Use a soft brush to get rid of dust and a soft dry cloth for wiping.

- In extremely cold areas, expose the camera to the outer air only when in use. When using, expose the camera gradually to the outer air to prevent the lens from clouding.

- Do not keep the camera in a hot place such as a globe compartment or the rear window shelf. It will cause trouble with the camera.

- Do not expose the camera leaving it without the lens cap directly to the sun. It will cause a fog on the film and a pin-hole on the shutter curtain.

- If the camera will not be used for an extended length of time, the battery should be taken out of the battery compartment to prevent possible damage to the terminals from battery corrosion.

### Cleaning the Lens

Use a blower or a brush to remove dust on the lens. If you should get a fingerprint on the lens, soak a little pure alcohol or ether on lens cleaning tissue. Then wrap the tissue around a matchstick and wipe the lens lightly in a circular motion.

Camera Body Number \_\_\_\_\_

Lens Number \_\_\_\_\_

Date of Purchase \_\_\_\_\_

Dealer's Name \_\_\_\_\_

# Canon

**CANON INC.** 11-28, Mita 3-chome, Minato-ku, Tokyo 108, Japan

- U.S.A. ————— **CANON U.S.A., INC. HEAD OFFICE**  
10 Nevada Drive, Lake Success, Long Island, N.Y. 11040, U.S.A.  
**CANON U.S.A., INC. MANHATTAN OFFICE**  
600 Third Avenue, New York, N.Y. 10016, U.S.A.  
**CANON U.S.A., INC. CHICAGO OFFICE**  
457 Fullerton Avenue, Elmhurst, Illinois 60126, U.S.A.  
**CANON U.S.A., INC. LOS ANGELES OFFICE**  
123 Paularino Avenue East, Costa Mesa, California 92626, U.S.A.  
**CANON U.S.A., INC. WILSHIRE OFFICE**  
3113 Wilshire Boulevard, Los Angeles, California 90010, U.S.A.
- CANADA ————— **CANON OPTICS & BUSINESS MACHINES CANADA, LTD.**  
**HEAD OFFICE**  
3245 American Drive, Mississauga, Ontario, L4V 1B8, Canada  
**CANON OPTICS & BUSINESS MACHINES CANADA, LTD.**  
**MONTREAL OFFICE**  
3070 Brabant-Marineau Street, St. Laurent, Quebec, H4S 1K7, Canada
- EUROPE, AFRICA  
& MIDDLE EAST ————— **CANON AMSTERDAM N.V.**  
Gebouw 70, Schiphol Oost, Holland
- CENTRAL &  
SOUTH AMERICA ————— **CANON LATIN AMERICA, INC. SALES DEPARTMENT**  
P. O. Box 7022, Panama 5, Rep. of Panama  
**CANON LATIN AMERICA, INC. REPAIR SERVICE CENTER**  
P. O. Box 2019, Colon Free Zone, Rep. of Panama
- SOUTHEAST ASIA ————— **CANON INC. HONG KONG BRANCH**  
5th Floor 2-6, Fui Yiu Kok Street, Tsuen Wan, New Territories, Hong Kong