

WILSONWERKS ARCHIVES

This camera manual is for reference and historical purposes, all rights reserved.

This cover page is copyrighted material. This document may not be sold or distributed without the express consent of the publisher.

©2008 wilsonwerks Llc

INSTRUCTIONS
PART
I

INTRODUCTION TO THE
Canon AE-1

The Basic Steps to Picture-Taking



What's all this? Warranty, instructions . . . We don't need all this stuff. I'm going to throw it away.



Hey! Wait a minute. . .



Well, look here. This warranty card says that it doesn't cover any mishandling of the camera by the user. Besides, we know next to nothing about a camera like this. I think maybe we should look into these instructions.

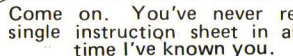

Come on. You've never read a single instruction sheet in all the time I've known you.



Okay. They're pretty short. I guess it won't take us very long.

E

Congratulations on your purchase of a Canon AE-1. We know that you are anxious to start taking pictures with it. Our first hint for taking great ones is to read these instructions. Follow the steps in order and become well acquainted with the camera. Then, once you have a good understanding of PART I, move on to PART II. It contains a lot of information you won't find elsewhere. The brief time spent in reading these instructions is a sound investment in satisfaction and enjoyment.

Symbols



Signals an important DO.



Signals an important DON'T.

Copyright © 1980 by Canon Inc.

All rights reserved.

Printed in Japan

CONTENTS

1. Attach the lens pp.3-4
2. Set the lens for AE photography p.5
3. Load the battery p.6
4. Check the battery p.7
5. Before loading film, learn to operate
basic controls p.8
6. Set the ASA p.9
7. Load the film pp.10-12
8. Learn to hold the camera correctly p.13
9. One shot at a time pp.14-15
10. At the end of the roll, rewind
the film p.16
- * Dedicated Flash Photography p.17
- * Self-Timer pp.18-19
- * Carrying the Camera p.20
- * Pre-Shooting Checklist p.21

Camera parts are labeled on the insides of the foldout flaps at the beginning and end of PART II.

1. Attach the Lens

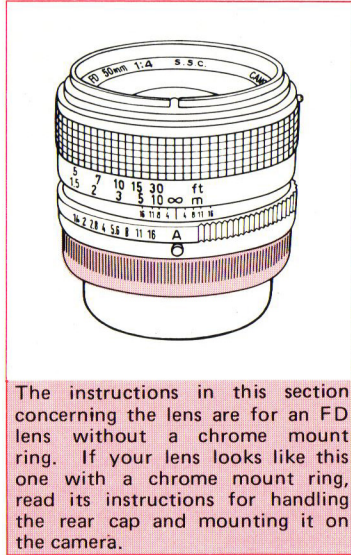

The instructions in this section concerning the lens are for an FD lens without a chrome mount ring. If your lens looks like this one with a chrome mount ring, read its instructions for handling the rear cap and mounting it on the camera.

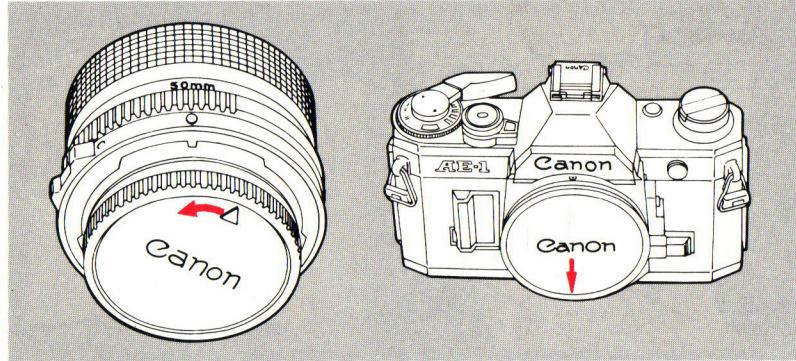

Remove the rear lens cap by turning it in the direction of the arrow until it stops and pulling it out.

Remove the body cap.

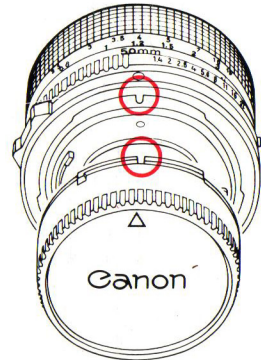

To reattach the rear lens cap, align it with the lens as illustrated. Then lightly push it in and turn it clockwise until it stops.

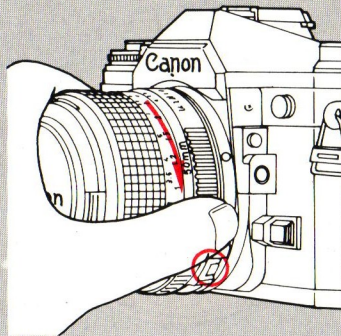
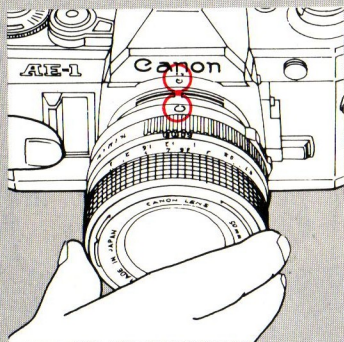



Make sure the lens release button has popped out. Otherwise, the lens will not work properly. **DO NOT** press the lens release button while mounting or it will not pop out.

To mount the lens, first align the rounded red positioning point on the lens with the red dot above the camera mount as illustrated.

Then turn the lens in the direction of the arrow until it stops and the lens release button pops out with a click.

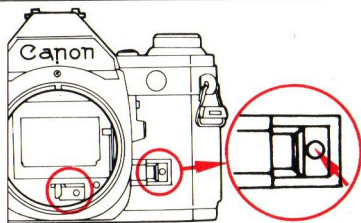
 If your camera looks like this, with a red dot showing inside the camera mount, do not mount the lens yet. First press in the small chrome button as shown to release the stop-down slide. Then mount the lens. Leave the stop-down slide as it is.



 When film is loaded, make sure it is completely advanced to the next frame before mounting the lens.

2. Set the Lens for AE (Automatic Exposure) Photography

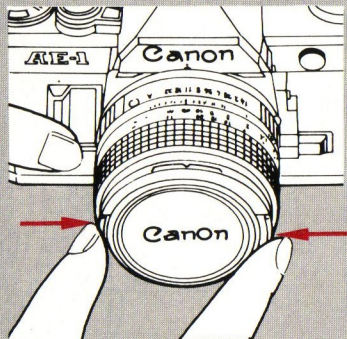

Remove the front lens cap.

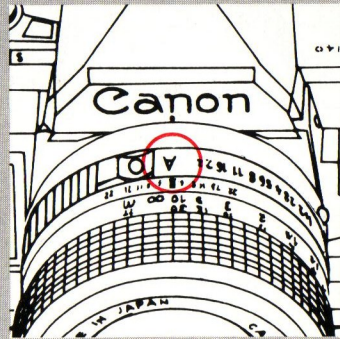
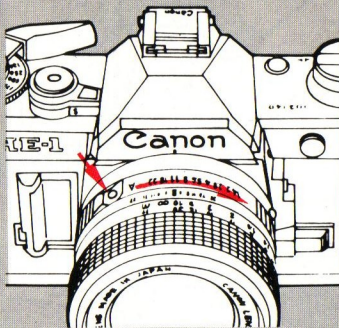

While pressing in the EE lock pin, turn the aperture ring in the direction of the arrow until "A" click-stops at the aperture index. "A" will be in line with the red dot on the camera. If you forget to do this, automatic exposure will be impossible.

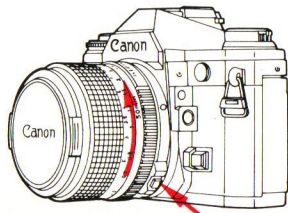

To remove the lens, turn it in the direction of the arrow, while pressing the lens release button, until it stops.

Notes

1. AE photography is possible only with a Canon FD lens. See PART II, p.24 for how to use a non-FD lens on the AE-1.
2. Some Canon FD lenses have a green circle in place of the "A" mark. It means the same thing as the "A" mark.

3. Load the Battery

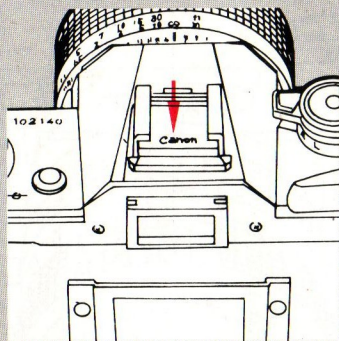

Remove the viewfinder cover from the accessory shoe.

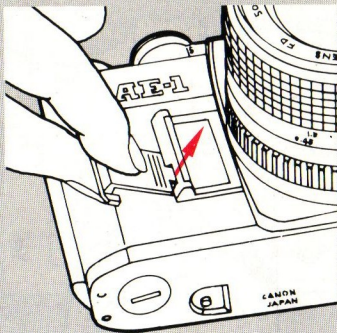

Open the battery chamber cover using the viewfinder cover.

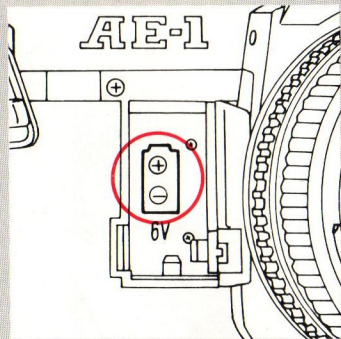

Load one new battery so that its poles are in the directions indicated by the diagram inside the battery chamber.

Correct Batteries	Examples
Silver Oxide 6V	Eveready (UCAR) No.544, Mallory PX 28, JIS 4G13
Alkaline-manganese 6V	Eveready (UCAR) No.537

Without a battery, the AE-1's shutter will not work and it will be impossible to take a picture. We recommend carrying a spare battery.

4. Check the Battery

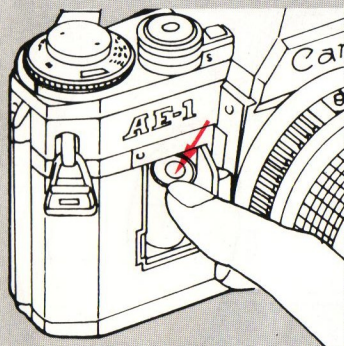

Insert the negative end first. Then push down and insert the positive end. Close the chamber cover.

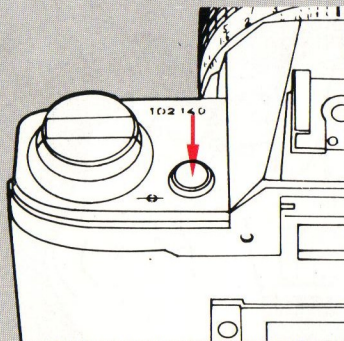

Press the battery check button while looking through the viewfinder. The meter needle in the viewfinder will move.

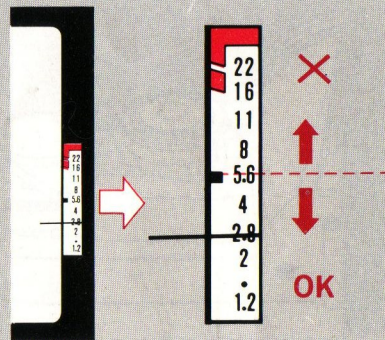

If the battery is good, the meter needle will rest at or below the battery check index. If there is not enough power, it will rest above the index. Replace the battery.

⊗ Don't touch the battery poles. Wipe them and the camera contacts with a clean, dry cloth before loading to prevent poor contact from dirt.



Notes

1. With normal use, the battery should last about one year.
2. It is necessary to take special precautions with the battery when you are shooting in very low temperatures (below 0°C, 32°F). See PART II, p.30.

5. Before Loading Film, Learn to Operate Basic Controls

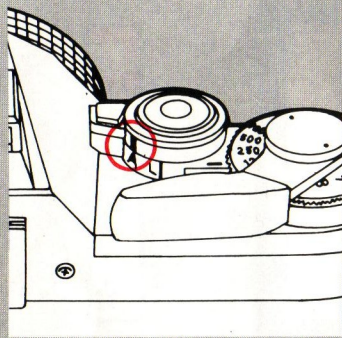

Turn the shutter button lock lever to "A".

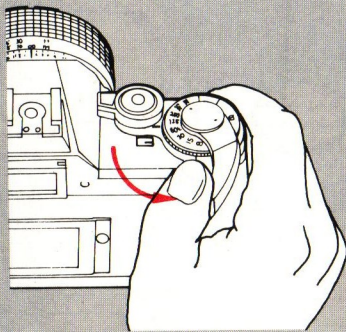

Turn the film advance lever in the direction of the arrow until it stops. You may turn it in one continuous stroke or in several short strokes. When film is loaded, this will advance it to the next frame.

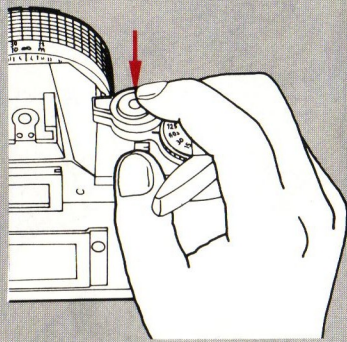

The AE-1 has a two-step shutter button. Press it half-way to turn the meter on and to get a meter reading in the viewfinder. Gently squeeze it all the way down to release the shutter. You cannot release the shutter again until the film is advanced.

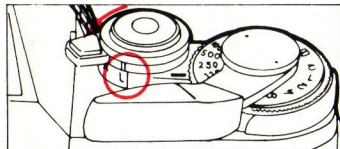

- ✓ Turn the shutter button lock lever to "L" to prevent accidental shutter release or battery drain whenever you are not using the camera.

⊗ NEVER JAB the shutter button! Pressing it gently is important for getting sharp pictures.

6. Set the ASA

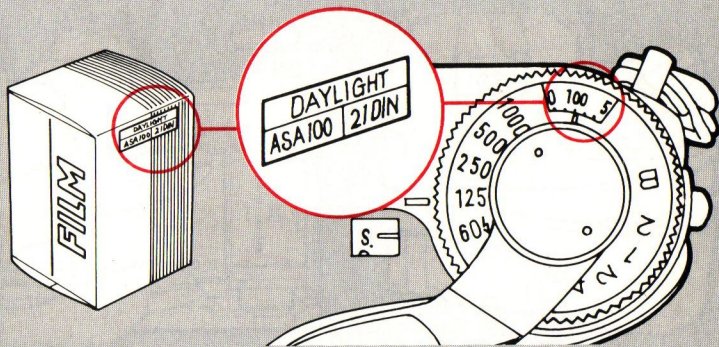
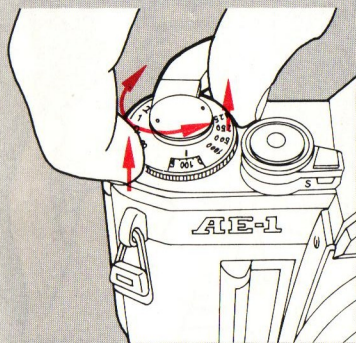

Lift the knurled ring around the shutter speed dial and turn it until the ASA speed of your film is aligned with the green index. This is absolutely necessary for getting correct exposure.

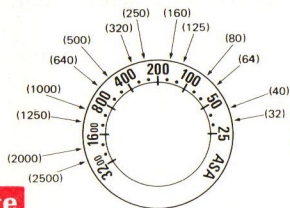

Note

If the shutter speed dial turns while you are setting the ASA, turn it to "B" or "1000" and then set the ASA.

Have you figured out what this slot on the camera's back is for?

The top of the film carton fits in there. That way we can remember what kind of film is loaded. What a convenient memo holder!



7. Load the Film

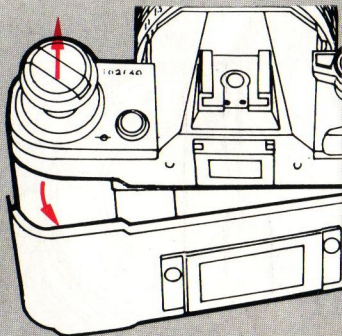

Pull the rewind knob up until the back cover pops open.

A plastic insert is attached to the pressure plate of a new AE-1 to protect it in transport. Before loading the first film cartridge, it is important to remove this insert. It may be thrown away.

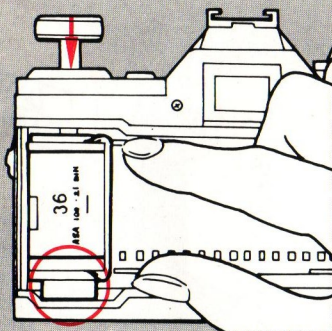
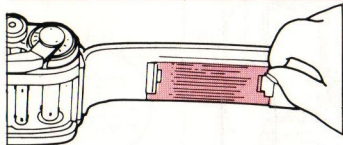

The AE-1 uses color (negative or slide) or black and white film in standard 35mm cartridges. Place the cartridge in the film chamber as shown. Then push the rewind knob down, rotating it until it drops into its normal position.

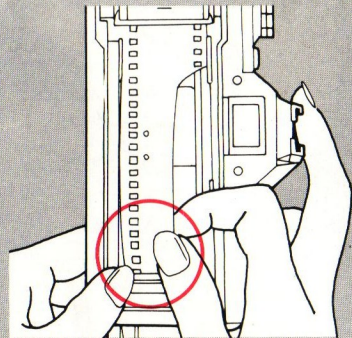

Pull the film leader across the camera and insert it into any slot of the take-up spool.

Shield the film from direct sunlight while loading.

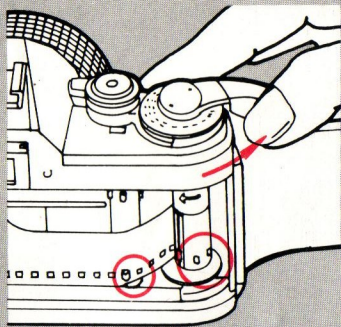

Advance the film once. Check that the film perforations are engaged in the teeth of the film transport sprocket and the take-up spool.

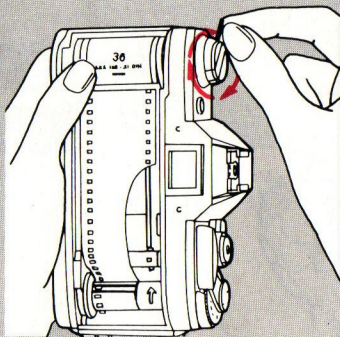

The film should be taut. If there is slack, gently turn the rewind crank in the direction of the arrow until it stops. Close the back cover.

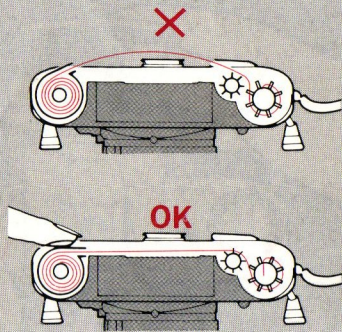

⊗ While loading the film, take care not to touch the shutter curtain, the film rails or the pressure plate (parts in red).

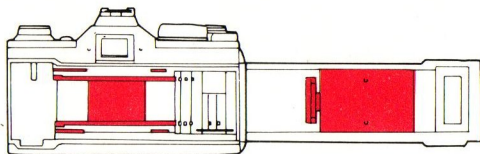

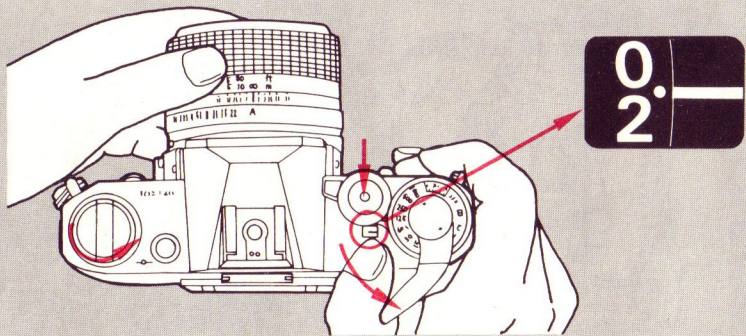

Take several blank shots, releasing the shutter and advancing the film, until the frame counter reads "1" (the dot following zero). While doing this, keep an eye on the rewind knob. If it rotates in the direction of the arrow, the film is loaded correctly.

Each time you advance the film, the frame counter also advances to the next frame. It can count up to 38 frames. The numbers 20 and 36 are in orange to call your attention to the fact that rolls with those numbers of frames are or are almost finished.

8. Learn to Hold the Camera Correctly



The slightest movement of your body during shutter release may cause blur in the picture. To reduce chances of this, hold the camera as steady as possible with your left hand supporting the camera and lens. Press both elbows to your body and lightly press the camera to your cheek or forehead. For a vertical shot, steady at least one elbow against your body. Spread your feet slightly apart, one foot ahead of the other, and relax. If a wall or a tree is available, lean against it.

Note

There is, of course, no one correct way to hold the camera. Experiment to find the most comfortable way for you of holding it steady. It may help to practice in front of a mirror.

9. One Shot at a Time

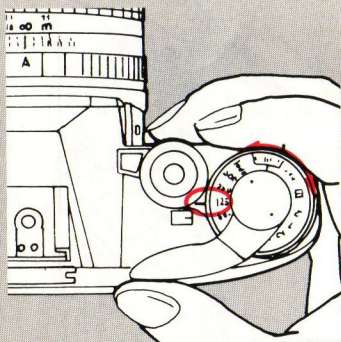

Set a shutter speed by turning the shutter speed dial until a number from 60 to 1000 is aligned with the index.



Then look into the viewfinder and press the shutter button HALFWAY. The meter needle will move to tell you whether the shutter speed you have set will give correct exposure.

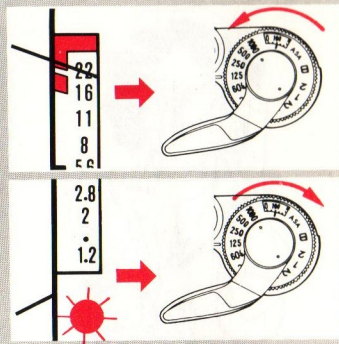

If the meter needle points to the red zone at the top of the scale or if the red LED (Light-Emitting Diode) blinks below the scale, turn the shutter speed dial as shown. Otherwise, exposure will be correct at the shutter speed you have set.

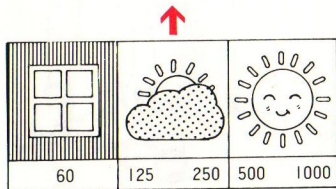

- ⊗ Do not set the shutter speed dial between the click-stop settings. Note that it does not turn past "1000" or "B".

Note

See PART II, p.14, if you must set the shutter speed dial to a number below "60". If action is a particularly important element in the shot, you may wish to refer to PART II, p.13, for more information on choosing a shutter speed.

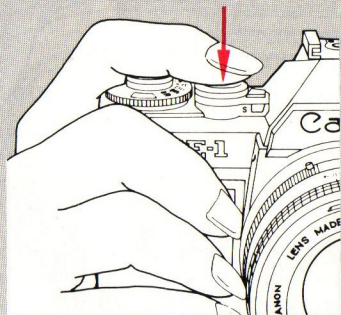
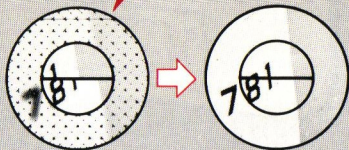

Compose the picture. Center your subject in the viewfinder if possible. Turn the focusing ring until the main subject is sharp.

Press the shutter button all the way down to take the picture.

What do you think this thing is for?

Must be Eyecup 4S. I tried attaching it to the eyepiece and it made viewing lots more comfortable.



Note

If there is light, such as the sun or a window, behind your subject, press the backlight control switch as you press the shutter button. See PART II, p.20.

10. At the End of the Roll, Rewind the Film

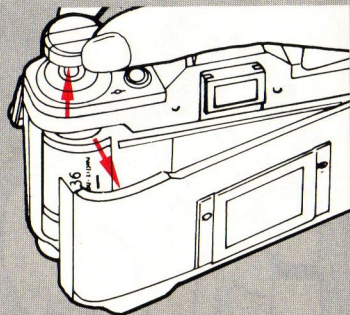
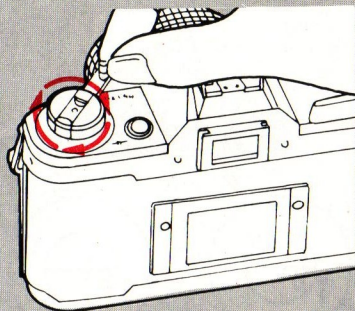
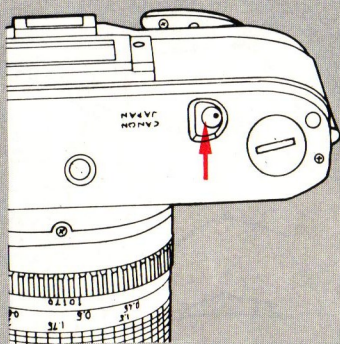

You can tell you have reached the end of the film by the frame counter and the film advance lever. Either the film advance lever will not turn at all or it will not turn all the way. First press in the rewind button. You may immediately let go of it.

Then turn the rewind crank in the direction of the arrow until the frame counter, which counts backwards as you rewind, reaches "S".

Then open the back cover, remove the film cartridge, place it back in its canister and have it developed as soon as possible.

⊗ DO NOT open the back cover until you have rewound the film back into the cartridge. If you do, light falling on the film may ruin all of the pictures.

Note

The rewind button rotates as you rewind the film. When the film is completely rewound, it stops rotating.

* Dedicated Flash Photography

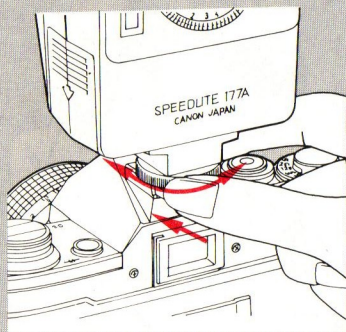

Load the flash with batteries and slide it into the AE-1's accessory shoe. Tighten the lock nut.

Note

Canon offers four Speedlites (133A, 155A, 177A, 199A) for the AE-1. With slight differences, all four are used in almost the same way. See PART II, p.33, and the Speedlite's instructions for more details.

- ✓ Make sure the AE-1's shutter speed dial is not on "B". Any other setting is okay.

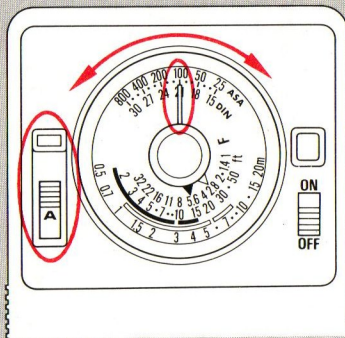

Turn the Speedlite's ASA film speed dial to the correct ASA speed and push the aperture selection switch to the green or red "A" position.

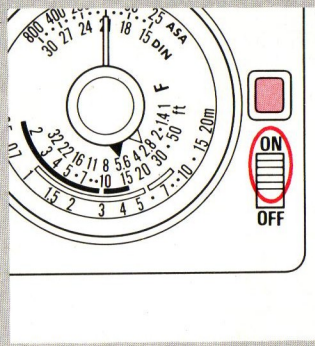

Turn the Speedlite's main switch ON. After the pilot lamp glows, press the shutter button to take the picture.

- ✓ For correct exposure, the subject must be within a certain range of distances from the camera. The required distance range is shown on the flash by the curve which is the same color as the setting of the aperture selection switch. After you focus, check the lens' distance scale to make sure the focused distance is within the range shown by the curve.
- ⊗ Do not shoot before the pilot lamp glows or exposure may be incorrect.

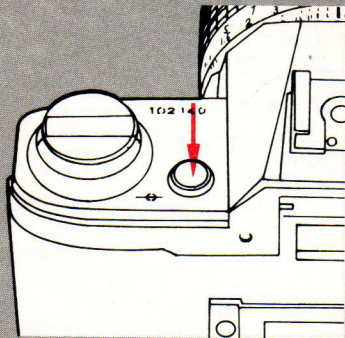

If you have started the self-timer and wish to cancel it before shutter release, press the battery check button.

Oh, no! I already started the self-timer and I wanted to stop it so I just pushed the lever back in, but as soon as I did that, the shutter released.



You're going to have a great picture of an empty chair! Try pressing the battery check button next time.

*Carrying the Camera

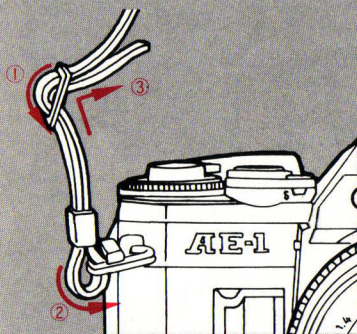

Thread the ends of the strap through the rings on the camera as shown.

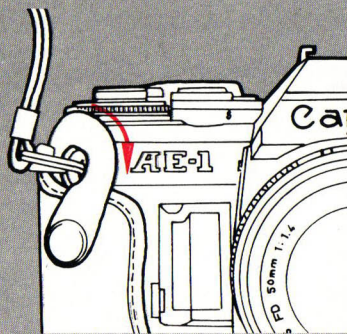

For carrying the camera, in particular, insert it into its semi-hard case (optional accessory) as shown. You can still take a picture while the camera is in the case by turning the top cover down.

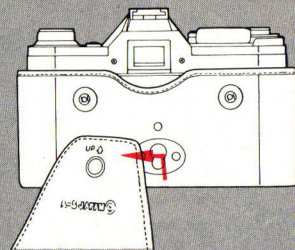

To remove the top cover, turn it down, then push it straight up and out. Turn the lens' focusing ring to infinity (∞) for closing the top cover.

Notes

1. Do not forget to turn the shutter button lock lever to "L" to prevent accidental shutter release while carrying the camera.
2. The camera case must be removed for loading and rewinding film.

*Pre-Shooting Checklist

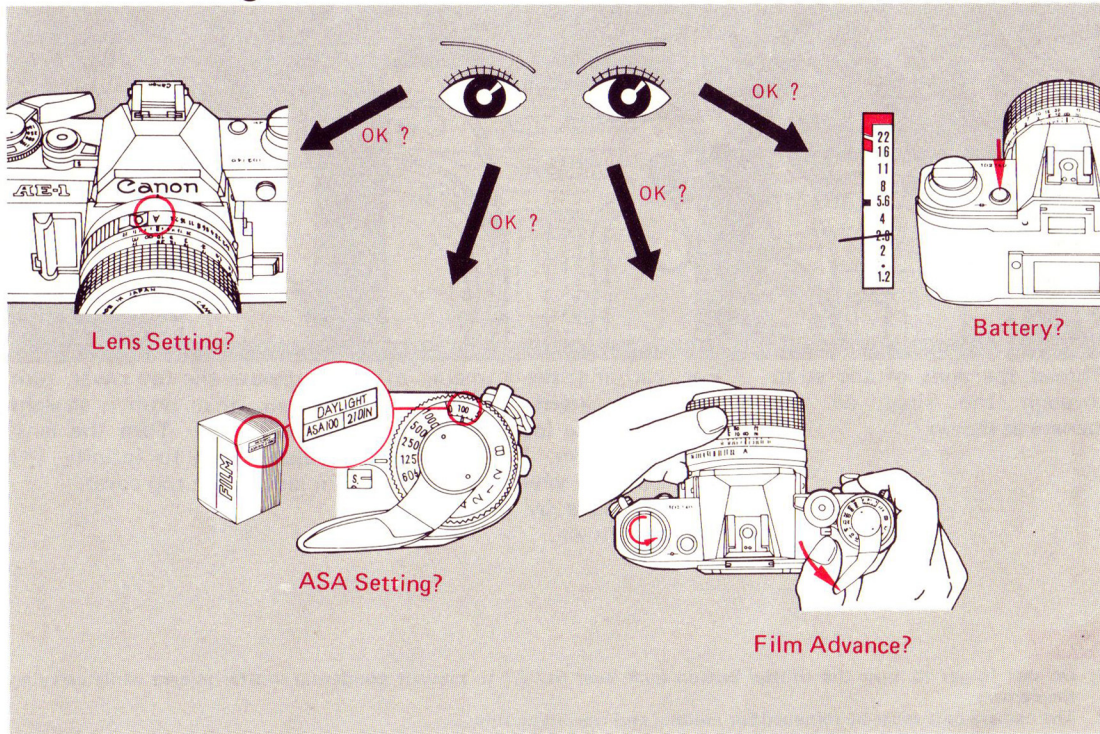

Hey, look at this. Our first roll — all great shots! Did you have to take one of me with my hair up in rollers?

What about this one of me falling off the pier? Hey, where's Part II of the instructions? I'm ready for more.



Canon

INSTRUCTIONS

**PART
II**

Canon AE-1

OWNER'S MANUAL

Fundamentals

Precautions

Hints

Special Shooting Conditions

Special Functions



E



PARTS

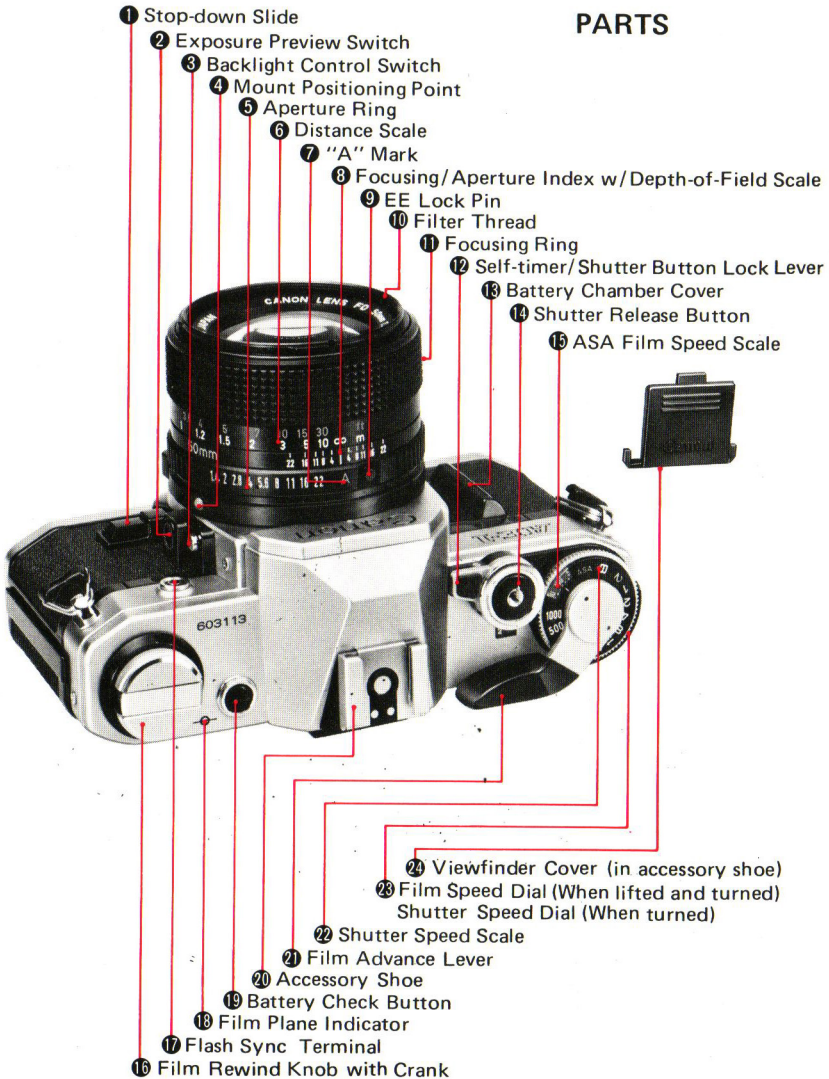

Now that you have read PART I, shot a roll or two of film and seen how easy it is to take good pictures with the AE-1, you are ready for this part. It contains the kind of information which makes picture-taking such a rewarding experience.

Copyright © 1980 by Canon Inc.

All rights reserved.

Printed in Japan

HAVE YOU READ PART I?

CONTENTS

IMPORTANT TECHNICAL INFORMATION

ABOUT PART I	p. 6
EXPOSURE	p.11
HOW TO CHOOSE A SHUTTER SPEED	p.12
SHOOTING AT SHUTTER SPEEDS SLOWER THAN 1/60 SEC. OR WITH A TELEPHOTO LENS	p.14
APERTURE, EXPOSURE'S OTHER HALF: WHAT IT IS AND HOW IT AFFECTS THE PICTURE	p.16
CHECKING THE DEPTH OF FIELD	p.18
SHOOTING WITH LIGHT BEHIND YOUR SUBJECT (AND OTHER UNUSUAL LIGHTING SITUATIONS)	p.20
SHOOTING AT NIGHT	p.23
SHOOTING WITH A NON-FD LENS	p.24
SHOOTING WITH CLOSE-UP ACCESSORIES	p.26
FLASH PHOTOGRAPHY	p.28
SHOOTING WITH INFRARED FILM	p.30
SHOOTING IN VERY LOW TEMPERATURES	p.30
OPTIONAL ACCESSORIES	p.32
CARE OF THE CAMERA	p.37
SPECIFICATIONS	p.38
INDEX	p.40

If you are looking for the function of a certain part of the camera or for specific technical information, please refer to the index.

Unfold the front and back flaps of this booklet for easy reference to camera parts while you read the instructions. Circled numbers after part names in the text correspond to numbers on pages 3 and 42.



Important Technical Information About Part I

I. Lens

1. For mechanical reasons, the AE-1's built-in meter cannot be used with the following older Canon lenses:

FL 19mm f/3.5	R 35mm f/2.5
FL 35mm f/2.5	R 50mm f/1.8
FL 50mm f/1.8	R 100mm f/2
FL 58mm f/1.2	

Make sure the film is advanced fully to the next frame before mounting one of these lenses.

2. To protect the pins and levers at the back of the lens, never place it rear-down on a hard surface.

3. Always make sure that the stop-down slide ❶ is unlocked before you mount a lens.

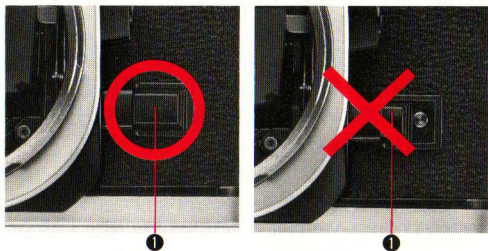

4. For more details on the lens, please see its instructions.

II. Battery

- 1.
- | Correct Batteries | Examples |
|-----------------------|---|
| Silver Oxide 6V | Eveready (UCAR) No. 544,
Mallory PX 28, JIS 4G13 |
| Alkaline-manganese 6V | Eveready (UCAR) No. 537 |
2. Try to make a habit of checking the battery at the following times:

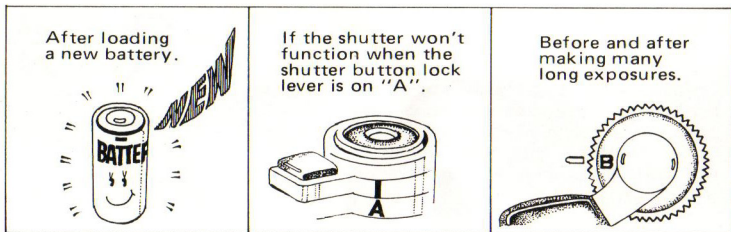

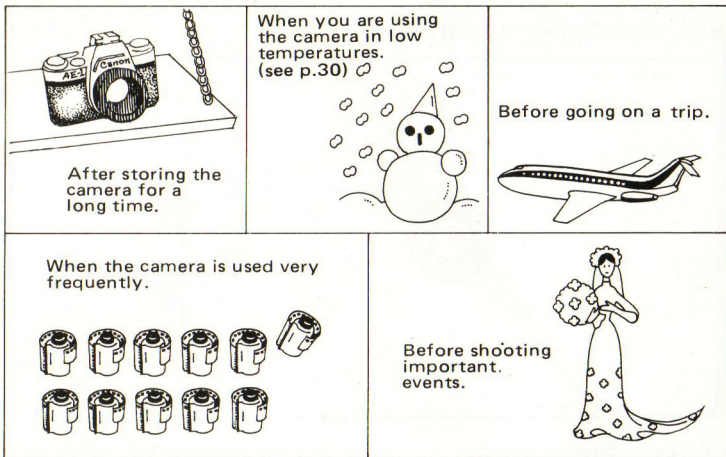

3. The AE-1's battery check circuit not only tells you whether the battery is good but also HOW good it is. When you check a new battery, the meter needle will rest below the battery check index. The weaker the battery, the higher the needle. If the meter needle is exactly in line with the index, the battery is still good but it will not last much longer. Have a new battery ready.

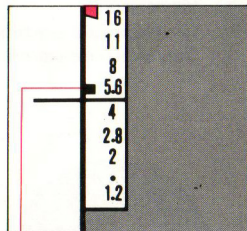

Battery Check Index

4. There are two other signs that the battery is weak and needs replacing:
- a) the meter needle takes more than about three seconds to come to a rest after you press the battery check button.
 - b) the meter needle fluctuates above and below the battery check index while the battery check button is pressed.
5. Pressing the battery check button **19**, the shutter button **14** or the exposure preview switch **2** uses battery power. When you are carrying the camera, take care that nothing presses down on these controls.
6. Remove the battery if you do not expect to use the camera for a long time.
7. Do not try to take the battery apart and never dispose of it in fire.

III. Viewfinder Information

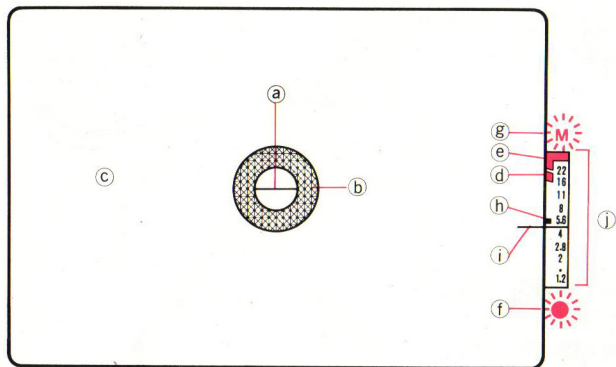

- Ⓐ Split-image rangefinder
- Ⓑ Microp prism rangefinder
- Ⓒ Matte screen
- Ⓓ Overexposure warning zone
- Ⓔ Overexposure warning zone
- Ⓕ Underexposure LED warning (red Light-Emitting Diode)
- Ⓖ Manual aperture control LED
- Ⓗ Battery check/Stopped-down metering index
- Ⓘ Meter needle
- ⓵ Aperture scale

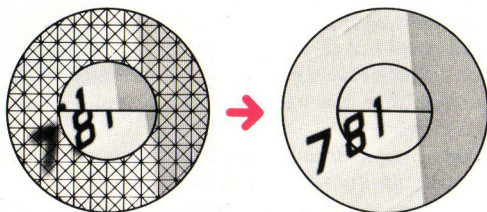

Out of Focus

In Focus

- Ⓐ — Ⓒ are aids to help you focus. They can be used alone or together.
- Ⓐ The split-image rangefinder divides the subject in half horizontally. The lens is in focus when the bottom half is even with the upper half. It is especially useful for a subject which has vertical lines. Half of it may darken if the smallest number on the lens' aperture scale ⓵ is 5.6 or greater. In this case, focus with the matte screen.

- (b) The microprism ring breaks the subject into tiny fragments, causing a shimmering effect when the lens is out of focus. Once the subject is in focus, it becomes clear and steady.
- (c) The matte screen causes fuzziness until the subject is in focus. It is particularly effective when you are using accessories for copying or close-ups (see p.26).
- (d) and (e) are overexposure warnings. If the meter needle touches one of these red zones when you press the shutter button halfway, it means that the shutter speed you have chosen is too slow or your film ASA is too high. Use these zones as follows:

Needle touches lower red zone

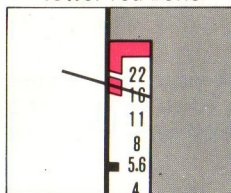

+ Largest number on lens aperture scale ⑤ is 22 or greater → OK

+ Largest number on lens aperture scale is 16 →



Needle touches upper red zone

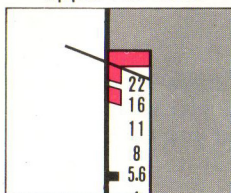

+ Largest number on aperture scale is 22 or smaller →

+ Largest number on aperture scale is 32

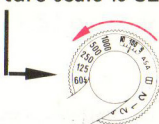

until

then

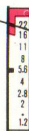

one click-stop



+ Shutter speed dial → Attach an ND filter or use a film with a lower ASA rating.

* An ND (Neutral Density) filter reduces the light intensity while having no effect on colors. Optional.

- Ⓕ is a blinking red LED which usually appears to indicate underexposure. Correct exposure by turning the shutter speed dial to a smaller number.

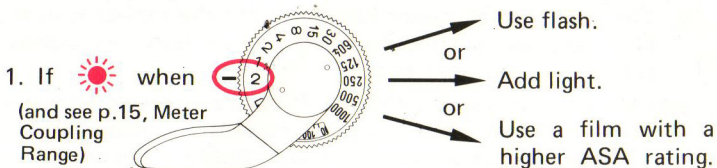

2. This LED also blinks whenever you set the shutter speed dial to "B" (see p.23) and, in a rare instance, when the shutter speed you have set is too slow for the film speed (see p.15). In these cases it does not mean underexposure.

- Ⓖ is a blinking red "M" LED which appears whenever you remove the aperture ring of an FD lens from "A" or when you mount a non-FD lens. See p.24. It warns you that exposure will not be automatic.

- Ⓗ, besides being the battery check index, is also the metering index for setting exposure with a non-FD lens and in close-up photography (see pp.24-26).

- Ⓘ and Ⓙ: When you press the shutter button halfway, the meter needle moves along the aperture scale to tell you what aperture the AE-1 has calculated for the shutter speed you have set. For more information on aperture, see p.16.

Notes

- Besides pressing the shutter button halfway, you can also turn the meter on to check exposure in the viewfinder by pressing the exposure preview switch . Pressing it uses battery power. Be careful not to press it when you don't mean to.
- The AE-1 has Central Emphasis Metering. Its sensitive silicon photocell reads the entire screen but more from the center which is where your subject usually is.

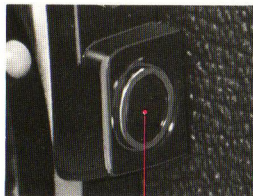

2

Exposure

Taking a picture is a matter of letting light fall on the film under controlled conditions. This is called exposure.

What happens when you press the shutter button? Some blades, called a diaphragm, inside the lens shift to form a hole called the aperture. In AE photography, the camera controls the size of that hole. Almost simultaneously, the first shutter curtain starts to move across the back of the camera. A second shutter curtain follows it at a fixed interval which you control with the shutter speed dial. How much light falls on the film depends on the shutter speed and the size of the aperture.

There are usually several combinations of shutter speed and aperture which will give the same exposure. This fact is the key to one of the most creative tools in photography. Find out more about it in the following three sections.

For the same exposure, a change in the shutter speed requires an equal and opposite change in the aperture. The AE-1 makes this change in aperture automatically.

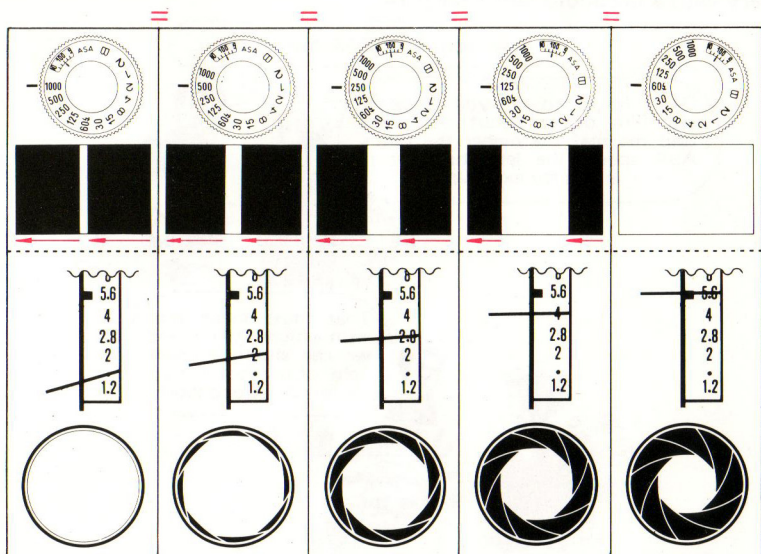

How to Choose a Shutter Speed

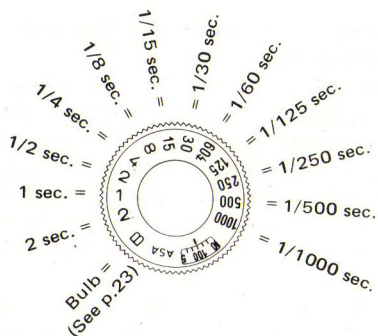

The camera has a shutter. It controls the length of exposure. Since the AE-1 is a shutter-speed priority automatic exposure camera, you control shutter speed directly with the shutter speed dial. The basic function of shutter speed is to get correct exposure, but you can also use it to control the expression of your subject's motion and to control camera movement.

To avoid blurred pictures from camera movement, it is best not to use a shutter speed slower than 1/60 second for handheld shooting with a standard (50 or 55 mm) lens. Even higher speeds are necessary with a telephoto lens. See p.14.

I wonder what ASA film speed is.

Oh, I forgot to tell you. I asked our film dealer about that. He told me that the higher the film's ASA speed, the less the light it needs for exposure.

That must mean that with a higher film speed we can shoot in lower light or use faster shutter speeds. Good work!

1. Usually a certain shutter speed is chosen to freeze the motion of a subject. The speed required to do this depends mostly on how fast your subject is moving. While it is possible to freeze the motion of a pedestrian at $1/60$ second, you need $1/1000$ second for a moving train. The motion of the bird in this photo was frozen at $1/1000$ second.



2. Blurring part of the picture intentionally can give a convincing sense of action. To blur the subject, simply set a shutter speed which is too slow to freeze its action. In this photo, it was blurred at $1/125$ second.

3. To blur the background, choose a relatively slow shutter speed, such as $1/30$ second, and shift the upper part of your body to follow the subject's motion during exposure.



Shooting at Shutter Speeds Slower Than 1/60 Sec. or with a Telephoto Lens

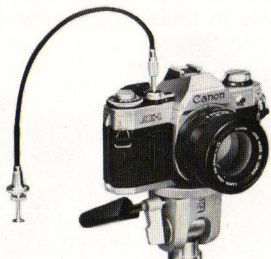

With a standard 50 or 55mm lens on your AE-1, a shutter speed of 1/30 second or slower is liable to result in blurred pictures because of camera movement when you are handholding the camera. Instead of using such slow shutter speeds, it is better to raise the shutter speed, if possible, add light or switch to flash.

If you cannot do any of these things, mount the camera on a sturdy tripod and use a cable release. Attach the camera to the tripod via the tripod socket ③. A cable release is an accessory which screws into a socket ② in the shutter button and allows you to release the shutter without touching the camera.

With a wide-angle (less than 50 mm) lens, it may be possible to use slightly slower shutter speeds than 1/60 second for handheld shooting. With a telephoto (more than 55 mm) lens, even faster speeds may not cancel camera movement.

Rule of Thumb:

Generally, do not use a number on the shutter speed scale ② which is any smaller than the focal length of the lens for handheld shooting. For handheld shooting with a 100mm lens, for instance, set a shutter speed of 1/125 second or faster; with a 200mm lens, at least 1/250 second. If this is not possible, use a tripod and a cable release.

Note

Canon offers an optional accessory called Tripod Adapter A. If the tripod head is quite large, it may be helpful to place this accessory between the camera and the head. Otherwise, it may be difficult to turn the focusing and aperture rings. This accessory may also be useful in preventing damage to the camera when the tripod screw is longer than the camera's tripod socket.

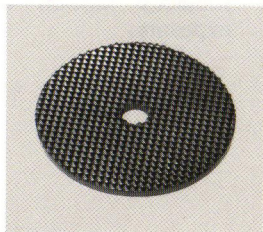

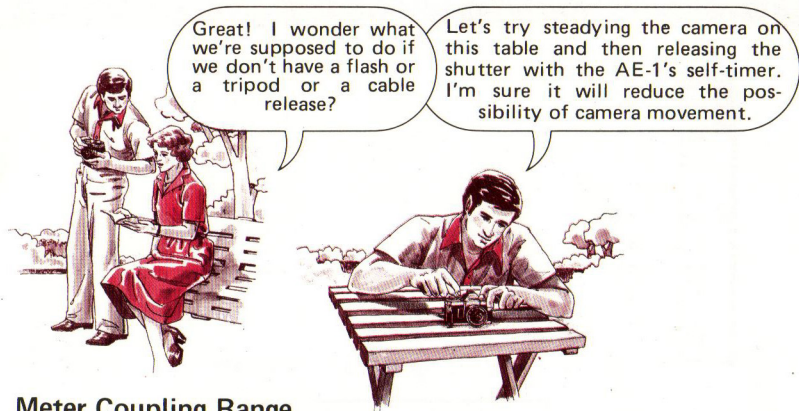

Meter Coupling Range

If the red LED blinks below the scale in the viewfinder when you have set a shutter speed slower than 1/60 second and press the shutter button halfway, it may not mean underexposure. By necessity, the slowest shutter speed you can use depends on the ASA film speed as shown in the following table. When you set a shutter speed outside the meter coupling range, the red LED blinks.

Meter Coupling Range	
ASA Film Speed	Usable Shutter Speed Range
25-50	2 — 1/1000sec.
64-100	1 — 1/1000sec.
125-200	1/2 — 1/1000sec.
250-400	1/4 — 1/1000sec.
500-800	1/8 — 1/1000sec.
1000-1600	1/15 — 1/1000sec.
2000-3200	1/30 — 1/1000sec.

Take the following steps to check for the cause of the red LED blinking at shutter speeds from 2 seconds to 1/30 second:

1. Check the table to see if the shutter speed is within the correct range for the film speed. If it is, the LED means underexposure.
2. If it is not, reset the shutter speed within the correct range. Now if the LED stops blinking, exposure is correct. If the LED is still blinking, it means that your picture will be underexposed.

Note

Expressed in other terms, the AE-1's meter coupling range extends from EV1 (1 sec. at f/1.4) to EV18 (1/1000 sec. at f/16) with ASA100 film and an f/1.4 speed lens.

Aperture, Exposure's Other Half: What It is and How It Affects the Picture

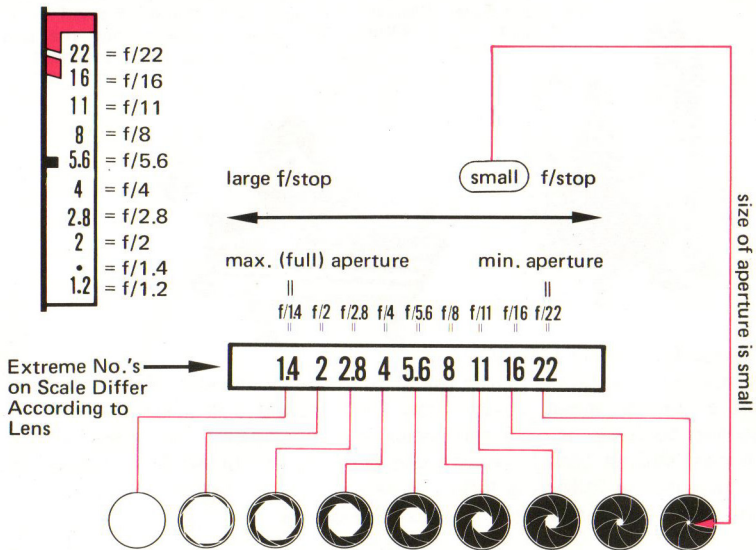

Extreme No.'s on Scale Differ According to Lens

The lens has diaphragm blades. They open and close to form certain-sized holes, or apertures, which control the amount of light allowed to expose the film. The aperture scale can be found on the lens ⑤ and in the viewfinder. The numbers on the scale are called f-numbers or f/stops.

The AE-1 selects the correct aperture automatically, based on lighting, the film speed and the shutter speed you have set. When you press the shutter button halfway, the meter needle points to the f/stop the AE-1 has set automatically. As lighting conditions change or as you move the camera, the needle moves to compensate for the change. The AE-1 does not fix the aperture until you press the shutter button to take the picture.

The aperture influences depth of field which, in turn, affects the way a picture will look. When your subject is in focus, there is a certain area in front of it and behind it which will also be in focus. This area of sharpness is called depth of field.

In portraits and still-life shots, a particular aperture may be more important to your picture than a particular shutter speed. To get the aperture you want, simply turn the shutter speed dial until the needle in the viewfinder points to that aperture. Keep in mind that the shutter speed should not be slower than 1/60 second for handheld shooting with a standard lens.

1. The smaller the aperture, the wider the range of sharpness. This is illustrated by this picture which was taken at f/16. Compare it

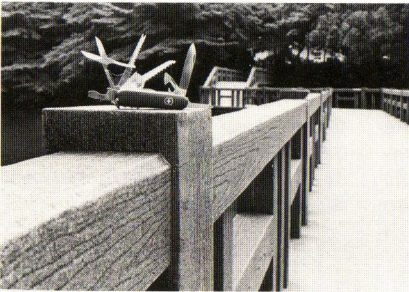

with the photo below. This extended depth of field is especially good for such subjects as landscapes.

2. The larger the aperture, the narrower the range of sharpness. An aperture of f/1.4, for instance, can isolate your subject from its surroundings. This is often used to blur a disturbing background in portraiture.

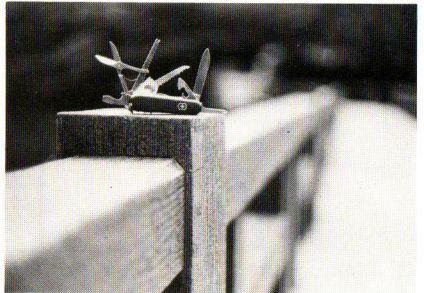

Note

Depth of field is also greater the shorter the focal length of the lens and the greater the shooting distance. It is generally greater in the background than in the foreground by a ratio of two to one.

Checking the Depth of Field

There are two ways to check the depth of field. The usual one is by using the depth-of-field scale **8** on the lens. This is a scale of f/stops repeated on each side of the distance index.

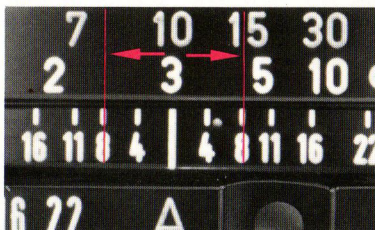
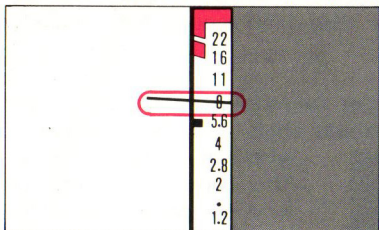

1. First focus. Then press the shutter button halfway and note to which number on the aperture scale the meter needle points. Find the two f/stops on the depth-of-field scale which correspond to that number.

2. Draw imaginary lines from those two numbers to the distance scale. The effective depth of field extends between those two distances.

You can roughly check the depth of field visually with an FD lens as follows:

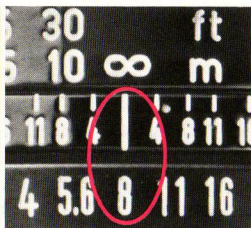
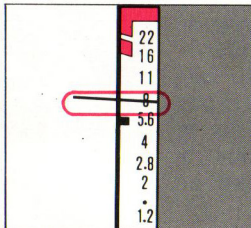
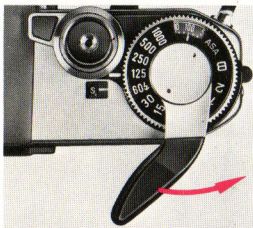

1. Make sure the film has been completely advanced.

2. Press the shutter button halfway to find out to which number the meter needle points in the viewfinder.

3. Then press in the EE lock pin **9** and turn the aperture ring **5** to that number.

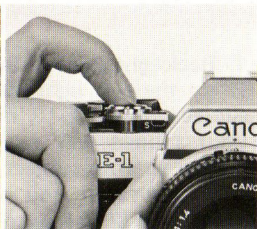
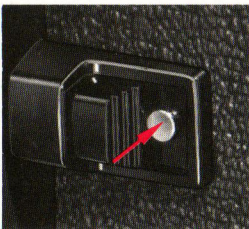
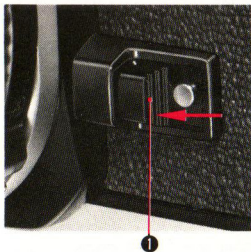

4. Push in the stop-down slide ❶ until it locks. Now, just by looking at your subject through the viewfinder, you can see the range of sharp focus.

5. After checking the depth of field, unlock the stop-down slide ❶. Now turn the aperture ring to the smallest number. Then turn it to the largest number, press the EE lock pin ❹ and return the aperture ring to "A".

6. Now you can take your shot.

Note

As a reminder that the lens is off "A", the red "M" will blink in the viewfinder when you press the shutter button halfway.

- ⊗ Do not push in the stop-down slide before you advance the film or the diaphragm will close down only as far as the aperture used for the previous exposure.
- ⊗ Do not reset the aperture ring to "A" before you turn it to the smallest number on the scale or your next frame will be incorrectly exposed.
- ⊗ When an FD lens is mounted DIRECTLY on the camera (with no accessories between), NEVER take a shot before releasing the stop-down slide ❶ or exposure may be incorrect. And, unless you want to make an exposure correction (p.22), return the aperture ring to "A" before shooting.

To check depth of field visually with a non-FD Canon lens, see p.24.

Shooting with Light Behind Your Subject (and Other Unusual Lighting Situations)

1. Backlight Control Switch

When there is light, such as the sun or a bright window, behind your subject, the AE-1's meter may be overinfluenced by that light and your subject will come out too dark. In order to give correct exposure to your subject, press the backlight control switch ③ and hold it in until after you press the shutter button ⑭. This will give the subject 1 1/2 f/stops more exposure.

Using the backlight control switch may also help you to expose your subject correctly when it is surrounded by bright snow or a sand beach in summer.

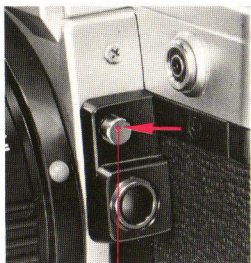

③

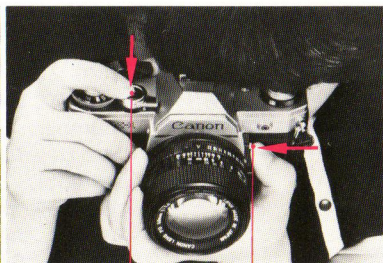

⑭

③



Backlit Subject without Correction



Backlit Subject with Backlight Control Switch Pressed

2. Adjusting the ASA

Sometimes, in a theater or concert hall, for instance, where it is quite dark, the AE-1's meter may be overinfluenced by the darkness and your subject will come out too light. To expose your subject correctly, turn the ASA film speed dial to a higher number. Each full step on the ASA film speed dial equals one f/stop. If ASA 200 film is loaded, for instance, and you turn the dial to ASA 400, your subject will receive one f/stop less exposure. Exactly how much higher you should set the ASA film speed dial depends on the situation. To be on the safe side, you may wish to bracket the exposure (see next page).

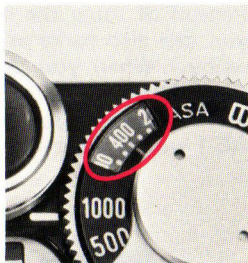

Note

Just as doubling the ASA will underexpose the picture one f/stop, halving it (setting the dial to ASA 100 for ASA 200 film) will overexpose the picture one f/stop. Changing the ASA to a lower value serves the same purpose as pressing the backlight control switch except that you have more control over how much extra exposure your subject gets.

- ⊗ Following exposure, do not forget to reset the film speed dial to the correct ASA film speed, or all following frames will be incorrectly exposed!

Look at this. The whole last half of the roll is terrible!



Gee, that's strange. The first half is okay. The last good frame is great. Looks like exposure might have been a little tricky.

Yeah, I'm especially proud of that one. I changed the ASA like they say in the instructions.



Did you also reset the correct ASA afterwards like they say in the instructions?

Oh, no!



3. Manual Override

Instead of using the backlight control switch or changing the ASA, you can also make an exposure correction by canceling AE photography. When you do this, you will be setting both shutter speed AND APERTURE by yourself. This is called manual override and is useful whenever you want to set a different aperture than the one the AE-1 would select automatically in AE.

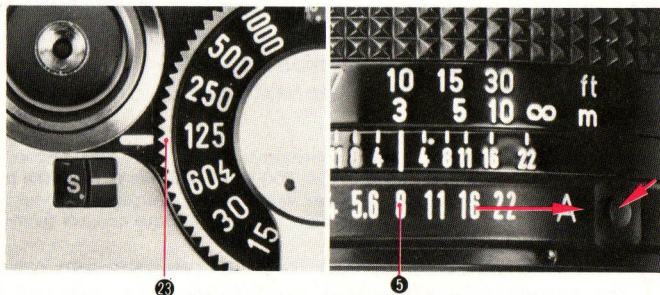

1. Set a shutter speed by turning the shutter speed dial 23 as usual.
2. Remove the lens from "A" and set an aperture by turning the aperture ring 5.

Note

When you press the shutter button halfway, the meter needle will point to the aperture that the AE-1 would select automatically as usual. You may wish to use this aperture reading as a basis for setting an aperture on the aperture ring. A red "M" will blink above the aperture scale in the viewfinder to remind you that the lens is removed from "A".

You may find it worthwhile to bracket the exposure. This means taking several shots at different exposures so that at least one of them turns out correctly exposed. Take the first shot at the exposure you think is right. Then take a couple more, one with the aperture ring set one step higher and the other with it set one step lower. It is possible to do the same thing by changing the ASA setting or the shutter speed.

Shooting at Night

In very dim lighting, such as at night, it may be necessary to make an exposure longer than the slowest shutter speed of 2 seconds. This is what the "B" setting of the shutter speed dial is for. When you use this "B" setting, the shutter will remain open as long as you press the shutter button. AE photography is not possible; switch to manual override (facing page). As in manual override, a red "M" will blink in the viewfinder when you take a meter reading.

The "B" setting is useful whenever it is too dark for metering. It is also the best way to record several bursts of fireworks on a single frame.

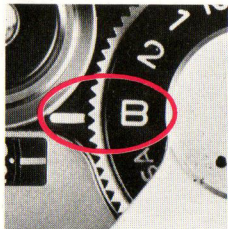

Notes

1. The AE-1's meter will not give a reading at the "B" setting. The meter needle will remain at the bottom of the scale and the red LED will blink below the scale in the viewfinder. You will have to experiment to find the best combination of aperture and exposure duration.
2. Always use a tripod and cable release, preferably lockable (p.14), for time exposures, and remember that the "B" setting uses more battery power. We suggest carrying a spare battery to be on the safe side.

Shooting with a Non-FD Lens

With a Canon FD lens, metering and viewing are done at maximum aperture where the viewfinder is brightest and easiest to see. The lens does not close down to the shooting aperture until shutter release after which it automatically reopens to maximum aperture. This is called full-aperture metering.

Stopped-down Metering

With a Canon FL lens, the Canon Reflex 500mm or TS 35mm lens or any other non-FD lens, full-aperture metering is not possible. The lens must actually be closed (stopped down) to the shooting aperture for metering. This is called stopped-down metering. In stopped-down metering, the lens diaphragm will open or close as you turn the aperture ring ⑤.

1. Push the stop-down slide ① towards the lens until it locks.

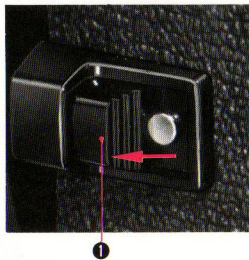

2. Press the shutter button halfway or press the exposure preview switch ② and turn the aperture ring and/or the shutter speed dial until the meter needle is in line with the battery check/stopped-down metering index. A red "M" will blink in the viewfinder to indicate manual aperture control.

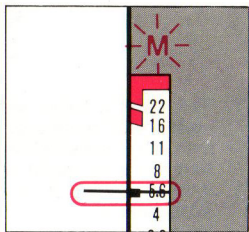

3. Press the shutter button all the way down for exposure.

Note

Once the lens is stopped down, you can check depth of field visually simply by inspecting the subject through the viewfinder.

- ⊗ NEVER try to do stopped-down metering with an FD lens unless there are close-up accessories between it and the camera. If you do stopped-down metering when an FD lens is mounted directly on the camera, exposure may not be correct.



Shooting with Close-up Accessories

With few exceptions (noted in the instructions for the accessory), stopped-down metering is necessary whenever you insert an accessory between the camera and lens for close-up photography.

1. If you insert an accessory designed for **AUTOMATIC** diaphragm control, such as the Auto Bellows or Bellows FL, between the camera and **ANY** lens, follow the steps (p.24) for stopped-down metering. (Note that the FD-U Extension Tubes are designed for normal full-aperture metering).
2. If you insert an accessory designed for **MANUAL** diaphragm control, such as M Extension Tubes or Bellows M, between the camera and a **NON-FD** lens, follow the steps (p.24) for stopped-down metering. Turn the A-M ring of an FL lens to "M" for taking the shot (not necessary if Canon Macro Auto Ring and Double Cable Release are used).
3. If you insert an accessory designed for **MANUAL** diaphragm control between the camera and an **FD** lens, unless you use the Canon Macro Auto Ring and Double Cable Release, first set the lens for manual diaphragm control (next page) before mounting it on the accessory. Then follow the steps (p.24) for stopped-down metering.

Note

The aperture ring of an FD lens must be removed from "A" before you mount the lens on any of these close-up accessories except for FD-U Extension Tubes.

Film Plane Indicator

This mark is engraved on top the camera body to indicate the exact position of the film plane. It is useful for measuring the exact shooting distance from film to subject in close-up photography. Distances on the lens' distance scale are calibrated from this mark. It is not used in general photography.

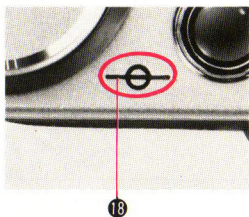

Manual Diaphragm Control

The instructions for the accessory will tell you whether or not manual diaphragm control is necessary. The procedure differs according to the type of lens.

FD Lens without Chrome Mount Ring except for FD Macro Lenses

1. Insert the slot of the accessory manual diaphragm adapter over the tip of the automatic aperture lever at the rear of the lens. Push the lever counterclockwise and lower the adapter into the groove.

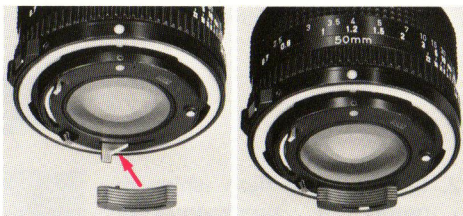

2. Mount the lens on the accessory.

⊗ When the manual diaphragm adapter is attached, NEVER mount the lens DIRECTLY on the camera or on an accessory designed for automatic diaphragm control, such as the Auto Bellows or Bellows FL.

FD Lens with Chrome Mount Ring and All FD Macro Lenses

1. Push the automatic aperture lever at the rear of the lens counterclockwise until it automatically locks.
2. Mount the lens on the accessory.

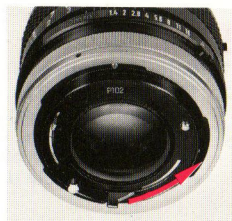

Note

Some of these lenses have an additional lock lever. With these lenses, push the automatic aperture lever fully counterclockwise, then push the lock lever to "L".

- ☑ Be sure to reset the automatic aperture lever to its normal position before mounting the lens DIRECTLY on the CAMERA. In the case of a lens with a lock lever, switch it back to the position of the white dot.

Flash Photography

The AE-1 has two flash terminals.

1. Insert a direct-contact hot-shoe type flash directly in the accessory shoe ⑳. For this type of flash, no other connection is necessary.
2. If you use a flash which requires a synchronization cord, branch the cord between the flash and the camera's PC socket ㉑.

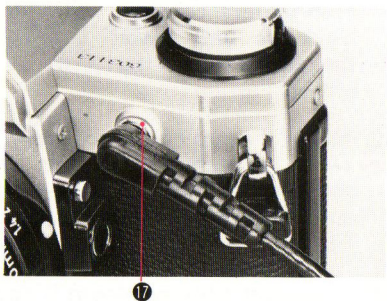
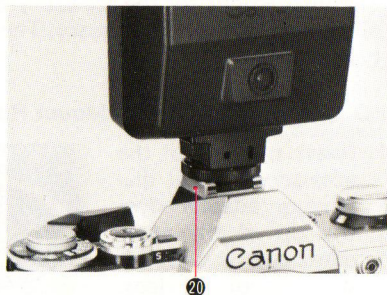

Notes

1. Before mounting a flash unit, make sure its power switch is OFF.
2. Two flash units can be fired simultaneously by placing one in the accessory shoe and connecting the other to the PC socket.
3. It is recommended to use a Canon flash unit on this camera. Using a flash or flash accessory of another make may cause the camera to work improperly or even possibly damage the camera itself.

Automatic Flash (with Ordinary Electronic Computer Flash Units)

1. Turn the AE-1's shutter speed dial to 1/60 second.
2. Remove the aperture ring of an FD lens from "A" and turn it to the automatic aperture which you have set on the flash.

Note

For more details, see the instructions for the flash.

Manual Flash

1. Set the shutter speed dial according to the information in the table below:

Type		Synchronized shutter speed											1	2	B
		1/1000	1/500	1/250	1/125	1/60	1/30	1/15	1/8	1/4	1/2				
Flash Bulbs	FP class						△	○	○	○	○	○	○	○	○
	M and MF class						△	○	○	○	○	○	○	○	○
Electronic Flash						○	○	○	○	○	○	○	○	○	○

○ = okay

△ = possible unevenness in picture depending on bulb

2. Calculate the aperture with a guide-number formula or with the flash unit's calculator dial if it has one. Turn the lens' aperture ring to that aperture.

Note

For more details, see the instructions for the flash.

Shooting with Infrared Film

When you load the AE-1 with black-and-white, infrared film, it is necessary to make a slight adjustment in focus. A red infrared index is engraved on most Canon lenses for this purpose. First focus as usual through the viewfinder. Then read the distance opposite the distance index **8** on the lens and turn the focusing ring to align that distance with the infrared index. It will also be necessary to use a deep red filter, as specified by the film manufacturer, over the lens.

Note that it is not necessary to adjust the focus with color infrared film. For further details, follow the instructions of the film manufacturer.

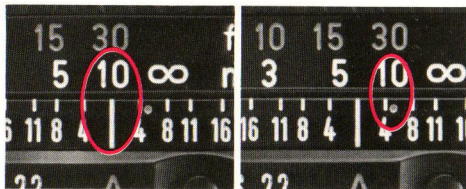

Shooting in Very Low Temperatures

When you use the AE-1 in temperatures below 0°C (32°F), there are two things you should keep in mind. First, battery power may decrease or fail altogether. Second, extreme temperature changes may damage the camera unless certain precautions are taken.

Try to remember the following:

1. Load a new battery, and keep the camera warm until you are ready to shoot. Try to finish the shooting session as quickly as possible. If you must shoot for a long time, carry a spare battery. Alternate the two batteries, keeping the one that is not in use warm. Do not throw the original battery away. That it does not perform well in the cold does not necessarily mean that it will not work normally again in warmer temperatures. An optional accessory, the Canon External Battery Pack A, is the most reliable power source for uninterrupted shooting in cold weather.
2. Condensation forming on a camera and lens taken from cold outside temperatures into a warm room may cause corrosion. To avoid this, while still outdoors place the camera in a plastic bag. Then seal the bag and take it indoors. Leave the camera in the bag until it gradually reaches room temperature. Generally, this takes about one-half hour.

R

Armin de Fer

A black and white photograph of a woman with dark, wavy hair, smiling and looking towards the camera. She is wearing a light-colored, short-sleeved, floral-patterned dress with a ruffled neckline and a matching short skirt. She is standing next to a dark-colored car, with her right hand resting on the door handle. The background is dark, suggesting an outdoor night setting. To the left, there is a large, illuminated sign that reads "Armin de Fer" in a cursive font. Above the sign, there is a large, stylized "X" graphic made of light-colored material. The overall scene appears to be a promotional event or a fashion show.

Optional Accessories

CANON A - SERIES SYSTEM ACCESSORIES

Your AE-1's advanced electronics has enabled Canon to design a number of unique accessories for it. Controlled by the AE-1's microcomputer, they give unprecedented shooting versatility and handling ease.

Power Winder A

This accessory attaches to the camera in seconds where it advances the film and readies the camera for the next shot automatically. Hold in the shutter button and you can shoot at about two frames per second at any shutter speed from 1/60 sec. to 1/1000 sec. Release the shutter button after every exposure and the film will advance and the shutter recock automatically at any shutter speed on the dial. Your subject is moving fast and you don't want to miss a second of the action? Or are you just plain tired of advancing the film? The Power Winder A is the answer.







Speedlites 133A, 155A, 177A and 199A

For the easiest possible flash photography with the AE-1, Canon offers four Speedlites. With an FD lens, the shutter speed switches to 1/60 sec. and the aperture is set to the auto aperture set on the flash automatically the moment the pilot lamp glows. The lens' aperture ring remains right on "A". Just as automatically will the camera switch to normal AE photography the moment the pilot lamp goes out. No other flash units offer these features. With a non-FD lens, the shutter speed still switches to 1/60 sec. automatically while you have only to turn the aperture ring to the auto aperture set on the flash. This is also possible with an FD lens. Then again, you can switch to manual flash photography with three out of four of these Speedlites (see table).



When you are finished using the flash, you can shoot normally while the flash is still mounted simply by turning its main switch off. With four units available, you have a wide range of features to choose from. The following table lists some of the most important.

Speedlite	133A	155A	177A	199A
Feature				
Guide Number	16(m, ASA100); 26(ft., ASA25)	17(m, ASA100); 28(ft., ASA25)	(w/o Adapter) 25(m, ASA100); 41(ft., ASA25)	(w/o Adapter) 30(m, ASA100); 50(ft., ASA25)
Min. Usable Lens Focal Length	35mm	35mm	35mm ; 28mm with Adapter	35mm ; 24mm with Adapter
Max. # of Auto Apertures (Differs with ASA)	1	2	2	3
Auto Shooting Dist. Range, Min. to Max. (Differs with Auto Aperture)	0.5-8m 2-26ft.	0.5-6m 2-20ft.	0.5-9m 2-29ft. less with Adapter	0.5-10.6m 2-35ft. less with Adapter
Bounce	No	No	No	Yes
Manual Flash	No	Yes	Yes	Yes

Data Back A

The Data Back replaces the AE-1's back cover in seconds where it will record the date in the lower right-hand corner of the photo automatically at shutter release — or manually afterwards if you wish — or not at all if you don't want it on a particular frame. You can leave it attached even when you are not using it or reattach the back cover as quickly as you removed it. Date-guessing will become a thing of the past. Since letters of the alphabet and Roman numerals can also be recorded, it is also a convenient coder — a point of particular interest for technical photographers.

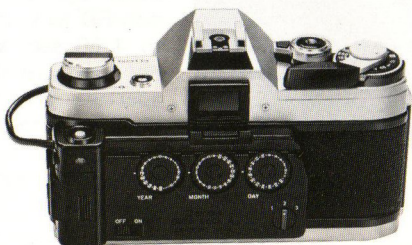

OTHER ACCESSORIES

Lens Hood

We strongly recommend the use of a lens hood to keep out side light rays which may cause flare and ghost images to form on the image. Rigid Canon hoods also help to protect the lens from shock. Only use a hood which is specified for your particular lens. Most Canon hoods fit into the bayonet mount at the front of the lens ³² and are fixed by turning. Some can be reverse-mounted and will fit into the camera case. For more details, please see the lens' instructions.



Dioptric Adjustment Lenses S

These are eyesight correction lenses which slip into the eyepiece grooves from above. Ten are available in the powers of +3, +2, +1.5, +1, +0.5, 0, -0.5, -2, -3 and -4 diopters. They may make viewing and focusing easier if you are near- or far-sighted. Choose the one which is closest to your eyeglass prescription, then make a practical test if possible.

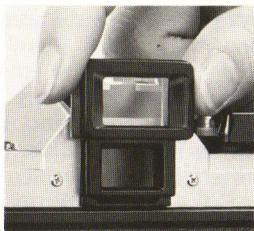

Angle Finders A2 and B

There are some types of photographic subjects for which viewing them through the eye-level viewfinder of the camera is uncomfortable. This is particularly true in the fields of copying, close-ups, photomacrography and photomicrography. Then it might be more convenient to mount one of these angle finders over the camera's eyepiece. Both angle finders rotate 90° for comfortable viewing from above or from the side.

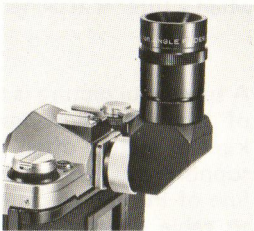

Angle Finder A2 gives a correct image top-to-bottom but reversed left-to-right while the more sophisticated Angle Finder B gives a completely normal image. Both show the entire field of view as well as viewfinder information.

Magnifier S

The Magnifier S inserts into the grooves of the viewfinder eyepiece with its adapter to give a 2.5X magnification of the center of the viewing area for precision focusing in close-up work and wide-angle photography. Its power is adjustable to your eyesight within a range of +4 to -4 diopters. Its adapter is hinged so that the magnifier can be swung upward from the eyepiece after focusing, leaving the entire screen image visible.

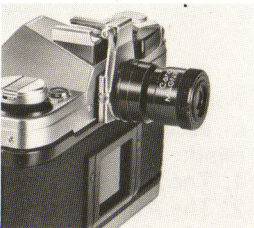

Filters

Most Canon lenses accept screw-in filters which screw into the front  of the lens. Canon offers a wide variety of filters for both color and black-and-white films. A holder for gelatin filters is also available. Since the AE-1 has a through-the-lens meter, it is not necessary to correct exposure with filter factors when a filter is attached.

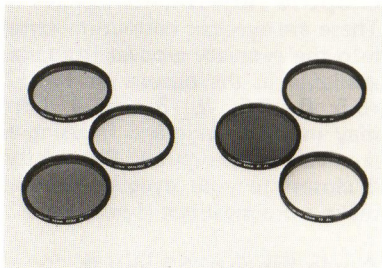

A successful picture is the product of your personal vision, a smidgeon of technical know-how and the right equipment. Taking a special kind of picture often requires special equipment. We stand ready to support you with our vast system of accessories. From our famous line of FD and special-purpose lenses to bellows units and copy stands to cable releases, we offer just about every accessory you will ever need to take any kind of picture.

For further reading about photography and for quick understanding of accessories, it may be convenient to keep the following points in mind:

1. The AE-1 is a single-lens reflex (SLR) camera.
2. The AE-1 is a shutter-speed priority automatic exposure (AE) SLR with the possibility of manual override.
3. The AE-1 has a through-the-lens meter. Metering takes place at full aperture with a Canon FD lens.

Care of the Camera

Your AE-1 is a precision instrument which should be handled with proper care. Rugged and reliable under normal use, it can be damaged by moisture, heat, shock or the use of force. Observing the following few simple rules will keep your AE-1 in top condition at all times.

1. The best thing you can do for your AE-1 is to use it regularly. In the event that you must store it for quite a while, first remove it from any soft case or camera bag. Remove the battery. Wrap the camera in a clean, soft cloth and place it in a cool, dry, dust-free area. If you store the body and lens separately, attach both the body and rear lens caps.
2. Keep the camera and lens out of direct sunlight and away from "hot spots", such as the trunk, rear window shelf or glove compartment of a car. Do not store the camera in a laboratory or other such area where chemicals may cause corrosion.
3. To keep the camera in top condition during prolonged storage, occasionally replace the battery and take several blank shots. Check the operation of each part before you use the camera following a long storage.
4. Water, spray, excessive humidity, dust and sand are your camera's worst enemies. Keep it away from dust and humidity. Clean it especially well immediately after you use it on the beach.
5. To clean the exterior of the camera body, first blow off dust with a blower brush. Wipe off smudges with a silicone cloth or chamois leather. If smudges remain on the eyepiece after using a blower brush, wipe it lightly with lens cleaning tissue which has been moistened with a couple of drops of lens cleaner.
6. If the mirror gets dirty, it will not affect pictures but it may make viewing difficult. Dust it VERY gently with a blower brush. If further cleaning is necessary, NEVER do it yourself but take the camera to the nearest authorized Canon service facility.
7. The film chamber needs cleaning from time to time to remove film dust which may scratch the film. Gently dust it out with a blower brush. Be careful NEVER to exert pressure on the film rails, shutter curtain and pressure plate.
8. To clean the lens surfaces use only a blower brush, cleaning fluid and tissue made specially for cleaning camera lenses. Carefully follow the lens' instructions. Chamois leather or a silicone cloth may be used for wiping smudges off the lens barrel – NEVER use such cloths on the glass surfaces!

Specifications

Type: 35mm SLR (Single-lens Reflex) camera with electronically-controlled shutter-speed priority AE (automatic exposure) and focal-plane shutter.

Format: 24 x 36mm.

Usable Lenses: Canon FD (for full-aperture AE) and Canon FL and special non-FD (for stopped-down metering) series lenses.

Lens Mount: Canon breech-lock mount.

Viewfinder: Fixed eye-level pentaprism. Gives 93.5% vertical and 96% horizontal coverage of actual picture area with 0.86X magnification at infinity with a standard lens. Information includes split-image/micropism rangefinder, aperture scale with meter needle, battery check/stopped-down metering index, overexposure and underexposure warnings and manual aperture signal.

Mirror: Instant-return, with shock-absorber.

AE Mechanism: Electronically-controlled, shutter-speed priority AE metering system using two ICs and one LSI with I²L.

Light Metering System: Through-the-lens, Central Emphasis Metering by SPC (Silicon Photo Cell).

Meter Coupling Range: EV1 (1 sec. at f/1.4) to EV18 (1/1000 sec. at f/16) with ASA 100 film and f/1.4 speed lens.

Exposure Correction: +1.5EV automatic correction with backlight control switch.

Meter Switch: Shutter button or exposure preview switch.

Shutter: Cloth, focal-plane, 4-spindle, electronically-controlled. With shock and noise absorbers.

Shutter Speed Dial: 2 sec.—1/1000 sec. and "B". X (flash) synchronization at 1/60 sec. With guard.

ASA Film Speed Dial: ASA 25 to ASA 3200.

Shutter Release Button: Two-step, electromagnetic shutter release button. Also serves as meter switch. With lock and cable release socket.

Self-Timer: Electronically-controlled. Ten-second delay with red LED signal. Cancellation possible.

Stop-down Slide: For depth-of-field preview (FD lens) or metering (non-FD lens or close-up accessories).

Power Source: One 6V silver oxide (Eveready [UCAR] No.544, JIS 4G13, Mallory PX 28) or alkaline-manganese (Eveready [UCAR] No.537) battery. Battery lasts about one year under normal use.

Battery Check: Meter needle/power level index method with battery check button.

Flash Synchronization: X synchronization at 1/60 sec.; M synchronization at 1/30 sec. or slower. Direct contact at accessory shoe for hot-shoe flash. PC socket (JIS-B type) with shock-preventive rim for cord-type flash. Accessory shoe has contact for normal automatic flash plus special contact for AE flash with dedicated Canon Speedlites.

Back Cover: Opened with rewind knob. Removable. With memo holder.

Film Loading: Via multi-slot take-up spool.

Film Advance Lever: Single-stroke 120° throw with 30° stand-off. Ratchet winding possible.

Frame Counter: Additive type. Automatically resets to "S" upon opening back cover. Counts backwards as film is rewound.

Film Rewind: With rewind button and crank.

Dimensions: 141mm x 87mm x 47.5mm (5-9/16" x 3-7/16" x 1-7/8"), body only.

Weight: 590 g (20-13/16 ozs.), body only.

770 g (27-3/16 ozs.) with FD 50mm f/1.8 lens.

825 g (29-1/8 ozs.) with FD 50mm f/1.4 lens.

Subject to change without notice.

Index

Page references from Part I, if any, come first and are followed by (I).

- Accessory Shoe, pp.17(I), 28
- AE Photography, pp.5(I), 11, 12, 16
- “A” Mark (on lens), pp.5(I), 22
- Angle Finders A2 and B, p.35
- Aperture, pp.11, 16–17
 - Influence on Picture, p.17
 - Scale, on lens, p.16
 - Scale, in viewfinder, pp.8, 10, 11, 16
- ASA, (see Film Speed)
- Backlight Control Switch, pp.15 (I), 20
- Backlighting, pp.15(I), 20
- Battery, pp.6–7(I), 6–7, 23, 30
 - Checking, pp.7(I), 6–7
 - Loading, p.6(I)
 - Precautions, pp.6–7(I), 6–7, 30
 - Usable Batteries, pp.6(I), 6
- Battery Check Button, pp.7(I), 19(I), 7
- Cable Release, pp.14, 23
- Cable Release Socket, p.14
- Camera
 - Carrying, p.20(I)
 - Cleaning, p.37
 - Holding, p.13(I)
 - Semi-hard Case, p.20(I)
 - Storage, p.37
 - Use in Low Temperatures, p.30
- Camera Movement, pp.13–14(I), 12, 14, 17
- Composition, p.15(I)
- Data Back A, p.34
- Depth of Field, pp.16–19, 25
 - Scale, p.18
 - Visual Preview, Canon FD lens, pp.18–19
 - Visual Preview, Canon non-FD lens, pp.24–25
- Dioptric Adjustment Lenses, p.35
- EE Lock Pin, p.5(I), 19
- Exposure, pp.11–12, 16
 - Automatic, pp.11, 16
 - Bracketing, pp.21–22
 - Correction, pp.15(I), 20–22
 - Manual, pp.22, 23
 - Measurement, pp.14(I), 9–10
 - Preview, pp.14(I), 10
 - Warnings, pp.14(I), 9–10
- Exposure Preview Switch, pp.7, 10
- Eyecup 4S, p.15(I)
- F/stop, p.16
- Film
 - Infrared, p.30
 - Loading, pp.10–12(I)
 - Usable, p.10(I)
- Film Advance Lever, p.8(I)
- Film Plane Indicator, p.26
- Film Rails, pp.11(I), 37
- Film Rewind Button, p.16(I)
- Film Speed, pp.9(I), 9–10, 12, 21
 - Setting, p.9(I)
- Film Speed Scale, p.9(I)
- Filters, pp.9, 36
 - Gelatin, p.36
 - Neutral Density (ND), p.9
 - Screw-in, p.36
- Flash, pp.17(I), 10, 14, 28–29
 - Automatic, p.29
 - Manual, p.29
 - Synchronization Shutter Speeds, p.29
 - Terminals, p.28
 - With Canon Speedlites, p.17(I)
- Flash Sync Terminal, p.28

- Focusing, pp. 15(I), 8—9
 - Accessories, p.35
 - Aids, pp.8—9
- Frame Counter, p.12(I)
- Full-aperture Metering, pp.24, 36
- Infrared Index, p.30
- Lens, pp.3—5(I), 15(I), 21(I), 6, 12, 14, 24—25, 27
 - Caps, pp.3(I), 5(I)
 - Canon FD, pp.5(I), 18—19, 24, 25, 26—27
 - Canon FL, pp.6, 24—26
 - Dismounting, pp.5(I), 6
 - Hood, p.34
 - Manual Diaphragm Control, pp.26—27
 - Mounting, pp.3—4(I), 6
 - Release Button, pp.4—5(I)
 - Setting for AE Photography, p.5(I)
 - Special non-FD Lenses, pp. 24—25
 - Telephoto, p.14
 - Unusable with Meter, p.6
- Magnifier S, p.35
- Manual Diaphragm Control (see Lens)
- Manual Override, p.22
- Memo Holder, p.9(I)
- Meter Coupling Range (see Viewfinder Information)
- Meter Reading, pp.8(I), 10
- Mirror, p.37
- “M” Signal (in Viewfinder), (see Viewfinder Information)
- Neckstrap, p.20(I)
- Neutral Density (ND) Filter, p.9
- PC Socket (see Flash Sync Terminal)
- Power Winder A, p.32
- Self-timer, pp.18—19(I), 15
- Cancellation, p.19(I)
 - Lamp, p18(I)
- Shutter Curtain, pp.11(I), 11, 37
- Shutter Release Button, pp.8(I), 7
 - Lock Lever, pp.8(I), 18(I), 20(I)
- Shutter Speed, pp.14(I), 9, 10, 11, 12—15, 16
 - Effect on Camera Movement, pp.12, 14
 - Flash Synchronization, p.29
 - For Telephoto Lens, p.14
 - Influence on Picture, pp.12—13
 - Setting, p.14(I)
 - Slow Range, pp.14—15
- Shutter Speed Scale, p.12
 - “B” Setting, p.23
 - Numbers below 60, pp.14—15
- Speedlites, pp.17(I), 33
- Stopped-down Metering, pp.24—25, 26
- Stop-down Slide, pp.4(I), 6, 19, 24
- Through-the-Lens Metering, p.36
- Time Exposures, p.23
- Tripod, pp.14, 23
- Tripod Adapter A, p.14
- Tripod Socket, p.14
- Viewfinder Cover, pp.6(I), 18(I)
- Viewfinder Information, pp.7(I), 14—15(I), 8—10
 - Aperture Scale, pp.10, 11, 16
 - Focusing Aids, pp.8—9
 - “M” Signal, pp.10, 18, 22, 23, 24
 - Meter Coupling Range, pp.10, 15
 - Meter Needle, pp.7(I), 14(I), 7, 9, 10, 16
 - Overexposure Warnings, p.9
 - Underexposure Warning, p.10

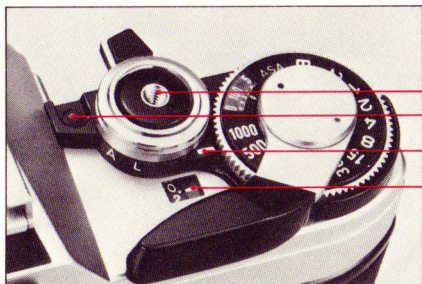

- 25 Cable Release Socket
- 26 Self-timer Lamp
- 27 Shutter Speed Index
- 28 Frame Counter



- 36 Winder Guide Hole
- 35 Winder Coupler Cover
- 34 Film Rewind Button

- 33 Tripod Socket
- 32 Front Bayonet for Hood
- 31 Memo Holder
- 30 Lens Release Button

- 29 Winder Terminals





CANON INC. 11-28, Mita 3-chome, Minato-ku, Tokyo 108, Japan

U.S.A. ————— **CANON U.S.A., INC. HEAD OFFICE**
10 Nevada Drive, Lake Success, Long Island, N.Y. 11042, U.S.A.

CANON U.S.A., INC. MANHATTAN SERVICE STATION
600 Third Avenue, New York, N.Y. 10016, U.S.A.

CANON U.S.A., INC. ATLANTA OFFICE
6380 Peachtree Industrial Blvd., Norcross, Georgia 30071, U.S.A.

CANON U.S.A., INC. CHICAGO OFFICE
140 Industrial Drive, Elmhurst, Illinois 60126 U.S.A.

CANON U.S.A., INC. LOS ANGELES OFFICE
123 Paularino Avenue East, Costa Mesa, California 92626, U.S.A.

CANON U.S.A., INC. LOS ANGELES SERVICE STATION
3407 West 6th Street, Los Angeles, California 90020, U.S.A.

CANON U.S.A., INC. SAN FRANCISCO SERVICE STATION
776 Market Street, San Francisco, California 94102, U.S.A.

CANON U.S.A., INC. HAWAII OFFICE
Bldg. B-2, 1050 Ala Moana Blvd., Honolulu, Hawaii 96814, U.S.A.

CANADA ————— **CANON OPTICS & BUSINESS MACHINES CANADA, LTD.**
HEAD OFFICE

3245 American Drive, Mississauga, Ontario L4V 1N4, Canada

CANON OPTICS & BUSINESS MACHINES CANADA, LTD.
MONTREAL OFFICE

3070 Brabant-Marineau Street, St. Laurent, Quebec H4S 1K7, Canada

CANON OPTICS & BUSINESS MACHINES CANADA, LTD.
VANCOUVER OFFICE

5900A, No.2 Road, Richmond, B.C. V7C 4R9, Canada

CANON OPTICS & BUSINESS MACHINES CANADA, LTD.
EDMONTON SERVICE CENTER

5222-86 St. Edmonton, Alberta T6E 5J6, Canada

EUROPE AFRICA
& MIDDLE EAST ————— **CANON AMSTERDAM NV**

P.O. Box 7907, 1008 AC Amsterdam, The Netherlands

CANON AMSTERDAM NV CAMERA SERVICE CENTER
Gebouw 70, Schiphol Oost, The Netherlands

CENTRAL &
SOUTH AMERICA ————— **CANON LATIN AMERICA, INC. SALES DEPARTMENT**

P.O. Box 7022, Panama 5, Rep. of Panama

CANON LATIN AMERICA, INC. REPAIR SERVICE CENTER
P.O. Box 2019, Colon Free Zone, Rep. of Panama

SOUTHEAST ASIA ————— **CANON HONGKONG TRADING CO., LTD.**

5th Floor 2-6, Fui Yiu Kok Street, Tsuen Wan, New Territories, Hong Kong

OCEANIA ————— **CANON AUSTRALIA PTY. LTD.**

22 Lambs Road, Artarmon, Sydney 2064, Australia