

WILSONWERKS ARCHIVES

This camera manual is for reference and historical purposes, all rights reserved.

This cover page is copyrighted material. This document may not be sold or distributed without the express consent of the publisher.

©2008-2025 wilsonwerks Llc

Canon

EOS

REBEL II / REBEL S II

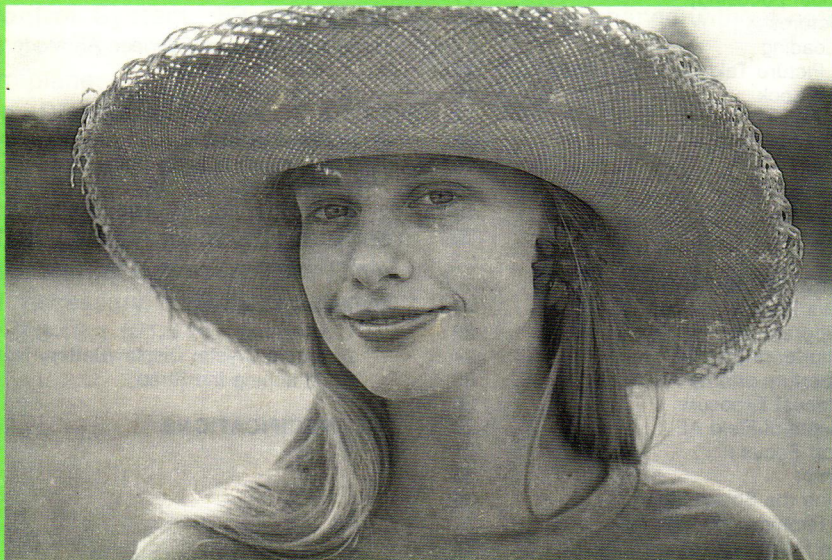

E

English Edition

INSTRUCTIONS

Introduction

Thank you for selecting a Canon autofocus SLR camera.

EOS REBEL II/REBEL SII, developed as Canon's new standard model autofocus SLR camera, is a compact EOS SLR offering quiet film transport and motor operation. Features such as simple dial operation and super-fast autofocus make it easier than ever to take great pictures any time.

EOS REBEL II/REBEL SII employs AI Focus, which automatically switches between One-shot AF and AI Servo AF* based on the subject's movement. As a result, accurate focusing can be obtained even when the subject is moving toward or away from the camera.

- * One-shot AF: Focusing stops once completed. The original focus remains locked as long as the shutter button is kept pressed halfway.

AI Servo AF: An advanced autofocus mode which continuously focuses moving subjects as long as the shutter button is kept pressed halfway.

- The instructions in this book assume use of the EF 35-80 mm f/4-5.6 zoom lens; however, operations with a different lens are basically the same.

Please read this instruction book carefully for a thorough understanding before using your EOS REBEL II/REBEL SII.

Attention

IMPORTANT INFORMATION

The Canon EOS REBEL II/REBEL SII will give optimum performance together with specially designed Canon EF lenses, flash units and other Canon brand accessories. It is possible that the use of incompatible lenses or other accessories may result in unsatisfactory performance or damage to your Canon EOS REBEL II/REBEL SII. We therefore suggest the use of Canon EF lenses and accessories. Damage to your Canon EOS REBEL II/REBEL SII as a result of malfunction or improper connections caused by the use of incompatible products may void its warranty.

While reading these instructions, unfold the front and back flaps for easy reference to the camera's parts.



Nomenclature

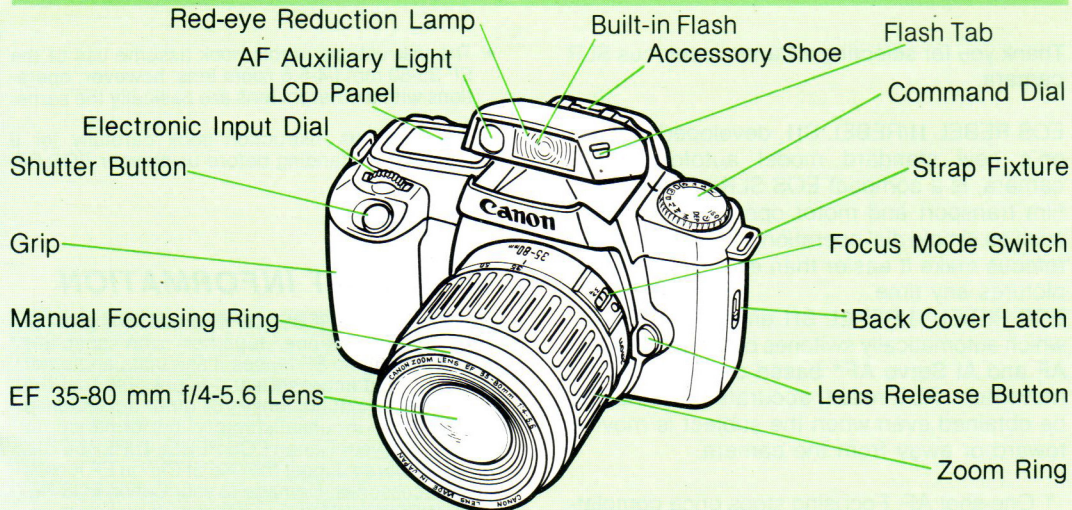

PROGRAMMED IMAGE CONTROL

- : Green Zone
- : Portrait
- : Landscape
- : Close-up
- : Sports

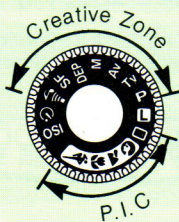

CREATIVE ZONE

- ISO : Manual Film Speed Setting
- : Self-timer
- : Sound Mode
- SF : Soft Focus
- DEP : Depth-of-Field AE

- M : Manual Exposure
- Av : Aperture-priority AE
- Tv : Shutter-priority AE
- P : Program AE
- : Lock (OFF)

Table of Contents

I. BASIC OPERATION

[1] Preparations	
1. Battery Load and Check	7
2. Lens Attachment	9
3. Focusing	10
- Difficult Subjects for Autofocus [Manual Focusing]	11
[2] Taking Pictures	
1. Film Loading	12
2. Basic Picture Taking - Green Zone	14
- Focus Lock	16
- Film Rewind	17
3. Programmed Image Control	18
- Portrait	18
- Landscape	19
- Close-up	19
- Sports	20

II. ADVANCED OPERATION

1. Creative Zone	22
P - Program AE	22
Tv- Shutter-priority AE	24
Av- Aperture-priority AE	25
M - Manual Exposure	26
DEP- Depth-of-Field AE	28
SF- Soft Focus	31
2. Self-timer	33
- Setting the Sound Mode	34
3. Flash Photography with the Built-in Flash	35
4. Flash Photography with the Speedlite 200E	38

III. APPLICATIONS

1. Partial Metering	42
2. Exposure Compensation	44
3. Multiple Exposures	45
4. Bulb (Long Exposure)	47
5. Manual Film Speed Setting	48

IV. REFERENCE

1. Comparisons Between AF Mode and Film Wind Mode	49
2. Film Shooting Capacity	50

V. ACCESSORIES

1. Dedicated Canon Speedlites	51
2. Grip Extension GR-70	52
3. Dioptic Adjustment Lenses	52
4. Lens Hoods	53
5. Filters	53

VI. CAMERA CARE

1. Cleaning	54
2. Liquid Crystal Display/Battery Notes	55
3. Attaching the Strap	57

VII. SPECIFICATIONS

Precautions

- 1) This camera is not resistant to water and should not be used outdoors in snow or rain. If accidentally dropped in water, contact an authorized Canon service facility. Keep the camera out of salt spray, and protect it from excessive humidity. If used at the beach, clean it thoroughly afterward with a dry cloth.
- 2) Do not attempt to disassemble the camera yourself. Always take it to an authorized Canon service facility for repair.
- 3) Remove the battery if you do not expect to use the camera for about three weeks or longer.
- 4) When storing the camera, wrap it in a clean, soft cloth and place in a cool, dry, dust-free place. Be sure to keep the camera out of direct sunlight, and away from "hot spots" such as the trunk or rear window shelf of a car. Avoid places where moth balls are used, and in extreme humidity, use a desiccant.
- 5) Carefully check the camera's operation after lengthy storage.
- 6) The battery may explode or cause burns if disassembled, recharged, shorted, exposed to high temperatures, or disposed of in fire.
- 7) Film passing through X-ray examinations at airports may be exposed and ruined even if loaded in the camera. Request a hand-checked inspection to avoid damage.
- 8) Aerosol spray dust removers are not recommended for the shutter curtain.
- 9) Condensation is a problem when bringing cold equipment into a warm room. If the autofocus optics cloud over, accuracy may be seriously affected. Before entering a warm room, put equipment in a plastic bag so condensation forms on the outside of the bag.
- 10) Color reproduction may be adversely affected if the film is left in the camera for a long time. Always develop exposed film promptly.

* Please see p. 54 for camera care information.

I. BASIC OPERATION

First-time SLR users should read this section carefully.

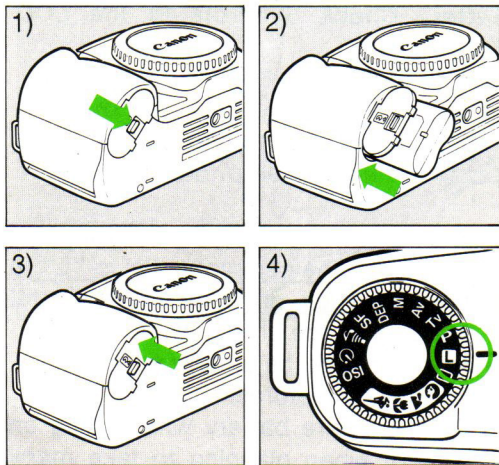

The camera operates on a 2CR5 lithium battery.

- 1) Slide the battery cover lock down to open. The cover cannot be removed from the camera.
- 2) Insert the battery as shown with the terminals facing toward the shutter button.
- 3) Close the cover and hold it down until it locks with a click.
- 4) Turn the command dial to “ P ” or “  ” to check the battery.

The battery check symbol () in the LCD panel displays the remaining battery power as shown in the illustrations.

- If nothing is displayed in the LCD panel, the battery is probably inserted upside down. Remove the battery and re-insert it correctly.
- See p. 55 for other important battery information.

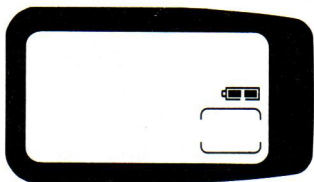

Battery Check Symbols in the LCD Panel

 : Battery power sufficient.

 : Have a new battery handy.

 : Replace the battery.

 (blinking): See p. 56.

- When not using the camera, always be sure to set the command dial to "L" to prevent battery drain due to accidental pressing of the shutter button.
- Always check the battery condition before taking pictures.
- Carry a spare battery when going on trips or when planning to take many pictures.
- See p. 50 for shooting capacity.

2. Lens Attachment

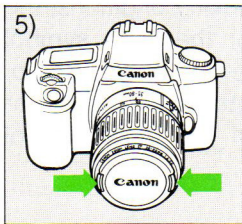
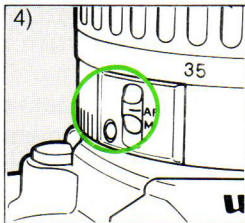
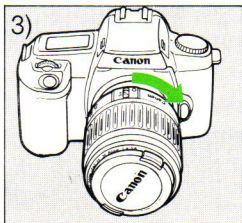
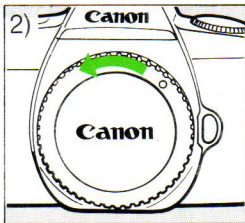
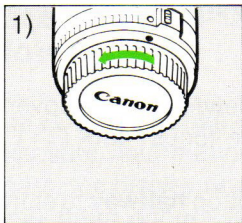

- 1) Remove the rear lens cap by turning it counterclockwise.
- 2) Remove the body cap by turning it counterclockwise.

The lens may already be mounted on the camera when purchased.

- 3) Align the lens' red dot to the camera's red dot and turn the lens clockwise until it stops and locks with a click.
 - **To remove the lens**, turn the lens counterclockwise while pressing the lens release button.
- 4) Set the lens' focus mode switch to AF.
- 5) Remove the front lens cap.

- The electronic contacts must be clean for proper connection. **Do not touch** these contacts.
- Do not set the lens on its rear end without the lens cap attached to prevent damage to the electronic contacts.

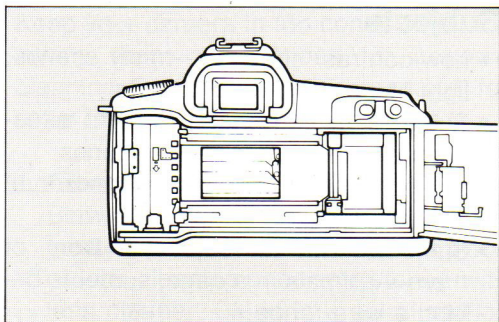

- Always load film out of direct sunlight.
- **Never touch the shutter curtain.** Its precision design makes it sensitive to pressure. When loading film, be careful that the film tip does not touch the shutter curtain.

This camera uses a prewind system. When film is loaded, the camera first winds all of the film onto the take-up spool and then rewinds it back into the film cartridge one frame at a time as each picture is taken. The frame counter on the LCD panel decreases as pictures are taken, allowing you to always see at a glance the remaining frames.

For DX-coded film, the camera automatically sets the film speed when the film is loaded. (For manual film speed setting, see p. 48.)

3. Focusing



Before practicing, set the command dial to “□” (Green Zone).

- 1) Look through the viewfinder and cover the subject with the focus mark (□).
- 2) Press the shutter button **halfway** to start focus. When the subject is in focus, the green AF symbol “●” lights up in the viewfinder.
- 3) Without letting up on the shutter button, press the shutter button completely to take the picture.
 - In low-light or backlit conditions, the shutter speed or the flash symbol “⚡” blink in the viewfinder. See p. 15 when the shutter speed blinks or see p. 35 when the flash symbol “⚡” blinks.

Difficult Subjects for Autofocus [Manual Focusing]

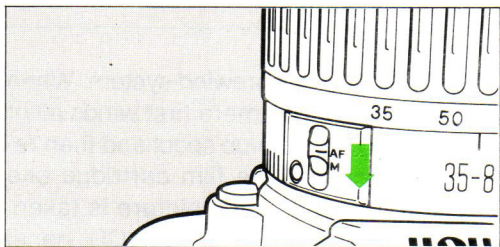
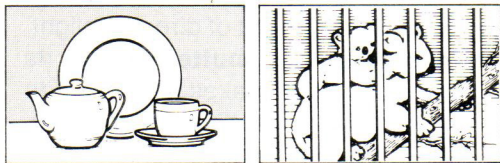

There are a few subjects that may be difficult for the camera to focus. The green AF symbol will blink in the viewfinder to warn you of this condition.

Subjects

- Low-contrast subjects—misty scenes, light-colored or white objects.
- Subjects in extremely low-light situations—a dark room, night scenes.
- Subjects having generally horizontal patterns (window blinds).
- Subjects with an object in front of them—animals in a cage, subjects behind a wire fence.
- Strong, bright reflections—shiny metal, ice, surface of a lake.
- Fast-moving subjects—difficult to keep within the focus mark.

Focus these subjects by setting the lens' focus mode switch to "M" and turning the manual focusing ring until the image is sharp.

1. Film Loading

[2] Taking Pictures

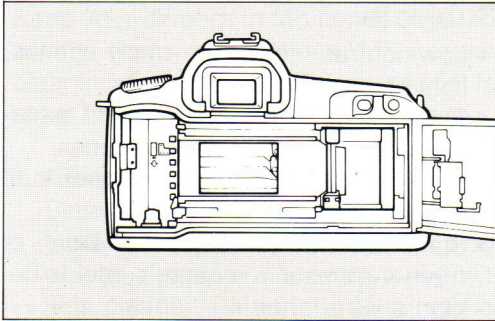

- Always load film out of direct sunlight.
- **Never touch the shutter curtain.** Its precision design makes it sensitive to pressure. When loading film, be careful that the film tip does not touch the shutter curtain.

This camera uses a prewind system. When film is loaded, the camera first winds all of the film onto the take-up spool and then rewinds it back into the film cartridge one frame at a time as each picture is taken. The frame counter on the LCD panel decreases as pictures are taken, allowing you to always see at a glance the remaining frames.

For DX-coded film, the camera automatically sets the film speed when the film is loaded. (For manual film speed setting, see p. 48.)

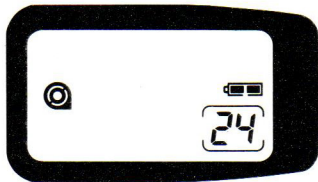
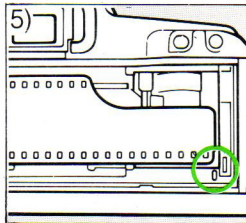
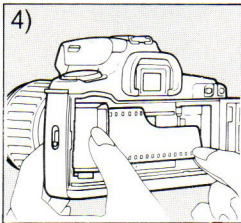
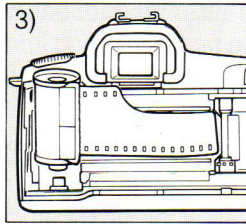
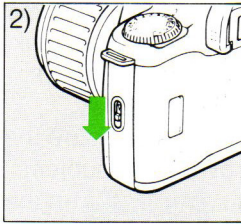

- 1) Make sure the command dial is not at L.
- 2) Open the back cover by sliding the latch down.
- 3) Insert the film as shown with the flat end of the cartridge on top.
- 4) Carefully pull the film tip across until it reaches the orange mark.
- 5) Make sure the film lies flat and close the back cover.



Film winding starts and the frame counter counts up. When the film is completely wound, the shutter is released once; however, no picture is taken. The film cartridge symbol and the number of available frames are displayed in the LCD panel.

- If the film cartridge symbol blinks, the film has not been loaded properly and the shutter will not release. Reload the film.
- Film becomes soft and tears easily in high humidity. Keep it stored in its canister until loading.

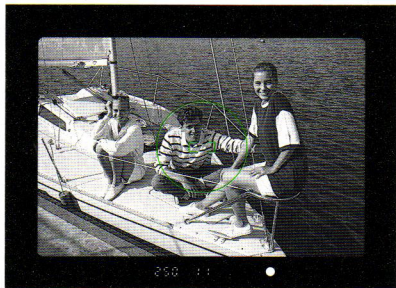
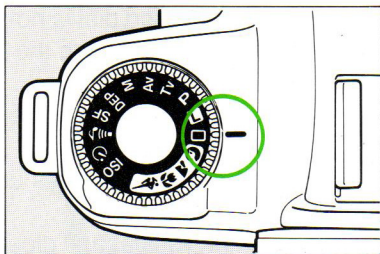
2. Basic Picture Taking - Green Zone



This setting for basic operation allows you to begin shooting immediately without making any settings before taking pictures.

- 1) Set the command dial to "  "
- 2) Compose the picture and make sure the focus mark () covers the subject.
 - If you are using a zoom lens, turn the zoom ring to vary the size of the subject.
- 3) Press the shutter button halfway.

When the subject is in focus, the green AF symbol, shutter speed and aperture value light up in the viewfinder. Press the shutter button all the way down to take the picture.

 - The shutter speed and aperture value are also displayed in the LCD panel.
 - In low light or backlit conditions, the "  " mark blinks in the viewfinder. Switch to flash photography (see p. 35) or use a tripod.



Blinking shutter speed (camera shake warning)

In Green Zone and Programmed Image Control modes, the shutter speed will blink on the LCD panel and in the viewfinder if the shutter speed is too slow to hand-hold. In this case, we recommend switching to flash photography or using a tripod.

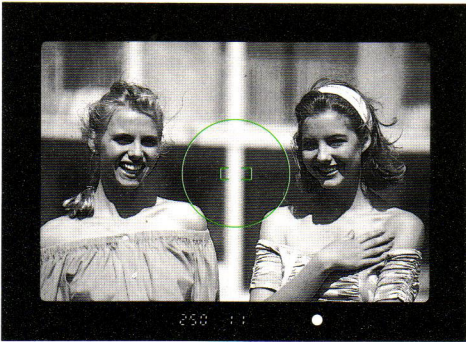
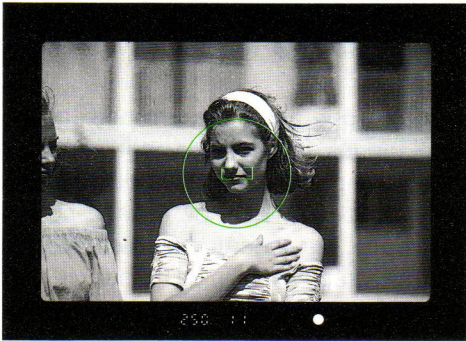

Focus Lock

This camera focuses on the subject covered by the focus mark in the center of the viewfinder. For off-center subjects, use focus lock to set the focus and then recompose the picture as desired.

- 1) Cover the subject with the focus mark and press the shutter button halfway.
- 2) Keeping the shutter button pressed halfway, recompose the picture as desired and then press the shutter button all the way down to take the picture.

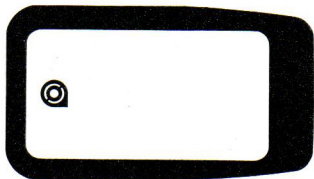

Film Rewind

When the last picture is taken, the remaining film automatically rewinds into the cartridge. When completed, rewinding stops and the film cartridge symbol blinks in the LCD panel.

If you want to develop the film before the end of the roll, remove the lens and turn the command dial to "ISO". Press both the exposure compensation button and the partial metering button simultaneously.

Caution

- If the back cover is opened before the end of the roll is reached and the film is forcefully pulled out of the camera without first being rewound according to the above procedure, be sure to close the back cover and release the shutter once before loading another roll of film.
- If a new roll of film is loaded without first closing the back and releasing the shutter, the film leader will be rewound completely into the cartridge when the back cover is closed.

3. Programmed Image Control (P.I.C.)

With P.I.C., focus and film wind settings as well as shutter speed and aperture value settings are made automatically for four types of pictures: portraits, landscapes, close-ups, and sports. This allows you to take pictures easily and concentrate on composition.

- If the “ ⚡ ” mark blinks in the viewfinder, switch to flash photography or use a tripod.
- If the shutter speed blinks to warn of camera shake, we recommend switching to flash photography or using a tripod.

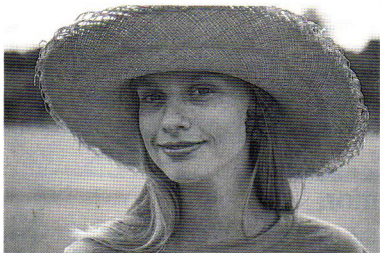

Portrait Settings: One-shot AF/Continuous wind/Evaluative metering

Shallow depth of field is generally used to emphasize the subject, therefore large apertures (small numbers) are set. Focus on the subject's eyes. Continuous film wind helps keep up with the subtle changes in expression.

For effective background blur, separate the subject from the background as much as possible and use a telephoto lens or the telephoto setting on your zoom lens (80 mm on the EF 35-80 mm f/4-5.6).



Landscape Settings: One-shot AF/Single frame wind/Evaluative metering

Deep depth of field is usually the primary concern in landscape photography. This setting automatically sets small apertures (large numbers) for deep depth of field.

Use a wide-angle lens or the wide-angle setting on your zoom lens to create a feeling of expansiveness and depth.

Close-up Settings: One-shot AF/Single frame wind/Partial metering

Move as close as possible to the subject for the maximum magnification. When using a zoom lens, you can achieve maximum magnification by setting the lens to the telephoto position.

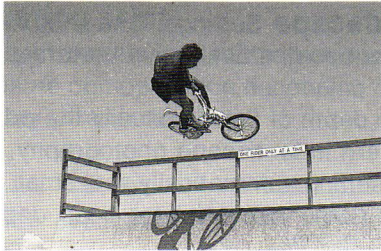

 **Sports** Settings: AI focus AF/Continuous
wind/Evaluative metering

Faster shutter speeds are emphasized to help you keep up with all the action while AI servo tracks the subject's movement. Keep the focus mark on the subject.

- Continuous shooting is possible by holding the shutter button down.

II. ADVANCED OPERATION

1. Creative Zone

The command dial's "Creative Zone" provides six shooting modes, enabling you to select the mode and values which best match your subject and photographic objectives. Also, with "Creative Zone" modes, you can use functions such as **exposure compensation** and **multiple exposure** (explained in the Applications section) to further expand your creativity.

Select the desired mode by turning the command dial.

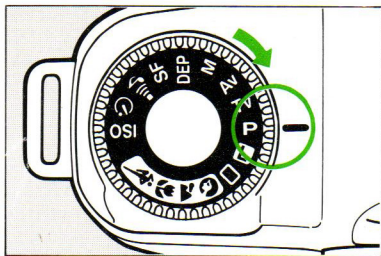

P: Program AE Settings: AI focus AF/Continuous wind/Evaluative metering
The camera sets both aperture and shutter speed automatically, taking into account the lens in use.



Checking the Exposure

If the exposure data blink, the exposure is not correct. Use a flash in low light situations or use an ND (neutral density) filter in bright situations.

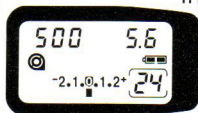

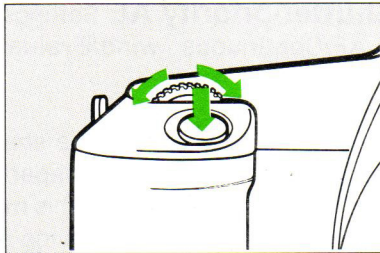

In the Creative Zone, an **exposure level scale and exposure level mark** appear in the viewfinder and LCD panel in addition to the exposure data (shutter speed and aperture value). The exposure level mark indicates the amount of exposure compensation in the four AE modes.

Program Shift

In Program AE mode, the automatically set shutter speed and aperture combination (program) can be changed while maintaining the same exposure.

To shift the program, press the shutter button halfway to display the exposure data and turn the electronic input dial to select the desired shutter speed or aperture value.

- Program shift is not possible when using a flash.

Six-second Timer

Even if you release the shutter button after pressing it down halfway, the exposure data (shutter speed and aperture) in the viewfinder and LCD panel appear for about six seconds.

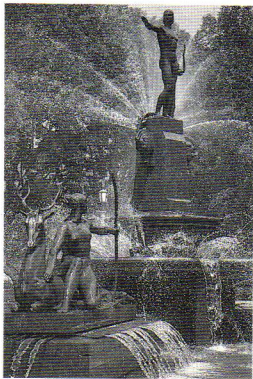

Tv : Shutter-priority AE Settings: All focus AF/Continuous wind/Evaluative metering

In this mode the user selects the shutter speed and the camera sets the aperture value for the lighting conditions. This mode is best for taking pictures of moving subjects by controlling the shutter speed. Faster shutter speeds freeze subject motion, while slower shutter speeds can produce artistic blur effects.

- The initial shutter speed setting is always 125 (1/125). Turn the electronic input dial for the desired shutter speed.

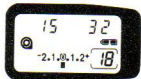
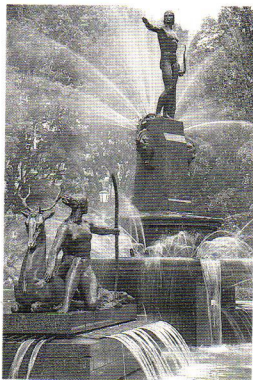

Checking the Exposure

Underexposure - The lens' maximum aperture starts blinking. Set a slower shutter speed until it stops blinking.

Overexposure - The lens' minimum aperture starts blinking. Set a faster shutter speed until it stops blinking.

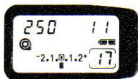
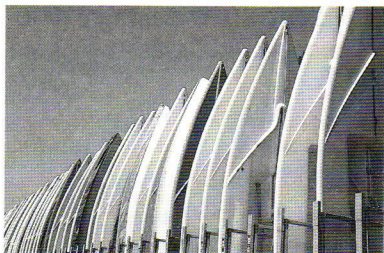

Av: Aperture-priority AE Settings: AI focus AF/Continuous wind/Evaluative metering

In this mode the user selects the aperture value and the camera sets the correct shutter speed for the lighting conditions. Use this mode for taking portraits, landscapes, and still life photography where depth of field is an important factor. Larger apertures produce a shallow depth of field appropriate for portraits, and smaller apertures produce a deep depth of field desirable for landscapes.

- The initial aperture value setting is always 5.6 (f/5.6). Turn the electronic input dial for the desired aperture value.

Checking the Exposure

Underexposure - The shutter speed of 30'' (30 sec.) blinks. Set a larger aperture until the shutter speed stops blinking.

Overexposure - The shutter speed of 2000 (1/2000 sec.) blinks. Set a smaller aperture until the shutter speed stops blinking.

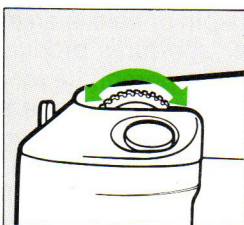
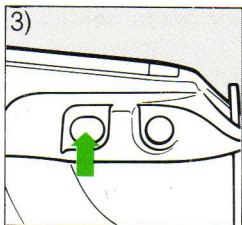
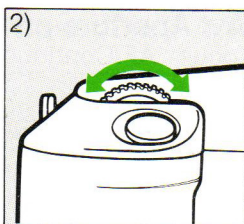
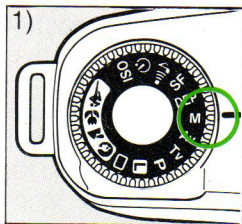

M: Manual Exposure Settings: All focus AF/Continuous wind/Center-weighted average metering.

This creative mode allows you to completely control exposure by setting both the shutter speed and aperture value.

The initial setting is always 1/125 sec. at f/5.6.

- 1) Set the command dial to “**M**” and turn the electronic input dial to set the desired shutter speed.
- 2) While pressing the exposure compensation button, turn the electronic input dial to set the desired aperture value.
- 3) Press the shutter button halfway and check the exposure data.
 - , or is displayed in the viewfinder and LCD panel to indicate the exposure.

Adjust the exposure according to the exposure indicator.



Metered standard exposure: The current settings will result in a correct exposure.



Overexposure: Close the aperture or set a faster shutter speed until correct exposure is obtained.



Underexposure: Open the aperture or set a slower shutter speed until correct exposure is obtained.



DEP: Depth-of-Field AE Settings:
One-shot AF/Single frame wind/Evaluative
metering

Depth-of-Field AE mode places everything
between user set points in the foreground
and background in focus. The points are
set using the focus mark in the viewfinder.

The camera sets the necessary aperture
value and shutter speed to obtain the best
possible results under the existing lighting.

*** This mode cannot be used with flash.**

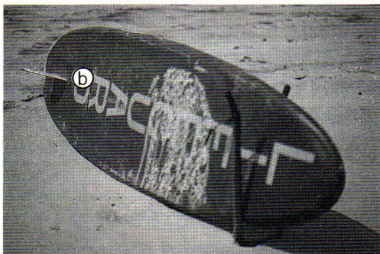

- 1) Set the command dial to "DEP".
- 2) Place the focus mark on the first point (a) and press the shutter button halfway.
 - Remove your finger when the green AF symbol and "dEP 1" light up in the viewfinder.
- 3) Repeat step #2 for the second point (b); "dEP 2".
- 4) Recompose the picture and press the shutter button halfway. After the AF symbol and exposure data light up, press the shutter button completely to take the picture.

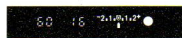

Checking the Exposure

- If the minimum aperture value of the lens in use blinks, clear the focus points by turning the command dial to another position and returning it to DEP. Move back from the subject or switch to a wide-angle lens or zoom lens' wide-angle setting and repeat steps #2 through 4. When the aperture value stops blinking, the distance range will be sharply focused and correct exposure will be obtained.
- If both the shutter speed and the aperture value blink, the exposure is not correct. Use an ND filter in bright situations. The flash can not be combined with this mode.

Additional Information

- To cancel Depth-of-Field AE in mid-operation, set the command dial to another position.
- When using a zoom lens, do not change the focal length after setting the first point. Always set the focal length first.
- Wide-angle lenses are best used in this mode for maximum depth-of-field effect. Lenses with a focal length longer than 200 mm are not recommended for deep depth of field.
- This mode can also be used to minimize depth of field by focusing on the same point both times. A telephoto lens gives portraits the best shallow depth-of-field effect.
- If the focus points are extremely near and far, the shutter speed may be very slow. We recommend using a tripod.

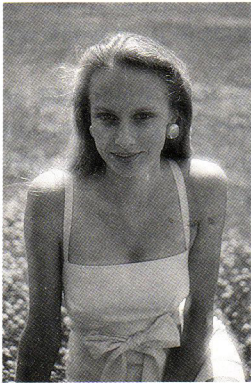
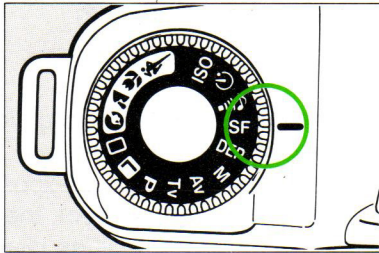

SF: Soft Focus

Soft Focus mode renders the subject with a soft, dreamlike effect for attractive portraits and picturesque landscapes. The camera automatically takes a double exposure with the first exposure in focus and the second providing the soft focus effect.

- The strength of the soft focus effect can be set to either “weak” (“1” in the LCD panel) or “strong” (“2”) by operating the electronic input dial.
 - If the lens' focus mode switch is set to “M”, pictures are taken in normal Program AE mode.
 - Aperture values are not displayed in the viewfinder or in the LCD panel during this mode.
- 1) Set the command dial to “SF”.
 - Change the soft focus strength if desired.

2) Press the shutter button halfway, confirm the shutter speed and soft focus value, then press completely to take the picture.

- The shutter speed for the second exposure of the double exposure and the soft focus value are displayed in the LCD panel and viewfinder.
- When the shutter button is pressed completely to take the picture, the shutter speeds for the first and second exposures are displayed in sequence in the LCD panel.
- When using flash, the flash fires for the first exposure only.
- The soft focus effect may not be obtained when using flash.

Exposure confirmation

If the soft focus value blinks, the desired soft focus effect will not be obtained, but the exposure will be correct. To obtain a good soft focus effect, use a telephoto lens or move farther from the subject.

For effective soft focus pictures—

- Zoom the lens to the telephoto side or use a long-focal-length lens.
- Since the camera takes two exposures to create the soft focus effect, the subject should remain as still as possible until the picture is over.
- For portraits, soft focus 1 (weak) is usually best. Also, avoid bright single-tone backgrounds (e.g., a white wall) for best effect.
- When using a lens equipped with a shooting distance range switch such as the EF 300 mm f/4 L, do not specify a distance range.

2. : Self-timer

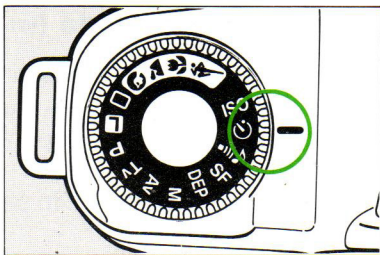

 : **Self-timer** Settings: One-shot AF/Evaluative metering

Use the self-timer function to delay shutter release for 10 seconds and include yourself in the picture. Place the camera on a tripod, table, or other steady surface.

- Shooting mode is automatically set to Program AE.

- 1) Set the command dial to “  ”.
- 2) Compose the picture and press the shutter button to start the timer **while looking into the viewfinder**. A beeper tone sounds to monitor the countdown. Two seconds before the picture is taken, the beeper tone sounds rapidly.
 - Be careful **not to stand in front of the camera** when you press the shutter button.
 - To cancel the self-timer, turn the command dial to another position.

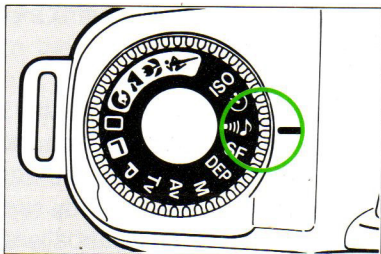

Setting the Sound Mode (🎵)

This function lets you select one of four sound settings (including three musical tunes) to play during self-timer operation.

- 1) Set the command dial to 🎵.
- 2) Turn the electronic input dial to set the desired sound number.
 - You can listen to the selected sound by pressing the shutter button when the sound number is displayed.

Sound Setting

- “1”: Electronic beeper
 - “2”: Vivaldi’s “Four Seasons—Spring”
 - “3”: Beethoven’s “Turkish March”
 - “4”: Bach’s “Minuet”
- * During self-timer operation when 2, 3 or 4 is selected, the tune plays for 9 seconds and then the beeper beeps rapidly for 1 second before the picture is taken.

3. Flash Photography with the Built-in Flash (REBEL SII only)

When the "⚡" mark blinks in the viewfinder, pull the built-in flash up manually for flash photography.

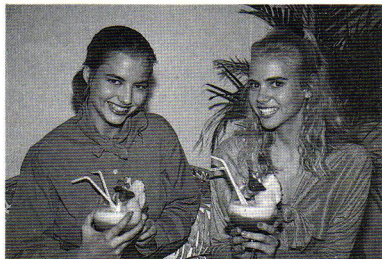

Notes

- 1) Always pull the flash up **gently** by grasping the flash tabs.
- 2) When not in use or when using an external flash, push the built-in flash down **gently** to retract. An external flash **cannot** be used together with the built-in flash.
- 3) For flash photography, do not press the shutter button completely until the "⚡" mark lights steadily in the viewfinder.

Flash Shooting Distance Range

(when using the EF 35-80mm f/4-5.6)

	WIDE		TELE	
ISO	Color Print Film	Slide Film	Color Print Film	Slide Film
100	0.7 - 5 m 2.3 - 16.4 ft	1 - 3.5 m 3.3 - 11.5 ft	0.7 - 3.5 m 2.3 - 11.5 ft	1 - 2.5 m 3.3 - 8.2 ft
400	0.7 - 10 m 2.3 - 33 ft	1.5 - 7 m 4.9 - 23 ft	1 - 7 m 3.3 - 23 ft	1.5 - 5 m 4.9 - 18.1 ft

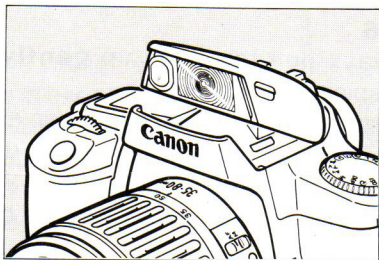

- 4) “” will not blink in the “Creative Zone”.
- 5) In low-light conditions, the built-in AF auxiliary light is emitted automatically if necessary when the shutter button is pressed halfway.
- 6) Using the following large-diameter lenses may cause shading at the lower part of flash photos:
 - EF 200 mm f/1.8 L
 - EF 300 mm f/2.8 L
 - EF 20-35 mm f/2.8 L
 - EF 28-80 mm f/2.8-4 L
 - EF 80-200 mm f/2.8 L
 - EF 50-200 mm f/3.5-4.5
 - EF 50-200 mm f/3.5-4.5 L
- 7) Using a lens of a focal length shorter than 35 mm may cause shading around the edges of flash photos.
- 8) To prevent shading, do not use a lens hood when using the built-in flash.

Flash Photography and the Red-eye Reduction Function

The subject's eyes may appear red in flash photos due to light reflected from the retina. This phenomenon is called "red eye." To minimize red eye, this camera automatically activates its built-in red-eye reduction function in Ⓢ (Self-timer) mode, □ (Full Auto) mode and 👤 (Portrait) mode when using flash in a situation where red-eye is likely to occur. In this mode, a lamp in the flash lights momentarily to reduce the size of the subject's pupils before the flash fires. When the shutter button is pressed halfway, the viewfinder display blinks for 2 seconds and the red-eye reduction lamp lights. When the viewfinder display stops blinking, press the shutter button all the way to take the picture.



Entire viewfinder display blinks.
(Internal viewfinder display)

- The red-eye reduction lamp lights continuously while the shutter button is pressed halfway.
- Have the subject look at the red-eye reduction lamp for best effect. The red-eye reduction effect differs depending on the subject and shooting conditions.
- The red-eye reduction lamp goes out if you remove your finger from the shutter button without taking a picture.

Light from the built-in flash will be blocked by the lens barrel at distances between 0.37 m (the closest shooting distance of the EF 35-80mm f/4-5.6 lens) and 0.7 m.

When using flash, always keep at least 0.7 m away from the subject.

4. Flash Photography with the Speedlite 200E (may be optionally available in some areas)

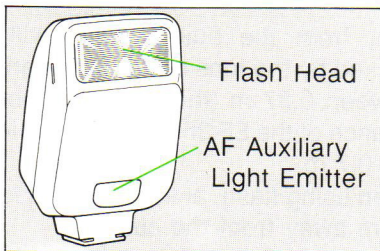
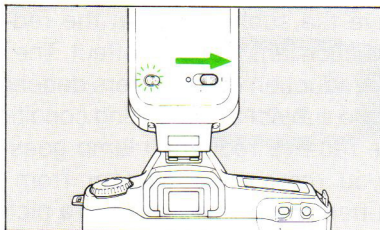
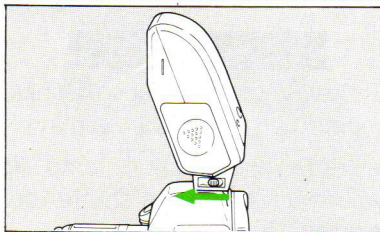

When the “⚡” indicator blinks in the viewfinder, attach the Speedlite 200E to the accessory shoe before taking pictures.

- After attaching the Speedlite 200E to the accessory shoe, slide the lock switch in the direction of the arrow to secure the flash to the camera.
- The “⚡” indicator does not blink in creative zone modes.

1) Set the Speedlite 200E's main switch to “I”. The ready lamp lights up when flash charging is completed.

- The viewfinder's “⚡” indicator also lights up when flash charging is completed.

2) Compose the picture and press the shutter button to take the picture.

- For flash pictures, do not press the shutter button completely until the flash unit's ready lamp lights up.

* For details, refer to the instructions provided with the Speedlite 200E.

Viewfinder Information When Using Flash

Shooting mode	Warning display	Condition	Note
(P) Program AE	During daylight fill-in flash photography, the lens' minimum aperture value blinks.	The background is overexposed.	The subject is correctly exposed.
(Tv) Shutter-priority AE	The lens' minimum aperture value blinks.	The background is overexposed.	The subject is correctly exposed. Blinking may stop if a faster shutter speed is set.
	The lens' maximum aperture value blinks.	The background is underexposed.	The subject is correctly exposed. Blinking may stop if a slower shutter speed is set.
(Av) Aperture-priority	The fastest possible x-sync shutter speed 90 (1/90 sec.) blinks.	The background is overexposed.	The subject is correctly exposed. Blinking may stop if a smaller aperture is set.
	The slowest shutter speed 30" (30 sec.) blinks.	The background is underexposed.	The subject is correctly exposed. Blinking may stop if a larger aperture is set.

X-sync Shutter Speed and Aperture Value

Shooting mode	X-sync shutter speed	Aperture value
Program AE	Automatically set to 1/90 sec.	Flash aperture value automatically set according to existing lighting and TTL program.
Shutter-priority AE	Manually set to any desired shutter speed of 1/90 sec. or slower*.	Aperture value automatically set according to the set shutter speed and existing lighting.
Aperture-priority AE	Automatically set between 30'' and 1/90 sec. according to the set aperture value and existing lighting.	Manually set to any desired aperture value.
Manual	Manually set to any desired shutter speed of 1/90 sec. or slower*.	Manually set to any desired aperture value.

* If the shutter speed is set to a value faster than 1/90 sec., the camera will automatically lower it to 1/90 sec.

III. APPLICATIONS

With these functions you can expand your creativity by tailoring the operation of your camera to match shooting conditions or your photographic objectives.

The functions described in the Applications section cannot be set in Green Zone or any of the P.I.C. modes.

1. Partial Metering



The main light metering system used in this camera is called “evaluative metering.” It evaluates the entire picture area by dividing it into three zones to determine the best exposure taking into consideration differences in brightness between the subject and background and the size of the subject. With a backlit subject, for example, the camera automatically compensates to obtain correct exposure for the main subject.

Partial metering, on the other hand, reads only **9.5%** of the center of the picture area. This is particularly suited for photography in theaters and other situations when there is a significant difference in brightness between the main subject and background. The exposure setting is automatically locked in partial metering mode, allowing you to freely recompose the picture after metering.



Partial Metering Area Mark

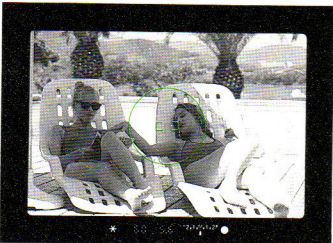
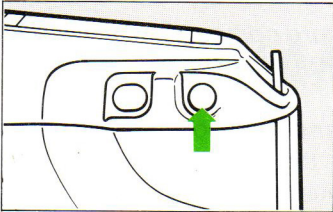

- 1) Compose the picture and focus the subject, then remove your finger from the shutter button.
- 2) Place the partial metering circle in the viewfinder on the subject you want metered and press the partial metering button. The partial metering mark “ * ” appears in the viewfinder. After “ * ” appears, press the shutter button halfway.
- 3) While pressing the shutter button halfway, recompose the picture if desired and press the shutter button completely.

Note:

You may remove your thumb from the partial metering button if you press the shutter button halfway after “ * ” appears in the viewfinder.

2. Exposure Compensation

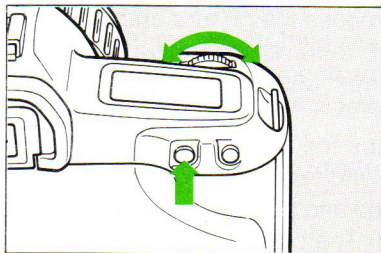

Use exposure compensation for intentionally underexposed or overexposed pictures. The compensation range is up to $+/- 2$ stops in half-stop increments. While pressing the exposure compensation button, turn the electronic input dial until the exposure level mark is set to the desired exposure compensation amount.

- *Exposure compensation remains active until canceled.*
- *To cancel* exposure compensation, repeat the above procedure to return the value to 0, or set the command dial to the green zone or to any of the P.I.C. modes.
- If you set an exposure compensation value before going into manual exposure mode, the manual exposure metering system will indicate the compensated value as the correct exposure.

3. Multiple Exposures

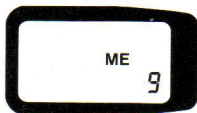
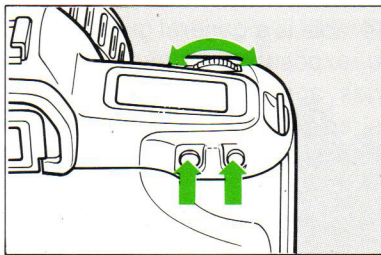

Try this function for creative and dramatic effects. Up to nine exposures can be made on the same frame with minimal operation.

- 1) Press the exposure compensation button and the partial metering button together to display "**ME**" in the LCD panel.
 - 2) Turn the electronic input dial to set the desired number of exposures.
 - 3) Press the shutter button to start.
- "**ME**" blinks in the LCD panel during multiple exposure operation.
 - The film winds to the next frame after the set number of exposures have been taken.
 - To clear preset exposures, repeat steps #1 and 2 to set the number of exposures to 1.

4. Bulb (Long Exposure)

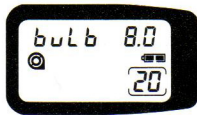
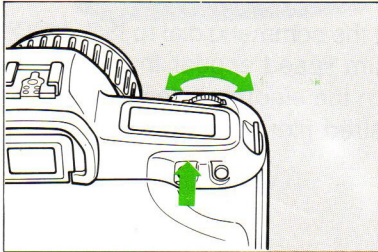
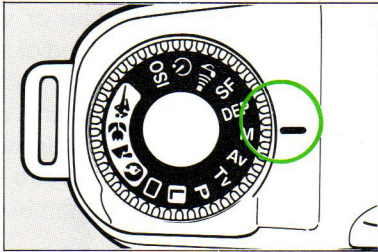

Use bulb for exposures longer than 30 seconds, such as for fireworks or night scenes. **The exposure continues as long as the shutter button is held down.** Make sure the camera does not move during exposure by placing it on a tripod or other steady surface.

- 1) Set the command dial to “M”.
 - 2) Turn the electronic input dial until “buLb” (after 30”) is displayed.
 - 3) Set the aperture value by turning the electronic input dial while pressing the exposure compensation button.
 - 4) Press the shutter button completely to take the picture.
- Bulb can be combined with the multiple exposure function.

IV. REFERENCE

1. Comparisons Between AF Mode and Film Wind Mode

Film wind mode	One-shot	AI Servo
Single	AF lock and AE lock in the evaluative metering mode take place simultaneously on AF completion. The shutter releases only after AF completion.	AF follows the subject and the exposure is determined at the moment of shutter release. The shutter releases only after AF completion.
Continuous	AF lock and AE lock in the evaluative metering mode take place simultaneously on AF completion, then continuous exposure is activated. (Approx. 1 fps maximum.)	AF follows the subject and the exposure is determined at the moment of shutter release. AF is adjusted to follow the subject during the series of exposure. (Approx. 1 fps maximum.) The shutter releases only after AF completion.

2. Film Shooting Capacity

The battery's shooting capacity varies depending on flash use and on the temperature of the environment. Refer to the table below.

Temperature	Without Flash	With 50% Flash	With 100% Flash
Normal (20°C)	75 rolls	30 rolls	12 rolls
Low (-10°C)	45 rolls	20 rolls	8 rolls

- Based on a new 2CR5 lithium battery using the EF 35-80 mm f/4-5.6 lens and 24-exp. film.
- Data are based on Canon's Standard Test Method.

V. ACCESSORIES

The accessories described in this section are sold separately.



1. Dedicated Canon Speedlites

If you need a flash with a little higher output than that of the built-in flash, attach the extra-compact and simple Speedlite 200E (guide number : 66 ·ft/20 ·m at ISO 100) to the camera. All you have to do is switch it on and point and shoot.

In addition to the **200E**, the powerful **430EZ** zoom flash with the maximum guide number of 141 ·ft/43 ·m (at ISO 100), and the **300EZ** with the maximum guide number of 98 ·ft/30 ·m (at ISO 100) are available. With the 430EZ in particular, advanced functions such as flash output level compensation, stroboscopic flash, second-curtain sync, bounce flash, and slow synchronization are possible in addition to large output. An external battery pack is also available for the 430EZ.

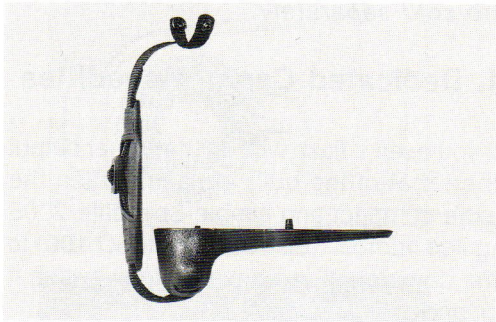

2. Grip Extension GR-70

The grip extension increases the size of the grip to provide a more comfortable and secure hold for large hands. An adjustable padded strap is included for easier handling. Fastens into the tripod socket with a lock nut screw.

3. Series E Dioptic Adjustment Lenses

For eyeglass wearers, there are 10 correction lenses available from +3 to -4 dpt. Conduct a test before purchase for the best match to your prescription and make viewing more comfortable.

* The numerical value printed on a dioptic adjustment lens indicates the diopter value obtained when the dioptic adjustment lens is attached to the camera. This number does *not* indicate the diopter value of the dioptic adjustment lens itself.



4. Lens Hoods

Use lens hoods to keep unwanted light from entering the lens. Select the right hood size to match your lens.

5. Filters

Use filters to cut unwanted light and provide special effects.

- Do not use more than one filter at the same time.
- When using a polarizing filter, be sure to use a Canon PL-C circular polarizing filter.

VI. CAMERA CARE

Keep your camera in top condition by following these suggestions for periodic cleaning. See the precautions on p. 5 for other important information.

1. Cleaning the lens surface—

Blow off dust with a blower brush and gently wipe the lens surface with a piece of lens cleaning paper moistened with lens cleaner. Clean in a spiral motion from the center outwards.

2. Cleaning mirror and focusing screen—

Use a blower brush reserved for this purpose only. If more cleaning is necessary, NEVER attempt to do it yourself. Take the camera to an authorized Canon service facility.

3. Cleaning the film chamber—

Use a blower brush to remove accumulated film dust particles that might scratch the film. Be careful NOT TO TOUCH the shutter curtain.

4. Cleaning the film pressure plate and film guide rails—

Lightly wipe the surface with a piece of lens cleaning paper moistened with lens cleaner. Be careful NOT TO TOUCH the shutter curtain.

- Use of aerosol spray dust removers is not recommended.

Liquid Crystal Display/Battery Notes

The LCD panel uses liquid crystal to show exposure information. After about five years, the display may become difficult to read. If this occurs, have it replaced at an authorized Canon service facility. Replacement is at the owner's expense.

Liquid crystal may also respond relatively slowly in temperatures below 32°F/0°C. It may also darken in temperatures around 140°F/60°C. The LCD panel will return when the temperature returns to normal.

Battery Information

Lithium Battery Check

Always check the battery at the following times:

1. When loading a new battery
2. After lengthy storage
3. Before an important shooting assignment
4. In cold weather
5. If the shutter will not release



Battery Use Information

1. Wipe the battery terminals with a clean, dry cloth to ensure proper connection.
2. Remove the battery if you do not expect to use the camera for more than three weeks.
3. Battery performance deteriorates slightly in temperatures below 32°F/0°C. Keep the camera and especially a spare battery close to your body or in an inside pocket to keep it warm until use.

4. The battery may explode or cause burns if disassembled, recharged, shorted, exposed to high temperatures, or disposed of in fire. Be sure to observe all precautions indicated on the battery package. Always keep it out of the reach of children.
5. If the battery check symbol blinks or does not appear in the LCD panel during battery check, exposure will be okay as long as the shutter releases. Film advance and rewind will be impaired by insufficient battery power. If wind or rewind stops due to the exhausted battery, the film cartridge symbol will blink. Film transport resumes after a new battery is loaded.

Blinking “” Display

There are two conditions when the blinking “” will appear in the LCD panel.

1. If the battery is nearly exhausted, the blinking “” will appear when the shutter button is pressed halfway or when the battery is checked.
2. If the remaining battery power does not show a replacement condition, but the camera’s self-test process detects an internal malfunction, the blinking “” will appear when the shutter button is pressed halfway.*
 - * In this case, remove the battery once. Wipe the battery terminals and reload it. Check the battery again. If the blinking “” still appears, the camera needs to be examined by an authorized Canon service facility.

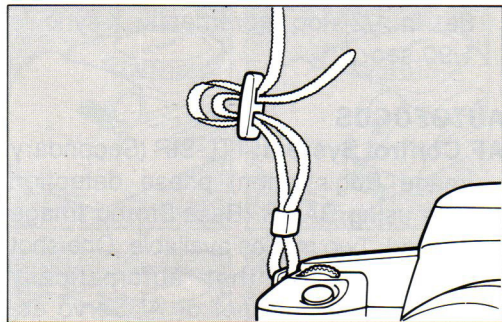

Attaching the Strap

Thread the ends of the neckstrap through the fixtures as shown.

VII. SPECIFICATIONS

TYPE AND MAJOR COMPONENTS

Type: 35 mm focal plane shutter SLR (single-lens reflex) autofocus/auto exposure camera, with built-in motor drive and flash.

Lens Mount: Canon EF mount (electronic signal transfer system)

Usable Lenses: Canon EF lenses

Viewfinder: Fixed eye-level pentaprism. Gives 90% vertical and horizontal coverage of actual picture area and 0.75X magnification with 50 mm lens at infinity.

Standard Diopter: Adjusted to -1.

Focusing Screen: Fixed, new laser-matte screen with focus mark and partial metering mark.

Shutter: Vertical-travel, focal plane shutter with all speeds electronically controlled.

Shutter Speed: 1/2000 - 30 sec. and bulb.

Set in 1/2-stop increments. X-sync is 1/90 sec.

AUTOFOCUS

AF Control System: TTL-SIR (Secondary Image Registration) phase detection type using BASIS (Base-Stored Image Sensor). Two modes available: One-shot and AI Focus that automatically switches to One-shot or AI Servo according to subject.

Manual focusing also possible.

AF Working Range: EV 1 - 18 at ISO 100.

AF Auxiliary Light: Automatically projected when necessary by the specified Speedlite.

EXPOSURE CONTROL

Light Metering: TTL full-aperture metering using an SPC (Silicon Photocell).

Three metering patterns available:

3-zone evaluative metering, partial metering which covers approx. 9.5% of the central picture area and center-weighted average metering (only when selecting the manual exposure mode).

Metering Range: EV 2-20 with 50 mm f/1.4 lens at ISO 100.

Shooting Modes:

1. Green Zone (Intelligent Program AE)
2. Programmed Image Control (Portrait, Landscape, Close-up, Sports)
3. Intelligent Program AE
4. Shutter-priority AE
5. Aperture-priority AE
6. Metered Manual
7. Soft Focus
8. Depth-of-Field AE
9. Flash AE (A-TTL or TTL program flash AE with the flash)

Camera Shake Warning: Operates in Green Zone and Programmed Image Control modes. Shutter speed blinks when automatically-set shutter speed is 0 to 0.5 steps slower than “1/focal length of the lens in use.”

Multiple Exposures: Up to nine exposures can be preset. Automatically clears upon completion.

Exposure Compensation: +/– 2 stops in 1/2-stop increments.

FILM TRANSPORT

Film Speed Setting: Automatically set according to DX code (ISO 25-5000) or set by user (ISO 6-6400).

Film Loading: Automatic prewind system. After film positioning and back cover closure, the film automatically winds to the end of the roll and stops.

Film Wind: Automatic. One of two modes is automatically set: Single Frame and Continuous (1 fps maximum).

Film Rewind: Automatic rewind at end of roll.

POWER SOURCE

Battery: One six-volt lithium battery (2CR5).

OTHER

Self-timer: Electronically controlled with a 10-sec. delay.

Sound Mode: Self-timer sound selectable from four settings—electronic beeper, Vivaldi's "Four Seasons—Spring", Beethoven's "Turkish March" and Bach's "Minuet".

DIMENSIONS

Size: 5-7/8" (W) × 3-13/16" (H) × 2-11/16" (D)

148 (W) × 99.8 (H) × 68 (D) mm

Weight: 14.1 oz. (410 g) without battery

15.5 oz (450 g) with battery

LENSES

		EF 35-80 mm f/4-5.6	EF 35-105 mm f/4.5-5.6
Angle of View	Diagonal	63° - 30°	63° - 23°30'
	Vertical	38° - 17°	38° - 13°
	Horizontal	54° - 25°	54° - 19°20'
Optical Construction	8 elements in 8 groups	13 elements in 12 groups	
Minimum Aperture	22-32	22-27	
Shooting Distance	1.2 ft/0.37 m-infinity	2.8 ft/0.85 m- infinity	
Maximum Magnification	35 mm	35 mm	
	0.12 (200 × 300mm)	0.054 (443 × 667mm)	
	7-7/8" × 11-13/16"	17-7/16" × 26-1/4"	
	80 mm	105 mm	
0.25 (96 × 144mm)	0.16 (150 × 224mm)		
3-3/4" × 5-11/16"	5-7/8" × 8-13/16"		
Filter Size	52 mm	58 mm	
Hood	EW-62	EW-68 B	
Case (hard/snap)	LH-C13/ES-C9	LH-B12/ES-C9	
Length × Max. Diameter	2-3/8" × 2-11/16" 61 × 68.6 mm	2-3/4" × 2-1/2" 70.6 × 63.3 mm	
Weight	6.3 oz. (180 g)	9.9 oz. (280 g)	

BUILT-IN FLASH

Type: Built-in TTL automatic flash. Manually retractable. Series control system.

Guide Number (ISO 100): 39•ft/14•m

Flash Coverage Angle: Covers the angle of view of a 35 mm lens

Recycling Time: Approx. 2 sec.

Flash Duration: 1 ms or less

Flash Control System: TTL automatic control by metering light reflected from the film plane.

Shooting Distance Range: 2.3-16.4 ft/0.7-5 m (Based on ISO 100 film. The shooting distance range changes according to film speed.)

AF Auxiliary Light: Automatically emitted when the shutter button is pressed half-way if necessary. Effective distance range: 3.3-13.1 ft/1-4 m

Power Source: Same as that of the body

All data are based on Canon's Standard Test Method.

Subject to change without notice.

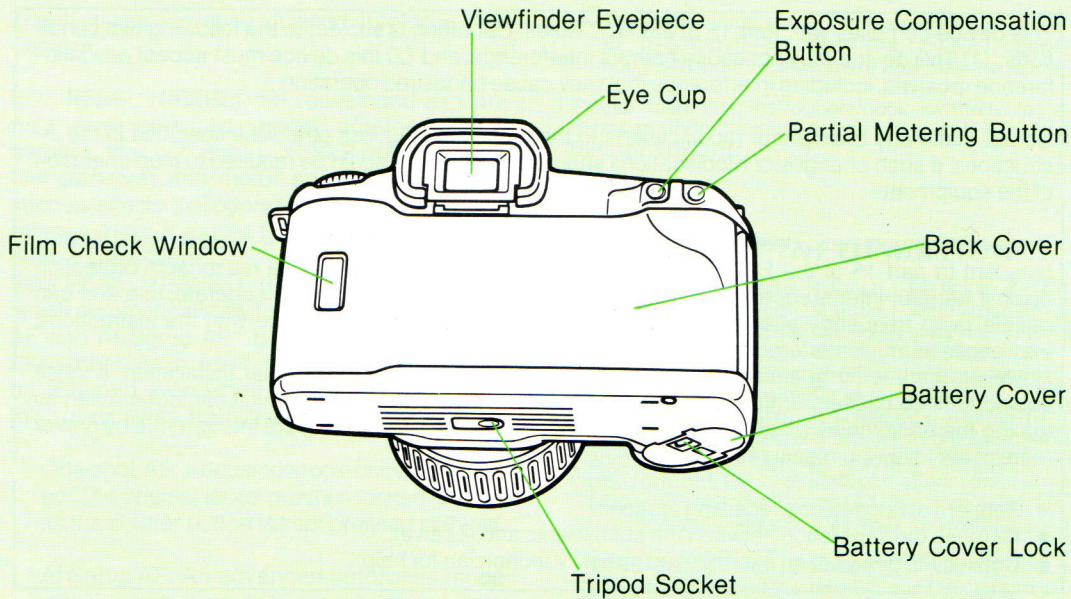

This device complies with Part 15 of the FCC Rules. Operation is subject to the following two conditions: (1) This device may not cause harmful interference, and (2) this device must accept any interference received, including interference that may cause undesired operation.

Do not make any changes or modifications to the equipments unless otherwise specified in the instructions. If such changes or modifications should be made, you could be required to stop operation of the equipments.

These equipments have been tested and found to comply with the limits for a class B digital device, pursuant to part 15 of the FCC Rules. These limits are designed to provide reasonable protection against harmful interference in a residential installation. These equipments generate, use and can radiate radio frequency energy and, if not installed and used in accordance with the instructions, may cause harmful interference to radio communications.

However, there is no guarantee that interference will not occur in a particular installation. If these equipments do cause harmful interference to radio or television reception, which can be determined by turning the equipments off and on, the user is encouraged to try to correct the interference by one or more of the following measures:

- Reorient or relocate the receiving antenna.
- Increase the separation between the equipments and receiver.
- Consult the dealer or an experienced radio/TV technician for help.

These digital apparatuses do not exceed the Class B limits for radio noise emissions from digital apparatuses set out in the Radio Interference Regulations of the Canadian Department of Communications.

Canon

CANON INC. 7-1, Nishi-Shinjuku 2-Chome, Shinjuku-ku, Tokyo 163, Japan
Mailing address: P.O. Box 5050, Dai-ichi Seimei Building, Tokyo 163, Japan

U.S.A. _____ **CANON U.S.A., INC. HEADQUARTERS**
One Canon Plaza, Lake Success, N.Y. 11042, U.S.A.
CANON U.S.A., INC. NEW JERSEY OFFICE
P.O. Box 1000, 100 Jamesburg Road, Jamesburg, New Jersey 08831 U.S.A.
CANON U.S.A., INC. WASHINGTON D.C. OFFICE
5701 General Washington Drive, Alexandria, Va. 22312, U.S.A.
CANON U.S.A., INC. CHICAGO OFFICE
100 Park Blvd. Itasca, Il. 60143-2693, U.S.A.
CANON U.S.A., INC. ATLANTA OFFICE
5625 Oakbrook Parkway, Norcross, Ga. 30093, U.S.A.
CANON U.S.A., INC. DALLAS OFFICE
3200 Regent Blvd., Irving, Tex. 75063-3145, U.S.A.
CANON U.S.A., INC. LOS ANGELES OFFICE
15955 Alton Parkway, Irvine, Ca. 92718, U.S.A.
CANON U.S.A., INC. SANTA CLARA OFFICE
2051 Mission College Blvd. Santa Clara, Ca. 95054-1509, U.S.A.
CANON U.S.A., INC. HONOLULU OFFICE
1020 Auahi St., Bldg. #8, Honolulu, Hawaii 96814, U.S.A.

CANADA _____ **CANON CANADA INC. HEADQUARTERS**
6390 Dixie Road, Mississauga, Ontario L5T 1P7, Canada
CANON CANADA INC. MONTREAL SERVICE CENTRE
10682 Côte de Liesse, Lachine, Quebec H8T 1A5, Canada
CANON CANADA INC. CALGARY OFFICE
2828, 16th Street, N.E. Calgary, Alberta T2E 7K7, Canada

EUROPE, AFRICA
& MIDDLE EAST _____ **CANON EUROPA N.V.**
Bovenkerkerweg 59-61, P.O. Box 2262, 1180 EG Amstelveen, The Netherlands
CANON PHOTO VIDEO FRANCE S.A.
"Le Doublet" 11, Avenue Dubonnet 92407 Courbevoie Cedex, France
CANON UK LTD.
Units 4 & 5, Brent Trading Centre, North Circular Road, London NW10 0JF, United Kingdom
CANON EURO-PHOTO G.m.b.H.
Siemensring 90-92, D-4156 Willich 1, Germany

CENTRAL &
SOUTH AMERICA _____ **CANON LATIN AMERICA, INC. DEPTO. DE VENTAS**
Apartado 7022, Panamá 5, República de Panamá
CANON LATIN AMERICA, INC. CENTRO DE SERVICIO Y REPARACION
Apartado 2019, Zona Libre de Colón, República de Panamá

SOUTHEAST ASIA _____ **CANON HONGKONG TRADING CO., LTD.**
10/F, Mirror Tower, 61 Mody Road, Tsimshatsui East, Kowloon, Hong Kong
CANON SINGAPORE PTE. LTD.
95 South Bridge Road #13-01, 15, Piedmont Centre, Singapore 0105

OCEANIA _____ **CANON AUSTRALIA PTY. LTD.**
1 Thomas Holt Drive, North Ryde, N.S.W. 2113, Australia
CANON NEW ZEALAND LTD.
Fred Thomas Drive, P.O. Box 33-336, Takapuna, Auckland, New Zealand

JAPAN _____ **CANON SALES CO., INC.**
12-15, Mitia, 3-Chome, Minato-ku, Tokyo 106, Japan