

WILSONWERKS ARCHIVES

This camera manual is for reference and historical purposes, all rights reserved.

This cover page is copyrighted material. This document may not be sold or distributed without the express consent of the publisher.

©2008 wilsonwerks Llc

Canon

CANON INC. 30-2, Shimomaruko 3-chome, Ohta-ku, Tokyo 146-8501, Japan

U.S.A. — **CANON U.S.A. INC.**

For all inquiries concerning this camera, call toll free in the U.S.
1-800-OK-CANON or write to: Customer Relations, Canon U.S.A., Inc.
One Canon Plaza, Lake Success, N.Y. 11042-1198

CANADA — **CANON CANADA INC. HEADQUARTERS**

6390 Dixie Road, Mississauga, Ontario L5T 1P7, Canada

CANON CANADA INC. MONTREAL BRANCH

5990, Côte-de-Liesse, Montréal Québec H4T 1V7, Canada

CANON CANADA INC. CALGARY OFFICE

2828, 16th Street, N.E. Calgary, Alberta T2E 7K7, Canada

For all inquiries concerning this camera, call toll free in Canada

1-800-OK-CANON

EUROPE, — **CANON EUROPA N.V.**

AFRICA & Bovenkerkerweg 59-61, P.O. Box 2262, 1180 EG Amstelveen, The Netherlands

MIDDLE EAST **CANON COMMUNICATION & IMAGE FRANCE S.A.**

102, Avenue du Général de Gaulle 92257 La Garenne-Colombes Cedex, France

CANON UK LTD.

Woodhatch Reigate Surrey RH2 8BF, United Kingdom

CANON DEUTSCHLAND GmbH

Europark Fichtenhain A10, 47807 Krefeld, Germany

CANON ITALIA S.p.A.

Palazzo L, Strada 6, 20089 Rozzano, Milanofiori, Milano, Italy

CANON Benelux N.V./S.A.

Bessenveldstraat 7, 1831 Diegem (Machelen), Belgium

CANON Schweiz AG

Geschäftsbereich Wiederverkauf, Industriestrasse 12, CH-8305 Dietlikon, Switzerland

CANON G. m. b. H.

Oberlaaerstrasse 233, 4th floor, 1100 Wien, Austria

CANON España, S. A.

C/Joaquin Costa, 41, 28002 Madrid, Spain

SEQUE Soc. Nac. de Equip., Lda.,

Praça da Alegria, 58, 2°, 1269-149 Lisboa, Portugal

CENTRAL & — **CANON LATIN AMERICA, INC. DEPTO DE VENTAS**

SOUTH AMERICA 703 Waterford Way Suite 400 Miami, FL 33126 U.S.A.

CANON LATIN AMERICA, INC. CENTRO DE SERVICIO Y REPARACION

Apartado 2019, Zona Libre de Colón, República de Panamá

ASIA — **CANON HONGKONG CO., LTD.**

9/F, The Hong Kong Club Building, 3A Chater Road, Central, Hong Kong

CANON SINGAPORE PTE. LTD.

79 Anson Road #09-01/06 Singapore 079906

OCEANIA — **CANON AUSTRALIA PTY. LTD.**

1 Thomas Holt Drive, North Ryde, N.S.W. 2113, Australia

CANON NEW ZEALAND LTD.

Fred Thomas Drive, P.O. Box 33-336, Takapuna, Auckland, New Zealand

JAPAN — **CANON SALES CO., INC.**

12-15 Mita, 3-Chome, Minato-ku, Tokyo 108-8011, Japan

This Instruction Booklet is current as of August 2000. For information on using this product with cameras introduced after this date, contact your nearest Canon Service Center.

CT1-1718-004

© CANON INC. 2000

PRINTED IN KOREA

Canon

SPEEDLITE 420EX



E

English Edition

INSTRUCTIONS

Thank you for purchasing a Canon product.

The Canon Speedlite 420EX is an autozoom flash unit equipped with a wireless sensor for E-TTL wireless autoflash.

* E-TTL stands for Evaluative-Through-The-Lens.

The features available with Speedlite 420EX depend on the EOS camera. Refer to the table below to identify your camera type. This instruction booklet has separate chapters for Type-A and Type-B EOS cameras. After reading the first chapter applicable to both camera types, read the respective sections that apply to your camera.

Type-A Camera	E-TTL	EOS-1D, 1V, 3, D60, D30, ELAN 7/7E, 30/33, ELAN II/ELAN II E, 50/50E, REBEL 2000/300, 500N/REBEL G, 3000N/66/REBEL XSN, IX, IX 7/IX Lite
Type-B Camera	TTL	All other EOS cameras other than the above.

Available 420EX Features with EOS Cameras

O: Available X: Not available.

Feature	With Type-A Cameras	With Type-B Cameras
E-TTL autoflash	O	X
TTL autoflash	X	O
High-speed sync (FP flash)	O	X
FE lock	O	X
E-TTL wireless autoflash with multiple Speedlites	O	X

Key to Symbols



The Caution symbol alerts you to actions to prevent flash photography problems.



The Note symbol gives additional information for basic operations.



The Light bulb symbol offers helpful tips for operating the Speedlite or for taking pictures.

Keep this instruction booklet handy for future reference.

Conventions Used in this Booklet

This instruction booklet has separate chapters for Type-A and Type-B cameras. If you have a Type-A camera, read pages 9 to 30 and 39 to 53.

If you have a Type-B camera, read pages 9 to 16 and 31 to 53.

- The operation procedures in this instruction booklet assume that the main (power) switch on the camera and 420EX has been turned on. Be sure to turn on the main switch before proceeding.
- The icons in the text indicate the camera and 420EX's buttons and dials and their settings. The icons in the text are the same ones found on the camera and Speedlite. For the name of the button or dial, see "Nomenclature" on page 8. The following icons for the camera's picture-taking modes are also used:
 - : Full Auto
 - : Program AE
 - : Aperture-priority AE
 - : Shutter speed-priority AE
 - : Manual
- The (16) icon indicates that the respective function remains in effect for 16 sec. after the relevant button is released.
- Reference page numbers are indicated in parentheses as follows: (→page ■)

Conventions Used in this Booklet.....3
Nomenclature.....6

1 Before You Start (For Type-A and Type-B Cameras)9

Installing the Batteries10
Mounting the Speedlite.....12
Wireless Selector13
Main Switch14
High-Speed Sync (FP Flash) Switch14
Pilot Lamp and Test Firing15
Flash Exposure Confirmation15
Flash Coverage16
AF-Assist Beam.....16

2 Easy Flash Photography (For Type-A Cameras)17

Flash in Full Auto Mode.....18
Flash in Other Picture-Taking Modes.....20
High-Speed Sync (FP Flash).....25
FE Lock27
Second-Curtain Synchronization.....29
Modeling Flash30

3 Easy Flash Photography (For Type-B Cameras)31

Flash in Full Auto Mode.....32
Flash in Other Picture-Taking Modes.....34

4 Advanced Flash Photography (For Type-A and B Cameras) ...39

Bounce Flash40
Flash Exposure Compensation41
Multi-Speedlite System.....42

Troubleshooting Guide48
Major Specifications49



Nomenclature

Front

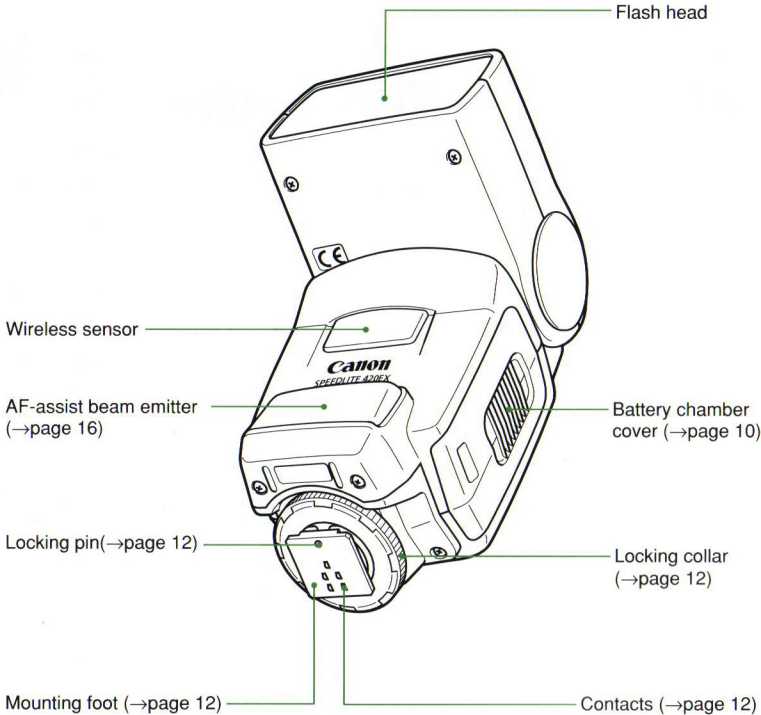

Back

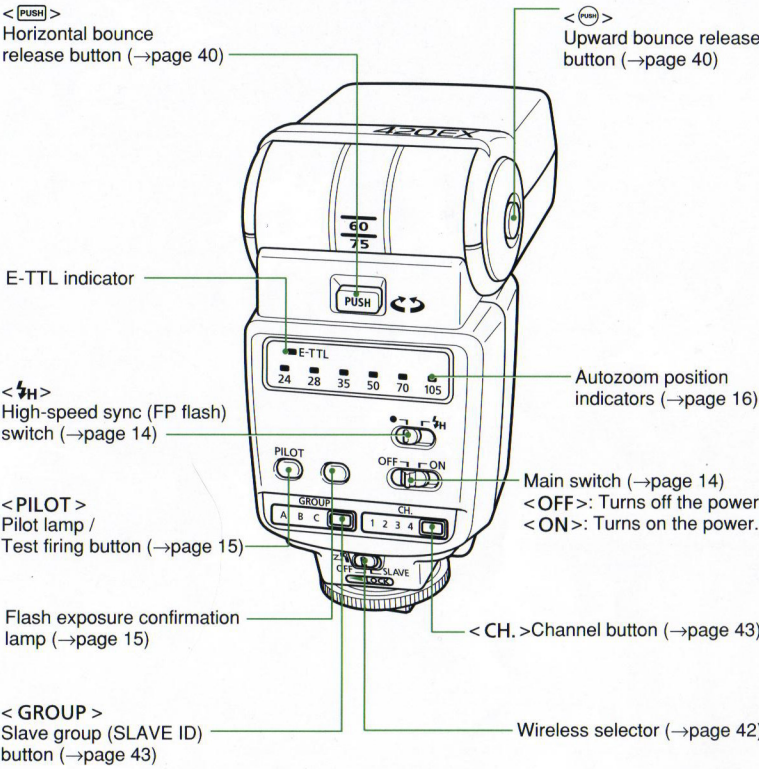

- The reference page is indicated by (→page ■).
- In the text, the 420EX's controls and settings are indicated with the corresponding icons enclosed in brackets < >.



This chapter helps you prepare for flash photography with the 420EX.

1

Before You Start

Installing the Batteries

Install one of the following types of batteries:

(1) Four size-AA alkaline batteries

(2) Four size-AA nickel-hydride batteries

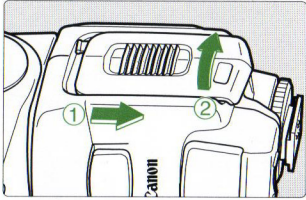

1 Open the battery chamber cover.

- Slide the battery chamber cover as shown by arrow 1 and flip it up as shown by arrow 2.

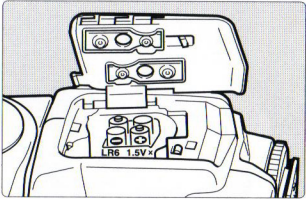

2 Insert the batteries.

- Make sure the + and - battery contacts are properly oriented as shown in the battery chamber.

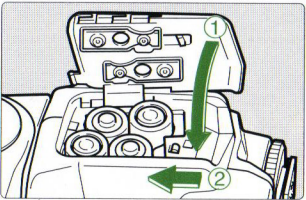

3 Close the battery chamber cover.

- Close the cover and push it down while sliding it as shown by arrow 2.



- Use four new batteries of the same type. When replacing batteries, replace all four batteries at one time.
- Size-AA lithium batteries can also be used.
- Although non-alkaline, manganese batteries may also be used, the number of flashes will be less.
- Remove the batteries when the 420EX will not be used for an extended period.
- In low temperatures, take two sets of batteries and keep one set warm in a pocket, etc., and use the batteries alternately.
- An external power pack cannot be used with the 420EX.



- To prevent faulty connections, make sure the battery contacts are clean. If necessary, use a clean cloth to wipe the battery contacts.
- In the case of size-AA nickel-hydride and size-AA lithium batteries, the shape of the contacts is not standardized. Be sure that the batteries are compatible with the flash unit before buying.

Recycling Time and Flash Count

Battery Type	Recycling Time	Flash Count
Size-AA alkaline batteries	Approx. 0.1-7.5 sec.	Approx. 200-1400

- The above specifications are based on Canon's testing standards.
- Using size-AA nickel-hydride batteries will yield only about 70 to 80 percent of the flashes (1550 mAh at full output) obtainable with size-AA alkaline batteries. The recycling time will also be about half the time with size-AA alkaline batteries.

Mounting the Speedlite

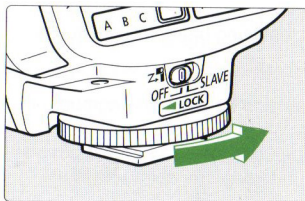

- 1 Loosen the locking collar.**
- Turn it as shown by the arrow.

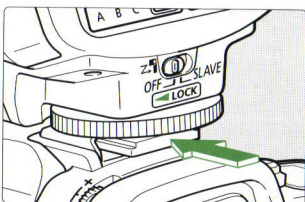

- 2 Mount the 420EX onto the camera.**
- Slide the 420EX's mounting foot all the way into the hot shoe.

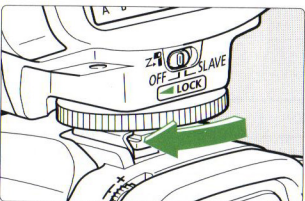

- 3 Tighten the locking collar.**
- Turn the locking collar as shown by the arrow. The mounting foot's locking pin extends into the hot shoe's locking pin hole.
 - To detach the 420EX, turn the locking collar in the opposite direction until it stops. (The locking pin retracts into the mounting foot.) Then slide out the 420EX from the hot shoe.

 The hot shoe on the EOS 650, 620, 750, and 850 does not have a locking pin hole. Although the 420EX can still be mounted on these cameras, be careful not to have it slip off the hot shoe.

Wireless Selector

The wireless selector has the following settings.

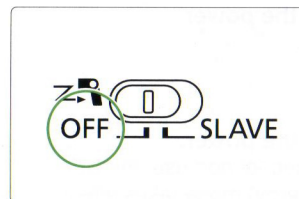

For Normal Flash Operation

- Set the wireless selector to OFF to use the 420EX as a normal, on-camera Speedlite.

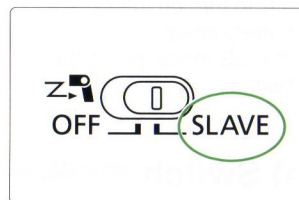

For Wireless Flash Operation

- Set the wireless selector to SLAVE to use the 420EX as a wireless slave unit.
- The flash coverage is set to 24mm automatically.

 Even if the wireless selector is accidentally set to <SLAVE>, the 420EX will still operate as an on-camera Speedlite for normal flash photography.

Main Switch

The main switch has the following settings.

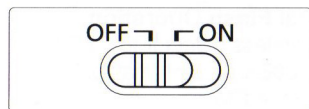

Turns off the power.

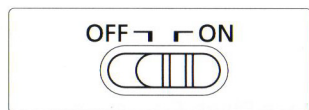

Turns on the power.

- After 90 sec. of non-use, the SE (Save Energy) mode takes effect automatically to turn off the 420EX and save battery power.
- To cancel the SE mode, press the test firing button.

High-Speed Sync (FP Flash) Switch

The high-speed sync switch has the following settings.

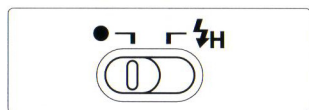

Sets the normal sync mode.

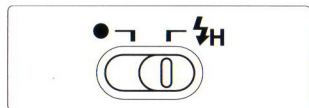

Sets the high-speed sync mode.

- When the 420EX is used with a Type-A camera and the switch is set to FH, setting a shutter speed faster than the camera's fastest sync speed sets the high-speed sync mode. And using a shutter speed slower than the fastest sync speed sets the normal sync mode.
- When a Type-B camera is used, the normal sync mode takes effect regardless of this switch's setting.

Pilot Lamp and Test Firing

Before taking the flash picture, you can fire a test flash.

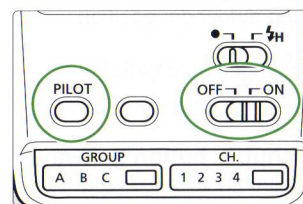

- 1 Check that the <PILOT> lamp is lit.**
 - When the flash is ready, the <PILOT> lamp lights.

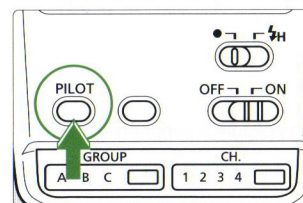

- 2 After the <PILOT> lamp lights, press it to fire a test flash.**
 - A test flash fires.
 - The <PILOT> lamp also works as a test firing button.

- Test firing is not possible while the camera's exposure metering is active after you press the shutter button halfway.
- If the SE mode is in effect, pressing the test firing button cancels the SE mode and turns on the 420EX.

Flash Exposure Confirmation

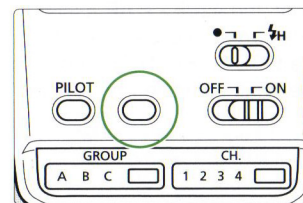

If the correct flash exposure has been obtained, the flash exposure confirmation lamp lights (in green) for about 3 sec. after the flash fires. If the flash exposure confirmation lamp does not light after the flash fires, the picture may have been underexposed. Move closer to the subject and try again.

Flash Coverage

The 420EX's flash head zooms automatically to provide adequate flash coverage for the lens focal length in use. Flash coverage is provided for the 24mm to 105mm focal lengths. The corresponding autozoom position indicator on the Speedlite lights.

When a zoom lens is used, the flash coverage changes automatically to suit the focal length you zoom to.

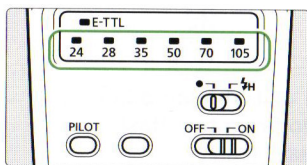

Press the shutter button halfway.

- The autozoom position indicator for the corresponding lens focal length lights.

ⓘ If a lens focal length shorter than 24mm is used, the picture's periphery will look dark.

- ⓘ • When the flash coverage changes, the Speedlite's Guide No. also changes. See the Guide No. table on page 50 to see how the Guide No. changes.
- If the lens focal length is 105mm or longer, the 105 autozoom position indicator lights.
- When the wireless selector is set to <SLAVE> (→page 42), the flash coverage is set automatically to 24mm.

AF-Assist Beam

If where you focus lacks sufficient light or contrast, the 420EX's AF-assist beam is emitted automatically so that the camera can autofocus. The AF-assist beam can cover the focusing points of the EOS 30/ELAN 7E and almost all other EOS cameras. The AF-assist beam is effective from 0.7 to 7 m/2.3 to 23ft. at the center focusing point.

AF-Assist Beam Preconditions

The preconditions for the AF-assist beam to be emitted are explained on page 51.



When the 420EX is mounted on a Type-A camera such as the EOS 30/ELAN 7E, using E-TTL autoflash is just as easy as normal autoexposure (AE). E-TTL autoflash uses the camera's multi-zone metering sensor for highly precise flash exposure control. A preflash is fired for evaluative flash metering and the reading is used to determine the main flash output. The result is a flash picture with excellent balance between the flash illumination and ambient light.

Easy Flash Photography (For Type-A Cameras)

- ⓘ • This section uses the EOS 30/ELAN 7E as the sample Type-A camera.
- Before proceeding, first turn on the main switch on the camera and 420EX.
- Set the 420EX's wireless selector to <OFF>.
- For EOS 30/ELAN 7E operations, refer to the EOS 30/ELAN 7E instruction booklet.

Flash in Full Auto Mode

With the 420EX attached to a Type-A camera set to <□> (Full Auto) or <P> (Program AE), flash photography will be fully automatic and as easy as normal AE photography without flash. The camera sets the shutter speed and aperture automatically to suit the lighting situation, whether it is dark or daylight (fill flash). E-TTL autofocus thereby sets the flash exposure automatically.

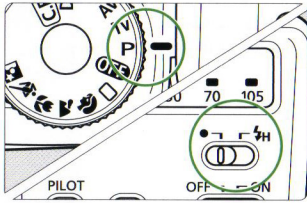

1 Set the camera to <□> (Full Auto) or <P> (Program AE).

- Fully automatic flash photography takes effect when any Basic Zone mode is set with the camera.
- Set the high-speed sync switch to <●>.



2 Focus the subject.

- The shutter speed and aperture settings are displayed in the viewfinder and on the LCD panel.
- The sync speed is set automatically anywhere from 1/60 sec. to the camera's fastest sync (varies depending on the camera). The aperture is also set automatically. (→page 52)



3 Take the picture.

- Check that the <⚡> icon is lit in the viewfinder, then take the picture.
- Immediately before the picture is taken, a preflash is fired. The main flash then follows. The subject brightness metered with the preflash is used to determine the optimum output of the main flash.

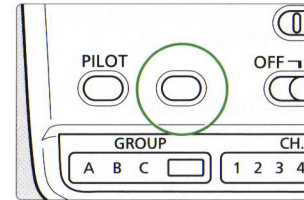

4 Check that the flash exposure confirmation lamp lights.

- When a correct flash exposure has been obtained, the lamp lights for about 3 sec. If it does not light, underexposure may have occurred. Check that the <PILOT> is lit, then move closer to the subject and take the picture again.



- The preflash is fired to obtain a meter reading of the subject.
- The main flash is used for the actual flash exposure.

Fill Flash

Even in daylight, you can use flash as fill light to soften harsh shadows or illuminate a dark, backlit subject.



- With fill flash, the subject illuminated with flash might look unnatural compared to the background's brightness. To prevent this, the flash output is reduced automatically to obtain a more natural balance between the subject and background brightness. This is called automatic flash output reduction.

Flash in Other Picture-Taking Modes

You can also use E-TTL autoflash with the camera set to <Av> (aperture-priority AE), <Tv> (shutter speed-priority AE), or <M> (manual).

Shutter Speed and Aperture Settings According to Mode

Mode	Shutter Speed	Flash Aperture
P (Program AE)	Automatically set (1/60 sec. - 1/x sec.)	Automatically set
Av (Aperture-priority AE)	Automatically set (30 sec. - 1/x sec.)	Manually set
Tv (Shutter speed-priority AE)	Manually set (30 sec. - 1/x sec.)	Automatically set
M (Manual)	Manually set (buLb, 30 sec. - 1/x sec.)	Manually set

- Manually set: Set by you.
- Automatically set: Set by the camera.
- 1/x sec.: Camera's fastest sync speed. (→page 52)
- When you press the shutter button completely, a preflash is fired immediately before the main flash is fired for the picture taken. The preflash is used to obtain subject brightness information to determine the optimum output of the main flash.
- The background exposure is set according to the shutter speed and aperture combination.
- While the 420EX's main switch is on, the E-TTL indicator lights automatically when you press the camera's shutter button halfway.

If flash is used in the <DEP> (depth-of-field AE) mode, it will be the same as using flash in the <P> (Program AE) mode.

Av : E-TTL Autoflash and Aperture-Priority AE

When you want to control the depth of field or when you want both the subject and background exposed correctly, use aperture-priority AE. You set the aperture, and the camera sets the shutter speed automatically to expose the background correctly. The E-TTL autoflash exposure is based on the aperture you set.

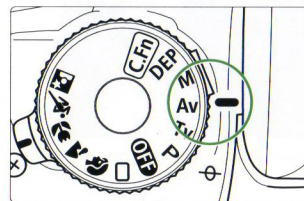

1 Set the camera's Command Dial to <Av> (aperture-priority AE).

- Set the high-speed sync switch to <●>.

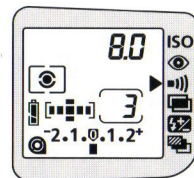

2 Set the desired aperture.

- Turn the camera's electronic dial to set the aperture.



3 Take the picture.

- Focus the subject, check that the <⚡> icon is lit in the viewfinder, then take the picture.

In low-light conditions, a slow sync speed is set automatically. A tripod is recommended for slow sync speeds.

If the camera's fastest sync speed blinks, the background will be overexposed. If the 30'' sync speed blinks, the background will be underexposed. Change the aperture setting until the sync speed stops blinking.

Slow-Speed Sync for Dark Backgrounds

By using a slow sync speed with flash, you can correctly expose both the subject and a dark background. For automatic slow-speed sync, set the camera to the <Av> mode.

When using slow-speed sync, use a tripod to prevent camera shake.



Flash with slow-speed sync.



Flash in Full Auto mode.

Under fluorescent lighting, a greenish color cast may result in the picture. And under tungsten lighting, an orange color cast may result.

- To cancel automatic slow-speed sync, set the camera to the <M> mode (→ page 24) and set the desired shutter speed and aperture.
- E-TTL autoflash will then automatically control the flash exposure.
- If you use an EOS camera mounted with an EF 135mm f/2.8 Soft Focus lens during hand-held flash photography, note the following:
 - 1) To obtain a better soft-focus effect, set the aperture manually toward the maximum opening.
 - 2) Set the shutter speed as slow as possible while preventing camera shake.
 - 3) Check that the flash is ready, then take the picture.

Tv : E-TTL Autoflash and Shutter Speed-Priority AE

When you want to use the shutter speed to create a certain effect, set the camera to shutter speed-priority AE. In this mode, you set the shutter speed anywhere from 30 sec. to the camera's fastest sync speed. The camera then sets the aperture automatically to obtain the correct background exposure. E-TTL autoflash controls the flash output based on the set aperture.

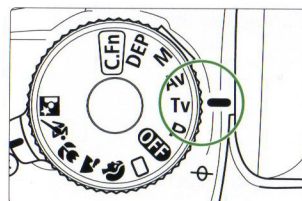

1 Set the camera's Command Dial to <Tv>.

- Set the high-speed sync switch to <●>.

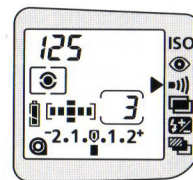

2 Set the desired shutter speed.

- Turn the camera's electronic dial to set the shutter speed.
- Set the shutter speed anywhere from 30 sec. to the camera's fastest sync speed.

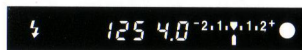

3 Take the picture.

- Focus the subject, check that the <⚡> icon is lit in the viewfinder, then take the picture.

If the minimum aperture setting blinks, the background will be overexposed. If the maximum aperture setting blinks, the background will be underexposed. Change the shutter speed until the aperture setting stops blinking.

M: E-TTL Autoflash and Manual Exposure

When you want to set both the shutter speed and aperture, use manual exposure. E-TTL autoflash controls the flash output according to the aperture you set. The background exposure is determined by the shutter speed and aperture combination.

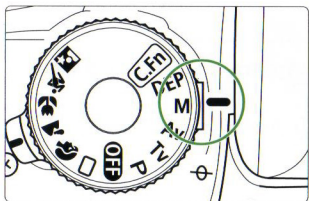
**1 Set the camera's Command Dial to <M>.**

- Set the high-speed sync switch to <●>.

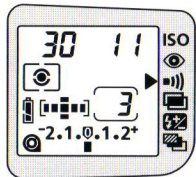
**2 Set the desired aperture and shutter speed.**

- Turn the camera's electronic dial.
- Set shutter speed anywhere from 30 sec. to the camera's fastest sync speed.

**3 Take the picture.**

- Focus the subject, check that the <⚡> icon is lit in the viewfinder, then take the picture.

High-Speed Sync (FP Flash)

When the flash mode is set to high-speed sync (FP flash), the flash can synchronize with shutter speeds faster than the camera's fastest sync speed. When high-speed sync is set, the <⚡H> icon lights in the viewfinder.

- High-speed sync can be used in the <P>, <Tv>, <Av>, and <M> modes.
- High-speed sync is effective when you want to:
 - (1) Blur the background for a daylight portrait.
 - (2) Create a catchlight in the subject's eyes.
 - (3) Soften harsh shadows on the subject's face.



With FP flash.

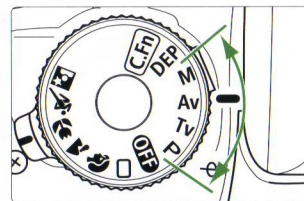
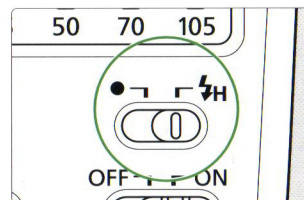

With normal flash.

**1 Set the desired picture-taking mode.****2 Set the high-speed sync switch to <⚡H>.**

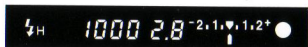

- 3 Take the picture.**
- Focus the subject, check that the <H> icon is lit in the viewfinder, then take the picture.

- Using high-speed sync changes the Guide No. See page 50.
- If you want to set the aperture, first set the camera to the <Av> or <M> mode.
- With high-speed sync, the Guide No. changes depending on the sync speed. The faster the sync speed, the shorter the effective flash range will be.
- To cancel high-speed sync, set the high-speed sync switch back to <●>.

When the <Av> mode is set for fill flash and high-speed sync is set, the sync speed will not be limited to the normal sync speed. If necessary, a faster sync speed will be set automatically in the high-speed sync mode.

FE Lock

FE (flash exposure) lock is the flash version of AE lock. With the 420EX attached to the camera, the camera's AE lock button becomes an FE lock button. With FE lock, you can lock the correct flash exposure reading for any part of the picture.

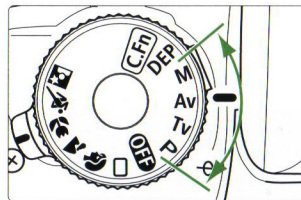

- 1 Set the camera's Command Dial to a Creative Zone mode.**

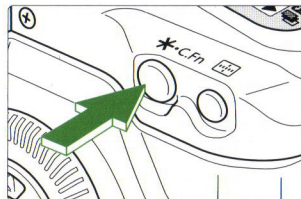

- 2 Focus the subject.**
- Press the shutter button halfway.

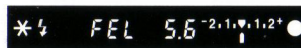

- 3 Aim the center focusing point on the subject where you want to lock the flash exposure reading, then press the <∗> button. (⊙16)**
- In the viewfinder, the <∗> icon is displayed.
 - The 420EX fires a preflash and the required flash exposure is locked.
 - In the viewfinder, <FEL> is displayed for 0.5 sec.
 - Each time you press the <∗> button, a preflash is fired to obtain the correct flash exposure which is then locked.
 - FE lock is canceled when the (⊙16) icon turns off or when the Command Dial is turned.



4 Recompose and take the picture.

- Focus the subject, check that the < lightning bolt > icon is lit in the viewfinder, then take the picture.



With FE lock.

Focusing Point for FE Lock with the EOS 30/ELAN 7E

Focusing Point Selection Method		Focusing Point for FE Lock
Automatic		Center
Manual	With C.Fn-8-0.	Center
	With C.Fn-8-1.	User-selected
Eye Control	With C.Fn-8-0.	Center
	With C.Fn-8-1.	User-selected*

* When you focus with Eye Control and press the FE lock button while pressing the shutter button halfway, FE lock is applied at the selected focusing point. Also, if you press the FE lock button without pressing the shutter button (before achieving focus), FE lock is applied at the center focusing point.

- If the subject is beyond the effective flash range (resulting in underexposure), the < lightning bolt > icon will blink. Move closer to the subject or use a larger aperture and try FE lock again.

- For FE lock, the preflash is fired at 1/32 output.
- FE lock may not be effective for a very small subject.

Second-Curtain Synchronization

The EOS 30/ELAN 7E has a Custom Function enabling 2nd-curtain synchronization.

Normally, 1st-curtain synchronization is set so that the flash is fired when the shutter curtains fully open. With 2nd-curtain synchronization, the flash is fired right before the shutter curtains close. When this is combined with a slow shutter speed, you can capture the light trail following the moving subject. This looks more natural.

- To set the camera's Custom Function, refer to the camera's Instructions.

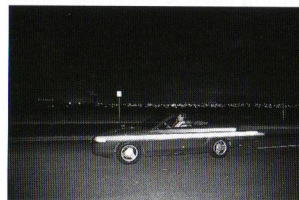

Taken with 2nd-curtain synchronization.



Taken with 1st-curtain synchronization.

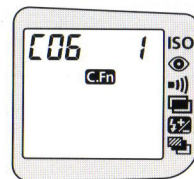

- 1 **Set the Custom Function for 2nd-curtain synchronization.**
 - With the EOS 30/ELAN 7E, set C.Fn-6-1.
- 2 **Set the picture-taking mode with the camera.**
 - < Tv > or < M > is recommended.
- 3 **Take the picture.**
 - Focus the subject, check that the < lightning bolt > icon is lit in the viewfinder, then take the picture.

- Setting < bulb > for the shutter speed makes 2nd-curtain synchronization easier.
- Second-curtain synchronization cannot be used in the < □ > (Full Auto) or in a Programmed Image Control mode.

Modeling Flash

With the 420EX attached to the EOS-1D, 1V, 3, D60, D30, ELAN 7/7E, or 30/33 you can fire a modeling flash to check the shadow effects of the flash or the lighting balance in a wireless flash system before you take the picture.

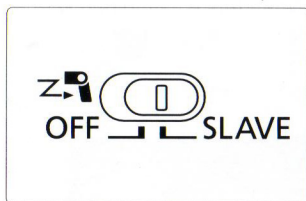

1 Set the wireless selector to <SLAVE>.

- ▶ The flash coverage is set to 24mm automatically. However, when the modeling flash is fired, the flash coverage will suit the lens focal length.

2 Check the camera and Speedlite's settings for flash photography.

3 Press the camera's depth-of-field preview button.

- The modeling flash is fired at 70 Hz for about 1 sec.

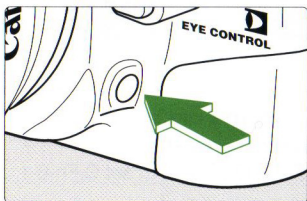

Do not fire the modeling flash more than 10 times in succession. After 10 times, allow the 420EX to cool for at least 10 minutes. This is to prevent overheating and deterioration of the flash head.

For depth-of-field preview with the camera, first set the 420EX's wireless selector to <OFF>, then press the depth-of-field preview button.



When the 420EX is mounted on a Type-B camera, using TTL autoflash is just as easy as normal autoexposure (AE). Flash photography can be fully automatic or manual where you set the shutter speed and aperture.



Easy Flash Photography (For Type-B Cameras)

- This section uses the EOS-1N as the sample Type-B camera.
- Before proceeding, first turn on the main switch on the camera and 420EX.
- Set the 420EX's wireless selector to <OFF>.
- For EOS-1N operations, refer to the EOS-1N instruction booklet.

Flash in Full Auto Mode

With the 420EX attached to a Type-B camera set to <P> (Program AE), flash photography will be fully automatic and as easy as normal AE photography without flash. The camera sets the shutter speed and aperture automatically to suit the lighting situation, whether it is dark or daylight (fill flash). TTL autoflash thereby sets the flash exposure automatically.

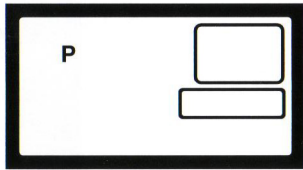

1 Set the camera to <P> (Program AE).



2 Focus the subject.

- The shutter speed and aperture settings are displayed in the viewfinder and on the LCD panel.
- The sync speed is set automatically anywhere from 1/60 sec. to the camera's fastest sync (varies depending on the camera). The aperture is also set automatically. (→page 52)

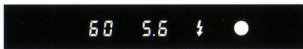

3 Take the picture.

- Check that the <⚡> icon is lit in the viewfinder, then take the picture.

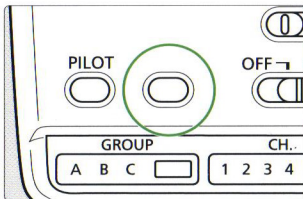

4 Check that the flash exposure confirmation lamp lights.

- When a correct flash exposure has been obtained, the lamp lights for about 3 sec.

If it does not light, underexposure may have occurred. Check that the <PILOT> is lit, then move closer to the subject and take the picture again.

Fill Flash

Even in daylight, you can use flash as fill light to soften harsh shadows or illuminate a dark, backlit subject.

With fill flash, the subject illuminated with flash might look unnatural compared to the background's brightness. To prevent this, the flash output is reduced automatically to obtain a more natural balance between the subject and background brightness. This is called automatic flash output reduction.

Flash in Other Picture-Taking Modes

You can also use TTL autoflash with the camera set to <Av> (aperture-priority AE), <Tv> (shutter speed-priority AE), or <M> (manual).

Shutter Speed and Aperture Settings According to Mode

Mode	Shutter Speed	Flash Aperture
P (Program AE)	Automatically set (1/60 sec. - 1/x sec.)	Automatically set
Av (Aperture-priority AE)	Automatically set (30 sec. - 1/x sec.)	Manually set
Tv (Shutter speed-priority AE)	Manually set (30 sec. - 1/x sec.)	Automatically set
M (Manual)	Manually set (buLb, 30 sec. - 1/x sec.)	Manually set

- Manually set: Set by you.
- Automatically set: Set by the camera.
- 1/x sec.: Camera's fastest sync speed. (→page 52)
- When you press the shutter button completely, the flash is fired and the picture is taken. The flash output is controlled by TTL autoflash (off-the-film flash metering cuts off the flash when the correct exposure is obtained) based on the aperture set.
- The background exposure is set according to the shutter speed and aperture combination.

- With Type-B cameras, the <⚡H> switch does not function.
- If flash is used in the <DEP> (depth-of-field AE) mode, it will be the same as using flash in the <P> (Program AE) mode.

Av : TTL Autoflash and Aperture-Priority AE

When you want to control the depth of field or when you want both the subject and background exposed correctly, use aperture-priority AE. You set the aperture, and the camera sets the shutter speed automatically to expose the background correctly. The TTL autoflash exposure is based on the aperture you set.

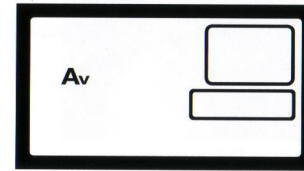

- 1 Set the camera to <Av> (aperture-priority AE).

- 2 Set the desired aperture.

- Turn the camera's electronic dial to set the aperture.

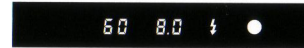

- 3 Take the picture.

- Focus the subject, check that the <⚡> icon is lit in the viewfinder, then take the picture.

- In low-light conditions, a slow sync speed is set automatically. A tripod is recommended for slow sync speeds.

- If the camera's fastest sync speed blinks, the background will be overexposed. If the 30'' sync speed blinks, the background will be underexposed. Change the aperture setting until the sync speed stops blinking.

Slow-Speed Sync for Dark Backgrounds

By using a slow sync speed with flash, you can correctly expose both the subject and a dark background. For automatic slow-speed sync, set the camera to the **<Av>** mode.

When using slow-speed sync, use a tripod to prevent camera shake.



Flash with slow-speed sync.



Flash in Full Auto mode.

- 💡 • To cancel automatic slow-speed sync, set the camera to the **<M>** mode (→ page 38) and set the desired shutter speed and aperture. TTL autoflash will then automatically control the flash exposure.
- If you use an EOS camera mounted with an EF 135mm f/2.8 Soft Focus lens during hand-held flash photography, note the following:
 - 1) To obtain a better soft-focus effect, set the aperture manually toward the maximum opening.
 - 2) Set the shutter speed as slow as possible while preventing camera shake.
 - 3) Check that the flash is ready, then take the picture.

Tv : TTL Autoflash and Shutter Speed-Priority AE

When you want to use the shutter speed to create a certain effect, set the camera to shutter speed-priority AE. In this mode, you set the shutter speed anywhere from 30 sec. to the camera's fastest sync speed. The camera then sets the aperture automatically to obtain the correct background exposure. TTL autoflash controls the flash output based on the set aperture.

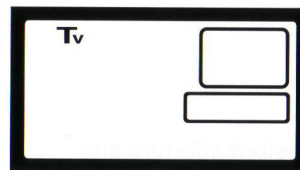

1 Set the camera to the **<Tv> mode.**

2

Set the desired shutter speed.

- Turn the camera's electronic dial to set the shutter speed.
- Set the shutter speed anywhere from 30 sec. to the camera's fastest sync speed.

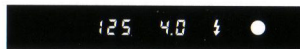

3 Take the picture.

- Focus the subject, check that the **<⚡>** icon is lit in the viewfinder, then take the picture.

- 📄 If the minimum aperture setting blinks, the background will be overexposed. If the maximum aperture setting blinks, the background will be underexposed. Change the shutter speed until the aperture setting stops blinking.

M: TTL Autoflash and Manual Exposure

When you want to set both the shutter speed and aperture, use manual exposure. TTL autoflash controls the flash output according to the aperture you set. The background exposure is determined by the shutter speed and aperture combination.

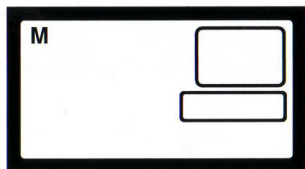

1 Set the camera's Command Dial to <M>.

2 Set the desired aperture and shutter speed.

- Turn the camera's electronic dial.
- Set shutter speed anywhere from 30 sec. to the camera's fastest sync speed.



3 Take the picture.

- Focus the subject, check that the <⚡> icon is lit in the viewfinder, then take the picture.

Bounce flash, flash exposure compensation, and a multi-Speedlite system are possible with the 420EX and a Type-A or B camera.

Advanced Flash Photography (For Type-A and B Cameras)

Bounce Flash

When the flash is aimed directly at the subject, a harsh shadow may appear behind the subject. By bouncing the flash off the ceiling or wall, you can reduce or eliminate the shadow for a more natural-looking picture.



Taken with bounce flash.



Taken with direct flash.

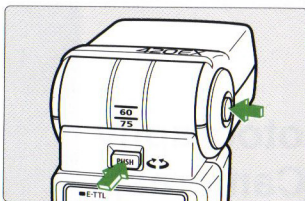

1 Turn the flash head toward the bounce surface.

- While pressing the <PUSH> or <PUSH> button, turn the flash head toward the ceiling or wall where the flash can bounce off.
- The flash head can be turned upward and/or sideways.
- With bounce flash, the flash coverage is set automatically to 50mm, and the 50mm autozoom position blinks.

The flash head can be turned at the angles listed below with respect to the normal flash head position.

Direction	Maximum Angle	Click Stops
Up	90°	0° 60° 75° 90°
Left	180°	0° 60° 75° 90°
		120° 150° 180°
Right	90°	0° 60° 75° 90°

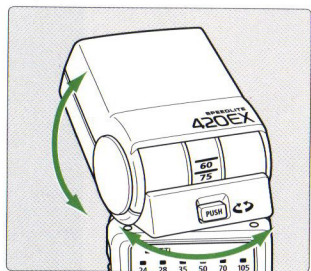

2 Take the picture.

- Focus the subject, check that the <L> icon is lit in the viewfinder, then take the picture.
 - If the flash exposure confirmation lamp does not light after the picture is taken, use a larger aperture and try again.
- If the ceiling or wall is too far away, the flash reaching the subject may be insufficient, resulting in underexposure.
 - The bounce surface should be a solid, white color that can reflect light. If the bounce surface is not a solid, white color, the picture might have a color cast based on the bounce surface's color or pattern.

Flash Exposure Compensation

If you have an EOS camera that can set flash exposure compensation, you can apply flash exposure compensation to the 420EX. To set flash exposure compensation, refer to the camera's instruction booklet.

- Flash exposure compensation can be set with the EOS-1D, 1V, 1N, 1N RS, 3, D60, D30, ELAN 7/7E, 30/33, 5, A2, A2E, ELAN II/ELAN II E, 50/50 E, and IX.

Multi-Speedlite System

By using multiple Speedlites, you can create more sophisticated lighting effects. The subject's face can look more three-dimensional or an accent light can be created. The flash exposure is fully automatic even with multiple Speedlites, making it very easy.

The multi-Speedlite system can be wireless or wired. In a wireless flash system, a Type-A camera is attached with a master unit (550EX, ST-E2, MR-14EX or MT-24EX) and the 420EX is set as a slave unit. In a wired flash system, multiple EOS-dedicated Speedlites (including the 420EX) are connected by wired flash system accessories.

Wireless Flash System

The 420EX has a wireless slave setting that enables it to be a wireless slave unit. It can thereby be used in an E-TTL wireless autoflash system together with a Type-A (E-TTL-compatible) camera and a master unit (550EX, ST-E2, MR-14EX or MT-24EX).

The flash exposure is controlled by the master unit which makes it easy to use a wireless flash system for sophisticated lighting effects. Using multiple Speedlites is as easy as using just one Speedlite mounted on the camera.

For details on wireless flash photography or on master unit operations, refer to the master unit's instruction booklet.

- 1 Set the master unit.**
 - Attach the 550EX, ST-E2, MR-14EX or MT-24EX to the camera and set it as the master unit.
- 2 Set the 420EX as a slave unit.**
 - Set the wireless selector to <SLAVE>.
 - The flash coverage is set to 24mm automatically.
 - When the flash is ready, the AF-assist beam emitter blinks once per second continuously.

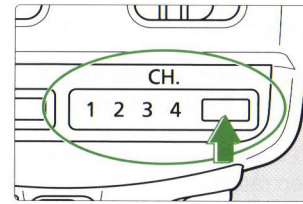
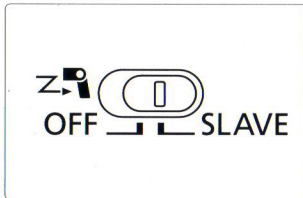

3 Set the channel No.

- Press the <CH.> button and set the same channel No. as the master unit's.
- Pressing the <CH.> button selects the channel No. in the following looping sequence: 1, 2, 3, 4...

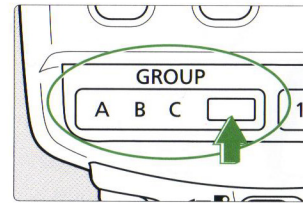

4 Set the slave group ID.

- Set the slave group ID if you are using the EOS-1D, 1V, 3, D60, D30, ELAN 7/7E, or 30/33 with two (A and B) or three slave groups (A, B, and C). If you are using a Type-A camera other than the above, you need not set the slave group ID since only one slave group can be used.
- Press the <GROUP> button to set the slave group ID.
- Pressing the <GROUP> sets the slave group ID in the following looping sequence: A, B, C...

5 Position the Speedlites and fire a test flash.

- Use the mini-stand (provided) to position the slave unit(s) within the effective wireless transmission range.
- Press the test firing button on the master unit to see if the slave unit(s) fire.

6 Take the picture.

- If the master unit's flash mode is set to <M> (manual flash) or <MULTI> (stroboscopic flash), the slave unit(s) will not fire. Be sure to set the master unit's flash mode to <E-TTL>.
- With a Type-B camera, wireless flash photography is not possible with the 420EX.

Sample Wireless Flash System

You can easily set up an E-TTL wireless autoflash system with the 550EX, ST-E2, MR-14EX or MT-24EX as the master unit and the 420EX as the slave unit.

Just set the 420EX's wireless selector to <SLAVE> and position the slave unit(s) as desired within the wireless transmission range.

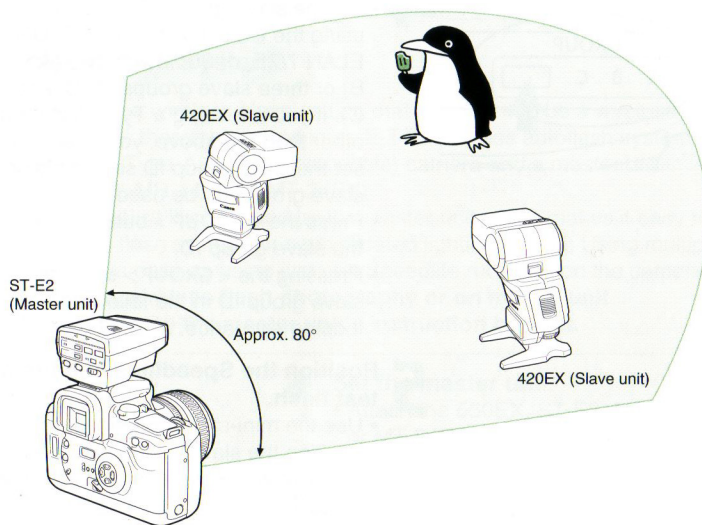

- The 420EX and 550EX can be set and used together as wireless slave units.
- If the 420EX slave unit is not used for about 10 minutes, the SE mode (→page 14) will take effect (indicated by a blinking channel No.) automatically to turn off the power.
Pressing the master unit's test firing button within 30 minutes after the SE mode starts will turn the slave unit back on.

Wireless Flash Equipment

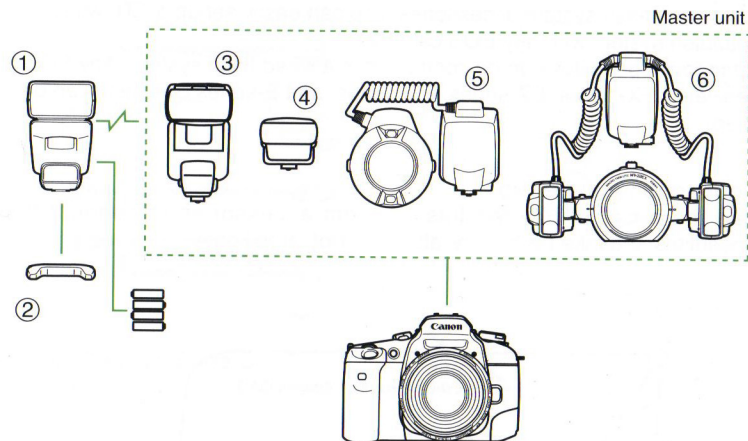

- ① **Speedlite 420EX (Slave unit)**
- ② **Mini-stand (Provided with 420EX)**
Props up the 420EX and provides a tripod socket.
- ③ **Speedlite 550EX**
Serves as a normal Speedlite or as the master unit or slave unit in a wireless flash system.
- ④ **Speedlite Transmitter ST-E2**
Dedicated wireless transmitter serving as the master unit controlling slave unit(s) in a wireless flash system.
- ⑤ **Macro Ring Lite MR-14EX** / ⑥ **Macro Twin Lite MT-24EX**
Designed for macro flash photography, this can also serve as the master unit in a wireless flash system.

Wired Flash System

With wired flash system accessories, you can easily set up a TTL wired autoflash system with any EOS camera.

Up to four Speedlites can be connected in a wired flash system. Any EOS-dedicated EX-series, EZ-series, EG-series, and E-series Speedlite can be used.

Connection and Set-up

Use the necessary wired flash system accessories to connect the Speedlites and take the picture after the pilot lamp lights.

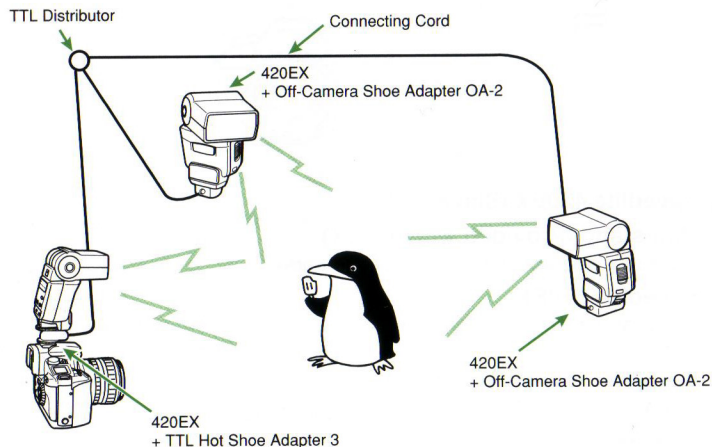

- If the TTL Hot Shoe Adapter 3's internal battery power is very low, the Speedlite's flash-ready indicator will not light and no flash will be fired. Check the TTL Hot Shoe Adapter 3's battery level before using it.
- Do not extend the Connecting Cord length by more than 9 meters (three 300cm cords connected together).

Wired Flash System Accessories

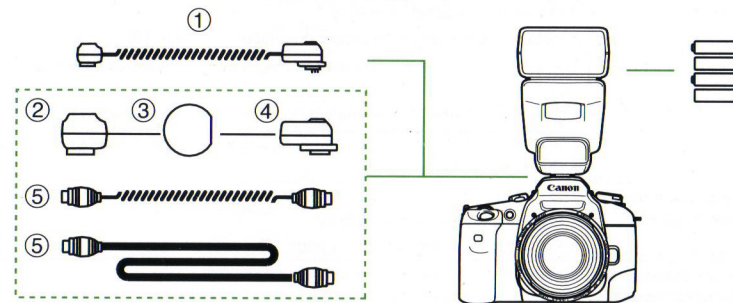

① Off-Camera Shoe Cord 2

Enables the Speedlite to be used off-the-camera up to 60 cm away. All of the Speedlite's functions can still be used.

Multi-Speedlite Accessories

② Off-Camera Shoe Adapter OA-2

Enables the Speedlite to be positioned off-the-camera. This adapter is connected to the TTL Hot Shoe Adapter 3 or TTL Distributor via a Connecting Cord.

③ TTL Distributor

Equipped with four Connecting Cord sockets, the TTL Distributor relays the information from the TTL Hot Shoe Adapter 3 to the multiple Speedlites connected via Off-Camera Shoe Adapter OA-2.

④ TTL Hot Shoe Adapter 3

Equipped with a hot shoe and a Connecting Cord socket, this Adapter is attached to the camera's hot shoe. A Speedlite is then mounted on the Adapter's hot shoe and a Connecting Cord is connected to the socket. By connecting the other end of the Connecting Cord to an Off-Camera Shoe Adapter or a TTL Distributor, you can connect multiple Speedlites to one camera.

⑤ Connecting Cord 60 and Connecting Cord 300

Available in two lengths (60 cm and 300 cm), the Connecting Cords are used in a wired, multi-Speedlite system.

Troubleshooting Guide

The flash does not fire.	The batteries are exhausted. ▶ Install new batteries. (→ page 10)
	Batteries are installed incorrectly. ▶ Install the batteries in the proper orientation. (→ page 10)
	The 420EX's mounting foot is not securely mounted on the camera's hot shoe. ▶ Slide the mounting foot all the way into the hot shoe. (→ page 12)
	The camera's hot shoe contacts or the 420EX's contacts are dirty. ▶ Clean the contacts.
The power turns off automatically.	The 420EX has not been used for 90 sec. ▶ Press the shutter button halfway. ▶ Press the test firing button. (→ page 15)
The 420EX cannot be detached from the camera.	The locking collar has not been loosened enough. ▶ Loosen the locking collar until the locking pin disengages. (→ page 12)
The subject looks blurred in the picture.	If flash is used in the <Av> mode under low-light conditions, a slow sync speed is set automatically. A blurred picture is prone to occur if the camera is handheld at a slow sync speed. ▶ Use a tripod. (→ page 22, 36) ▶ Set the camera to the <P> mode. (→ page 18, 32)
With high-speed sync, the picture came out underexposed.	With high-speed sync, the Guide No. changes depending on the sync speed. The faster the sync speed, the shorter the effective flash range will become. ▶ Check the Guide No. before taking the picture. (→ page 50)
The slave unit does not fire.	The slave unit's wireless selector is set to <OFF>. ▶ Set the wireless selector to <SLAVE>. (→ page 13)
	The slave unit is not within the master unit's wireless transmission range. ▶ Position the slave unit within the master unit's wireless transmission range.
	The slave unit's wireless sensor does not face the master unit. ▶ Point the slave unit's wireless sensor toward the master unit. (→ page 44)
	The master unit's flash mode is set to <M> or <MULTI>. ▶ Set the master unit's flash mode to <E-TTL>. (→ page 43)

Major Specifications

Type	Direct-contact, shoe-mount flash with E-TTL/TTL autoflash. (AF-assist beam, autozoom head, bounce flash, and wireless slave setting provided.)
Compatible cameras	Type-A EOS cameras (E-TTL autoflash). (→ page 2) Type-B cameras (TTL autoflash). (→ page 2)
Flash coverage and Guide No.	See page 50.
Recycling time and flash count ...	See page 11 and 50.
Flash duration	1.2 ms or less with normal flash.
Flash coverage.....	Autozoom head is positioned automatically to suit the lens focal length (24mm, 28mm, 35mm, 50mm, 70mm, and 105mm).
Flash modes.....	(1) Normal sync (2) High-speed sync (FP flash) (3) Test firing (4) Modeling flash (at 70 Hz for 1 sec.)
Bounce angles	See page 40.
Exposure control modes:	(1) E-TTL autoflash (with Type-A cameras and preflash evaluative metering) (2) FE lock (with Type-A cameras and preflash evaluative metering) (3) TTL autoflash (with Type-B cameras and off-the-film flash metering)
Flash exposure compensation....	(1) Automatic flash output reduction for fill flash. (2) Enabled with cameras having a flash exposure compensation feature.
Flash range	(1) With normal sync: 0.7 - 24.2 meters (with 50mm f/1.4 lens at ISO 100) (2) With high-speed sync: 0.7 - 12.7 meters (at 1/180 sec.)
Sync speed	See page 52.
Flash-ready indication	Red pilot lamp.
Flash exposure confirmation ..	Yellow-green lamp.
AF-assist beam range	Covers 1, 3, 5, or 7 focusing points (covers only a part of the 45-point Area AF). Range at center Approx. 0.7 - 7 m, Range at periphery Approx. 0.7 - 5 m (in total darkness).
Wireless slave setting	Slave setting Wireless selector set to SLAVE. Channels 4 Slave group ID A, B, C Reception angle Approx. +/-40° horizontal, +/-30° vertical Flash coverage Set to 24mm automatically. Flash-ready indicator AF-assist beam emitter blinks. Exposure control Automatic with the master unit (for E-TTL autoflash). Test flash Enabled with master unit's test firing button.
SE mode	Power turns off automatically after 90 sec. of non-use. Power turns on with test firing button.
Power source:	(1) Four size-AA alkaline batteries (2) Four size-AA nickel-hydride batteries * Four size-AA lithium batteries
Dimensions (mm)	71.5 (W) x 123 (H) x 99.4 (D) mm 2.8 (W) x 4.82 (H) x 3.89 (D) in
Weight.....	300 g / 10.6 oz (excluding batteries)

- The above specifications are based on Canon's testing standards.
- Specifications and the external appearance are subject to change without notice.

Guide No.

[Normal Sync]

(At ISO 100 in meters)

Flash Coverage (mm)	24	28	35	50	70	105
Guide No.	23	25	31	34	37	42

[High-speed Sync (FP Flash)]

(At ISO 100 in meters)

Sync Speed	Flash Coverage					
	24	28	35	50	70	105
1/180	12.1	13.1	16.3	17.9	19.5	22.1
1/250	11.0	12.0	14.9	16.3	17.7	20.1
1/350	9.7	10.5	13.0	14.3	15.6	17.7
1/500	8.1	8.8	11.0	12.0	13.1	14.8
1/750	6.8	7.4	9.2	10.1	11.0	12.5
1/1000	5.8	6.3	7.8	8.5	9.3	10.5
1/1500	4.8	5.3	6.5	7.1	7.8	8.8
1/2000	4.1	4.4	5.5	6.0	6.5	7.4
1/3000	3.4	3.7	4.6	5.1	5.5	6.2
1/4000	2.9	3.1	3.9	4.3	4.6	5.3

- The Guide No. above apply to full flash output.

Recycling Time and Flash Count

Battery Type	Recycling Time (sec.)	Flash Count
Size-AA alkaline batteries	Approx. 0.1 - 7.5	Approx. 200-1400

- The above specifications are based on Canon's testing standards.
- Using size-AA nickel-hydrate batteries will yield only about 70 to 80 percent of the flashes (1550 mAh at full output) obtainable with size-AA alkaline batteries. The recycling time will also be about half the time with size-AA alkaline batteries.

Camera's Flash Exposure Warnings

Mode	Warning Indication	Description	Remarks
Program AE	Minimum aperture setting blinks.	The subject is too bright.	Attach a neutral-density (ND) filter to the lens to reduce the amount of light received by the camera.
Aperture-priority AE	Fastest sync speed blinks.	The background will be overexposed.	Only the flash exposure setting for the subject is correct. Setting a smaller aperture could stop the shutter speed from blinking.
Shutter speed-priority AE	Minimum aperture setting blinks.	The background will be overexposed.	Only the flash exposure setting for the subject is correct.
	Maximum aperture setting blinks.	The background will be underexposed.	

Preconditions for AF-Assist Beam Emission

420EX & EOS Camera Combination	AF-assist by 420EX	AF-assist by the Camera
EOS D60, EOS-1D, EOS 3000N/66/REBEL XSN, EOS D30, EOS ELAN 7/7E, 30/33, EOS-1V, EOS 300/REBEL 2000, EOS-3, EOS IX 7/IX Lite, EOS IX, EOS REBEL G/500N, EOS ELAN II/ELAN II E/50/50 E, EOS-1N, EOS-1N RS, EOS REBEL II/REBEL S II/1000 N/1000 FN, EOS ELAN/100, EOS REBEL/REBEL S/1000/1000 F, EOS 700, EOS RT, EOS-1, EOS 630/600, EOS 850, EOS 750, EOS 620, EOS 650	○	—
EOS 3000/88, EOS 5000/888, EOS REBEL X/REBEL XS/500, EOS 5/A2/A2E, EOS 10/10S	—	○

- If the EOS camera has multiple focusing points and focus cannot be achieved with the 420EX's AF-assist beam or if the 420EX's AF-assist beam is not emitted, focus with the center focusing point.

EOS Camera and 420EX Feature Availability

●: Available.
x: Not available.

Camera	Camera's Max. Sync Speed (sec.)					Flash Metering		FP Flash	FE Lock	Flash Exposure Compensation w/Camera	2nd-Curtain Sync	Modeling Flash	Slave Setting (E-TTL)
	1/90	1/125	1/200	1/250	1/500	E-TTL	TTL						
EOS 650		●				x	●	x	x	x	x	x	x
EOS 620				●		x	●	x	x	x	x	x	x
EOS 750		●				x	●	x	x	x	x	x	x
EOS 850		●				x	●	x	x	x	x	x	x
EOS 630/600		●				x	●	x	x	x	x	x	x
EOS-1				●		x	●	x	x	x	x	x	x
EOS RT		●				x	●	x	x	x	x	x	x
EOS 10/10S		●				x	●	x	x	x	x	x	x
EOS 700		●				x	●	x	x	x	x	x	x
EOS REBEL/REBEL S/1000/1000 F	●					x	●	x	x	x	x	x	x
EOS ELAN/100		●				x	●	x	x	x	x	x	x
EOS 1000REBEL II/REBEL S II/1000 N/1000 FN	●					x	●	x	x	x	x	x	x
EOS 5/A2/A2E			●			x	●	x	●	x	x	x	x
EOS REBEL X/REBEL XS/500	●					x	●	x	x	x	x	x	x
EOS-1N/1N RS				●		x	●	x	●	x	x	x	x
EOS 5000/888	●					x	●	x	x	x	x	x	x
EOS ELAN II/ELAN II E/50/50 E		●				●	x	●	●	●	●*	x	●
EOS REBEL G/500N	●					●	x	●	●	x	x	x	●
EOS IX			●			●	x	●	●	●	x	x	●
EOS IX 7/IX Lite		●				●	x	●	●	x	x	x	●
EOS-3			●			●	x	●	●	●	●*	●	●
EOS 3000/88	●					x	●	x	x	x	x	x	x
EOS 300/REBEL 2000	●					●	x	●	●	x	x	x	●
EOS-1V				●		●	x	●	●	●	●*	●	●
EOS ELAN 7/7E/30/33		●				●	x	●	●	●	●*	●	●
EOS D30/D60			●			●	x	●	●	●	●*	●	●
EOS 3000N/66/REBEL XSN	●					●	x	●	●	x	x	x	●
EOS-1D					●	●	x	●	●	●	●*	●	●

* Enabled with the camera's Custom Function.

This device complies with Part 15 of the FCC Rules. Operation is subject to the following two conditions: (1) This device may not cause harmful interference, and (2) this device must accept any interference received, including interference that may cause undesired operation.

Do not make any changes or modifications to the equipment unless otherwise specified in the instructions. If such changes or modifications should be made, you could be required to stop operation of the equipment.

This equipment has been tested and found to comply with the limits for a class B digital device, pursuant to part 15 of the FCC Rules. These limits are designed to provide reasonable protection against harmful interference in a residential installation. This equipment generates, uses and can radiate radio frequency energy and, if not installed and used in accordance with the instructions, may cause harmful interference to radio communications.

However, there is no guarantee that interference will not occur in a particular installation. If this equipment does cause harmful interference to radio or television reception, which can be determined by turning the equipment off and on, the user is encouraged to try to correct the interference by one or more of the following measures:

- Reorient or relocate the receiving antenna.
- Increase the separation between the equipment and receiver.
- Consult the dealer or an experienced radio/TV technician for help.

This digital apparatus does not exceed the Class B limits for radio noise emissions from digital apparatus as set out in the interference-causing equipment standard entitled "Digital Apparatus", ICES-003 of the Industry Canada.



The CE Mark is a Directive conformity mark of the European Community (EC)

The apparatus shall not be exposed to dripping or splashing.
Batteries shall not be exposed to excessive heat such as sunshine, fire or the like.
Dry batteries shall not be subjected to charging.