

WILSONWERKS ARCHIVES

This camera manual is for reference and historical purposes, all rights reserved.

This cover page is copyrighted material. This document may not be sold or distributed without the express consent of the publisher.

©2008 wilsonwerks Llc

EXAKTA

VX II α

35 mm

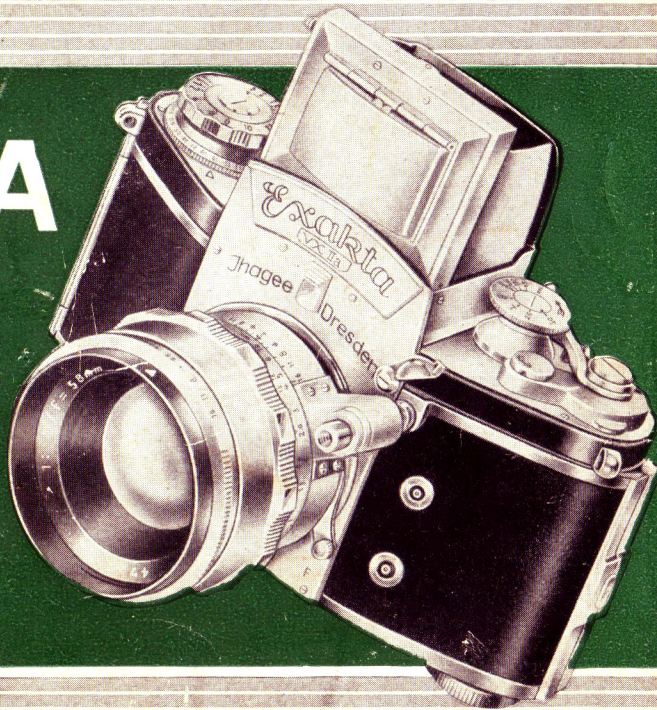
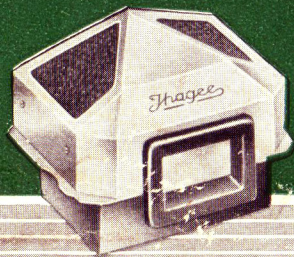

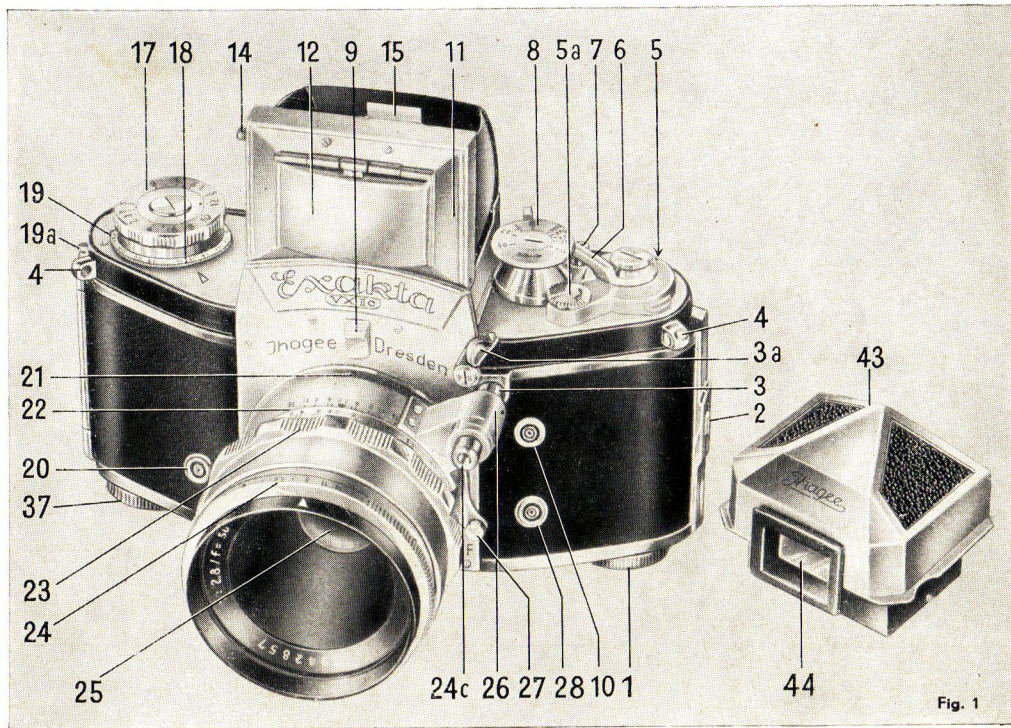

Fig. 1

- 18 = film speed indicator
- 19 = film transport control disc
- 19a = removable axle of camera back hinge
- 20 = "M" flashbulb contact
- 21 = matching mark for changing lenses
- 22 = depth of field scale
- 23 = distance setting ring
- 24 = aperture setting ring
- 24b = lever for setting automatic diaphragm
- 24c = release knob for automatic diaphragm
- 25 = objective
- 26 = matching mark on lens as per No. 21
- 27 = lens bayonet catch
- 28 = "F" flashbulb contact
- 29 = take-up spool for exposed film
- 30 = chamber for take-up spool or film cartridge
- 31 = film transport sprockets
- 31a = cartridge holder
- 32 = film guides
- 33 = film gate
- 34 = knife for cutting exposed film
- 35 = handle of knife
- 36 = fork of film rewinding knob
- 37 = film rewinding knob
- 38 = central shaft of rewinding knob (push in before rewinding!)
- 39 = chamber for cartridge with unexposed film
- 40 = hinged and removable back cover
- 41 = film pressure plate
- 42 = camera retaining screw
- 43 = Penta Prism
- 44 = ocular of Penta Prism

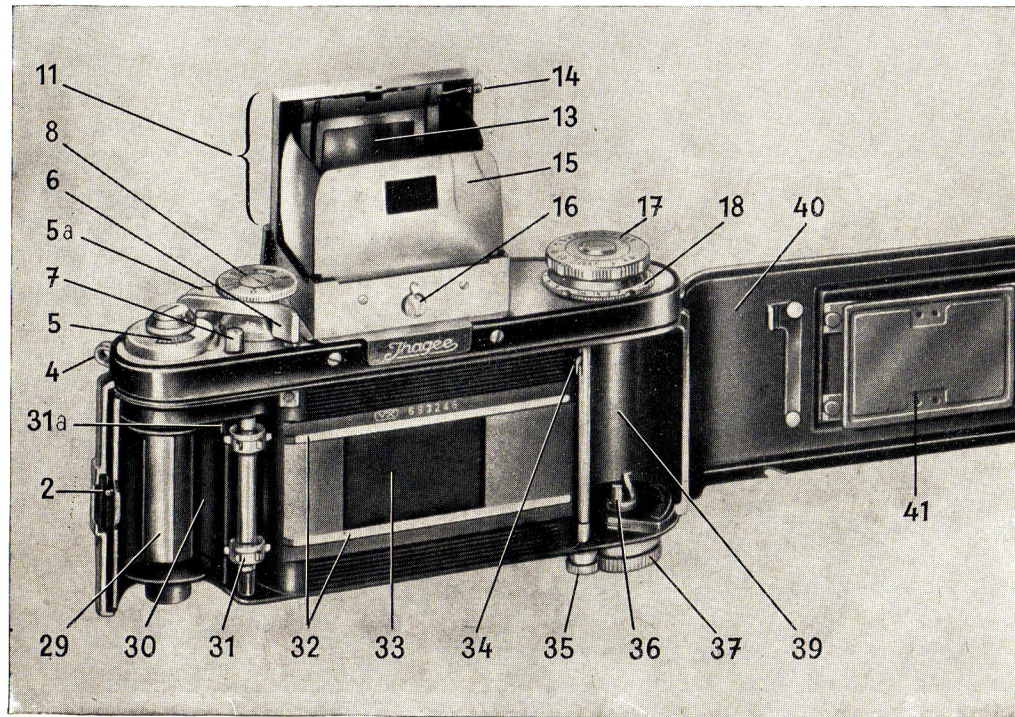

Fig. 2

44 important camera parts

- 1 = button for opening camera-back (also see Fig. 4)
- 2 = camera back lock (operated by button No. 1)
- 3 = shutter release knob
- 3a = swivelling shutter release lock
- 4 = neck-strap eyelets
- 5 = exposure counter
- 5a = knob for setting exposure counter
- 6 = film transport and shutter winding lever
- 7 = rewinding stud
- 8 = fast speed setting knob for $1/25$ to $1/1000$ sec., "T", and "B"
- 9 = finder-hood and Penta Prism release
- 10 = "X" electronic flash contact
- 11 = reflex finder-hood
- 12 = cover of hinged focusing magnifier
- 13 = focusing magnifier (folded down)
- 14 = handle of No. 13
- 15 = back wall of finder-hood with rear frame of sport finder
- 16 = finder-hood catch
- 17 = slow speed ($1/5$ -12 sec.) and delayed action ($1/5$ -6 sec. with delayed time) setting knob

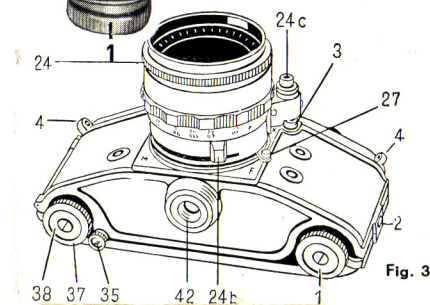

Fig. 3

How to use
the

EXAKTA



35mm

Contents

	Page
A. To open and shut the back cover	5
B. To open and shut the finder-hood	6
C. Shutter and film transport.....	7
D. The lens of the EXAKTA and instructions for focusing	12
E. How to use and exchange the finder-hood	18
F. How to use and exchange the Penta Prism and the Exposure Meter Insert	22
G. To load the EXAKTA VX	25
H. To change films	29
J. Flash technique	33
K. EXAKTA accessories	38
L. Careful handling of camera and lens.....	58

Some details in the illustrations may slightly deviate from the execution of the cameras and accessories themselves.

The 35 mm EXAKTA VX IIa (24x36 mm) is the latest in development of our well-known Kine-Exakta, **first** 35 mm single-lens reflex camera.

This camera offered ground glass focusing with 35 mm miniature photography so highly esteemed by beginners and experts, using one lens only for the reflex image and the picture. The EXAKTA VX IIa is built on the same basic principle of the **single** lens reflex:

It has internally a small movable mirror which reflects the picture by the taking lens on the reflex focusing-screen until pressing the shutter release knob. In this manner only can the reflex image always fully correspond with the final photograph (the EXAKTA VX is parallax free) so that you may rely with confidence on the ground glass image when choosing the subject and focusing critically. Though the first Kine-Exakta was a very versatile camera, it is, in this respect, much surpassed by the Multi-System Camera EXAKTA VX: The 5 interchangeable focusing systems permit to utilise all the advantages of the single-lens reflex camera and of the camera with eye level rangefinder guaranteeing full success through adaptability to every photographic work.

The EXAKTA VX is a high precision camera and meets all requirements, if it is correctly operated from the beginning. **Before trying picture taking, please study carefully the instructions how to use your new camera!** You will render yourself the best service, when doing so, avoiding later mistakes and any possible damage of the camera mechanism.

We are glad that you have selected the EXAKTA VX for your work and we wish you all success with this new camera. Please, stay always in contact with your photodealer, that he may keep you informed about the progress in our manufacture. We ourselves are also at your disposal whenever you need help or advice in special problems as to the EXAKTA VX.

IHAGEE KAMERAWERK AKTIENGESELLSCHAFT · DRESDEN GERMANY

Fig. 4

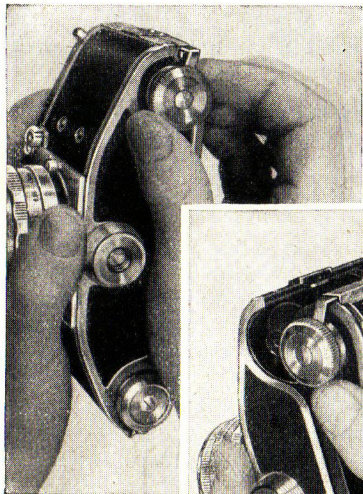

Before loading the EXAKTA VX,

be thoroughly acquainted with the empty camera. Train yourself to master the shutter, opening and closing the camera, composing and critically focusing the picture with the finder-hood as well as with the Penta Prism. When doing so, handle the camera as if it were loaded. Only after having attained a complete mastering of the camera, load it with film. For practising we advice to use an old or an exposed film.

Fig. 5

A. To open and shut the back cover

Hold the camera (Fig. 4) with your left hand. With the right hand pull out the button (1) and lock it in this position by short turn to the side. Pull away the hinged back cover (40) from the camera body with your right index on the camera back lock (2) (Fig. 5). The back cover (40) is attached to the body by a hinge. When loading the EXAKTA VX don't shift the opened cover towards your body, because, when doing so, the hinge may be damaged. When closing the back cover (40) take care that it engages correctly the groove in the camera body. Press the cover (40) slightly against the camera body. Turn the button (1) to the left or right, until it snaps into position. Thus the back cover is locked again safely.

If desired the back cover can be separated from the camera; open the cover, pull out the removable pin (19a, Fig. 1, see also Fig. 6). In this respect, too, the EXAKTA VX meets all individual requirements. When the back separated from the camera is put on again and closed, take care that the grooves of the back and the body are fitting. Insert the pin into the hinge, as figure 6 shows, and you have the back hinged again.

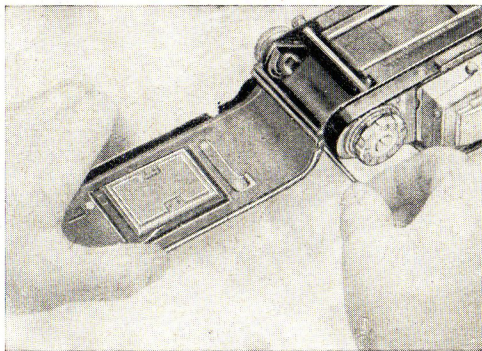

Fig. 6

B. To open and shut the finder-hood

Press knob (16) and the finder-hood (11) opens automatically (Fig. 7). For a detailed description of its use and the various possibilities for observing the image see chapter E (page 18). We mention here its most important features only: The ground glass image is strictly identical with the future photograph. Therefore the ground glass image is the decisive factor in successful picture taking: composition, framing, critical focusing, lens aperture, even the degree of brightness of the ground glass image permits to determine the exposure time fairly accurately. — If there is no image visible in the finder-hood, the filmtransport lever (6) is to be wound once, clockwise, as far as it will go (Fig. 8). Don't let recoil the lever, but retard the retrograde movement with your left thumb.

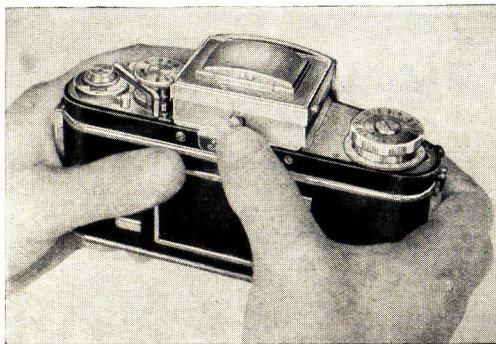

Fig. 7

Attention! Film transporting and shutter winding are in order, if the film transport lever (6) automatically springs back into neutral position. If stuck halfway, it must never be forced back, otherwise the mechanism will be damaged. Besides, it is impossible to release the shutter, even if the release knob (3) has been unlocked, at any inbetween position of the film transport lever (6), see page 8. This is a security against partial double exposures resulting from incomplete film transporting. It does not matter if the shutter remains wound up for a longer period.

Fig. 8

When camera unloaded, it may happen that the film transport lever (6) does not return from the end stop to the neutral position. Then open the back of the camera and turn the film transport sprockets (31) a little in the direction of the film-cassette (30). At the same time elastically press the film transport lever which now returns to its neutral position.

Before closing the finder-hood (11) make sure that the critical focusing magnifier (13) is in its neutral position (Section E). Fold the two side-walls of the finder-hood (in either order), then the back wall (15), and finally the front cover until it snaps into position (Fig. 9).

C. Shutter and film transport

The EXAKTA VX has a high precision focal-plane shutter. In order to study its working, observe the camera opened from behind. When removing the lens (see Section D, page 12), you will, on releasing, see the mirror swinging-up under the finder-hood, that no stray light may get into the

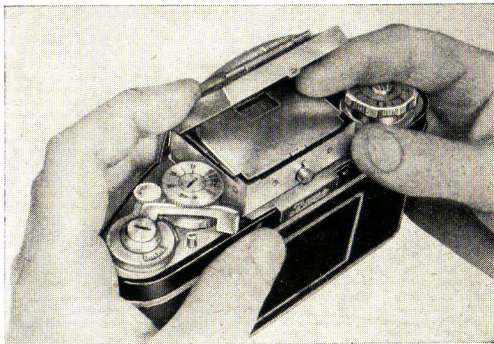
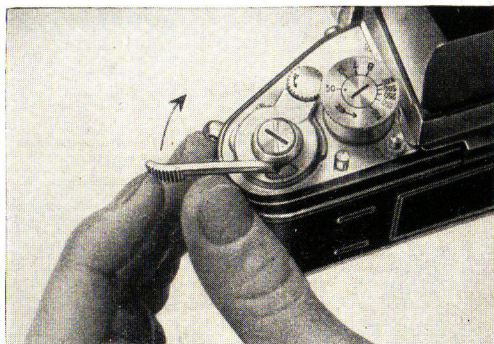

Fig. 9

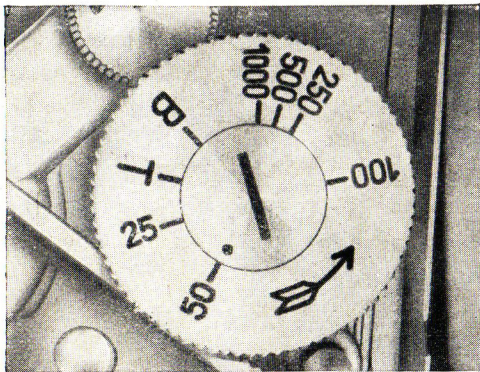

Fig. 10

interior of the camera. The ground glass image, therefore, is not visible, unless after picture taking the shutter has been wound again.

The focal-plane shutter of the EXAKTA VX is remarkable by its great variety of exposures. With the fast speed knob (8) (Fig. 10) the exposures of $1/1000$ up to $1/25$ sec. are set. The figures engraved are fractions of seconds: $25 = 1/25$, $50 = 1/50$ sec. etc.

To set, lift the knob (8) and turn it in the direction of the arrow till the selected exposure time is opposite the red mark on the immovable interior disk. Then let the knob (8) snap down. In the same way set the shutter for B and T. To release (Fig. 11) press knob (3), which also has threads for a cable release. The release knob may be protected against unintentional tripping by the swivelling shutter release lock (3a) (important for transporting as well as for storing the camera). To free the release knob for exposing the lock has to be swung up. If knob (8) is set on B, the shutter opens upon pressure on the release knob

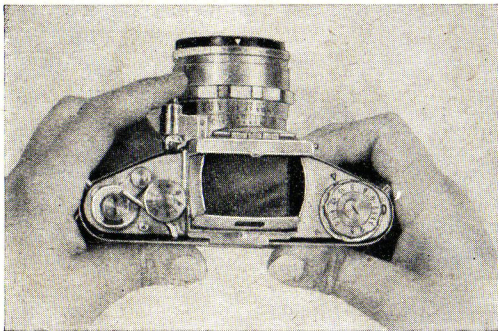

Fig. 11

(3), remains open as long as the knob is pressed, and closes as soon as the pressure ceases. When knob (8) is set on T, the shutter opens after pressure on the release knob (3) and remains open till the release knob (3) is pressed again. These two settings (B and T) are used for long time exposures over 12 seconds, because the time setting work of the EXAKTA VX allows for exposure times up to 12 seconds (see below!). Longer exposure times than 12 sec. are controlled by counting the seconds or with a watch. In this case you must definitely use a tripod (camera retaining screw (42) on camera base) or place the camera on a stable support (table, wall, etc.). whereas fast exposures of $1/25$ down to $1/1000$ sec. are possible as "hand-held" shots. With the slow speed knob (17) it is possible to set exposure times longer than $1/25$ sec. (17) (Fig. 12). The fractions of seconds (e. g. $1/5$ sec.) are indicated on the slow speed knob (17) as fractional numbers, while all the whole numbers mean full seconds (e. g. 1=1 sec., 2=2 sec. etc.). The black figures are for exposures immediately after releasing. The red marks, however, indicate that the shutter opens about 13 seconds after releasing, the self-timer permitting yourself to step into the picture. In other words, the photographer operating the camera can take a picture of himself. The time regulation mechanism and the self-timer of the EXAKTA VX Ila function practically free from noise and must be operated strictly as follows:

- a) Set the fast speed knob (8) on T or B.
- b) Before handling the slow speed knob (17) cock the shutter by swinging around the film transport lever (6) as far

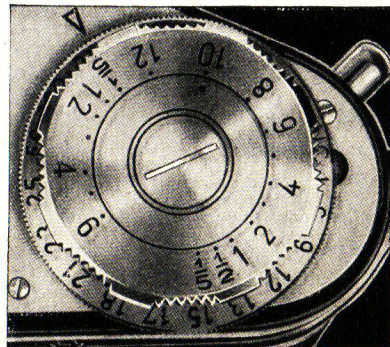

Fig. 12

as it will go. Then firmly turn the slow speed knob (17) clockwise as far as it will go, in this way winding the time regulation mechanism. If you have used a shorter exposure time before, the mechanism has run down a little only. You must not be irritated by this fact; but in any case the resistance is to overcome, which is caused from an additional spring and the last bit must be rewound vigorously as far as it will go.

- c) Only after winding, lift the outer ring of the slow speed knob (17), turn the ring until the speed selected is opposite the red mark of the middle ring, and let snap the outer ring of the knob (17) into position.
- d) Black figures = immediate exposure,
red figures = exposure with 13 seconds delay (self-timer).

If you wish to use one of the fast speeds of $\frac{1}{25}$ down to $\frac{1}{1000}$ sec. by means of the self-timer (= delayed action release) do as follows (shutter must be cocked):

- a) Set fast speed knob (8) on the speed selected (e. g. $\frac{1}{25}$ sec.).
- b) Wind slow speed knob (17) as far as it will go and set it on any red figure — preferably on $\frac{1}{5}$ sec.

After releasing there is a delayed exposure after 13 seconds, with exposure time set on knob (8). The speed-regulating mechanism and the self-timer function — as mentioned above — practically free from noise.

We strongly recommend to practise shutter handling until you become fully acquainted with it. We repeat concisely the phases as follows:

Fast speed exposures of $\frac{1}{25}$ to $\frac{1}{1000}$ sec.

Lift fast speed knob (8), turn it into the direction of the arrow, make it snap into position, when exposure time and red mark are opposite each other.

Long exposure times (T and B)

Lift fast speed knob (8), turn it into the direction of the arrow, make it snap into position when T or B have come to the red mark. B = shutter remains open only as long as shutter release knob (3) is being pressed. T = shutter opens by the first pressure on the release knob (3) and is closed by a second pressure.

Slow speed exposures of $\frac{1}{5}$ sec. up to 12 sec.

Wind shutter (= swing around film transport lever (6) as far as the stop), set fast speed knob (8) on T or B, as described above, wind slow speed knob (17) as far as it will go, lift knob (17), turn it until black figure and red mark are opposite each other, make knob (17) snap into position.

Self-timer with delay of 13 sec. for exposures of $\frac{1}{5}$ up to 6 sec.

Wind shutter, set fast speed knob (8) on T or B, as described above, wind slow speed knob (17) as far as it will go, lift knob (17), turn it until selected red figure and red mark are opposite each other, make knob (17) snap into position.

Self-timer with delay of 13 sec. for exposures of $\frac{1}{25}$ down to $\frac{1}{1000}$ sec.

Wind shutter, set fast speed knob (8) for the selected exposure time (e. g. $\frac{1}{50}$ sec.), wind slow speed knob (17) as far as it will go, lift knob (17), turn it until any red figure (preferably $\frac{1}{5}$ sec.) and the red mark are opposite each other, make knob (17) snap into position.

Before each exposure move around film transport lever (6) all the way as far as it will go (See Section B, paragraphs 1 and 2) (Fig. 8). This winds the shutter, the film is advanced by one frame and the mirror is lifted again so that the reflected image is visible.

For picture taking in sequence, it is important that fast speed knob (8) may be operated immediately after moving the film transport lever (6). Therefore, please note that the knob (8) can be set before and after winding the shutter.

Because film advance and shutter winding are coupled, double exposure is normally impossible. If, however, double exposures for certain purposes are wanted, then in such exceptional cases the shutter can be wound without transporting film. After the first exposure turn the fast speed knob (8) with thumb and index of your left hand in the direction of the arrow without lifting it, until you feel it click, while thus winding the shutter, the knob (8) intends to snap back. You must, therefore, while turning, hold the knob (8) firmly.

During intervals between exposures the release knob (3) may be protected by swinging the release lock (3a) over the knob.

D. The lens of the EXAKTA and instructions for focusing

The lenses (25) of the EXAKTA VX are interchangeable. The camera should always be kept with the lens inserted or with a protective cover, which is put into the bayonet mount, to protect it from dust. The front of the lens should be protected by a lens cover which, of course, must be taken off before picture taking. When removing the lens press the bayonet catch (27) towards the lens (Fig. 13). Turn the whole lens to the left (frontal views). Then two red marks (21 and 26) are opposite each other, one on camera body, the other on the lens. Lift the lens from camera. When inserting a lens, the procedure is reversed: After putting the lens (25) into the bayonet mount (red marks (21 and 26) are opposite each other), turn it to the right, until the catch (27) snaps into position.

For critical focusing turn the distance ring (23), until the subject appears needle sharp on the focusing screen in the finder-hood (11). Then you have the lens-to-subject distance on the meter or feet scale of the distance ring (23) opposite the red mark (Fig. 14-16).

By turning the knurled aperture setting ring (24) the diaphragm is adjusted. Turn the ring to the left or to the right, until the stop required is opposite the red mark. The figure on the ring indicates the effective lens opening, i. e.

low figures (2, 2.8, 3.5, 4, etc.) = large aperture = short exposure time,
high figures (22, 16, etc.) = small aperture = long exposure time.

Stopping down one number requires doubling exposure time, stopping up one number cuts the exposure time in half.

Example: If the speed shall be $\frac{1}{50}$ sec. for an aperture of $f/8$, it will be $\frac{1}{25}$ sec. for $f/11$ or $\frac{1}{100}$ sec. for $f/5.6$.

Reduction of lens aperture (higher figures) produces increase of depth of field: Not only the main subject focused at, but also points in front of it and behind gain in sharpness.

Another detail of the depth of field scale (22) on the EXAKTA VX lens: On either side of the middle mark there is a diaphragm scale. On one side you read from which distance sufficient sharpness can

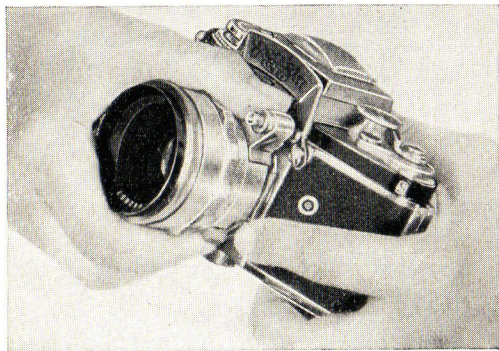

Fig. 13



Fig. 14

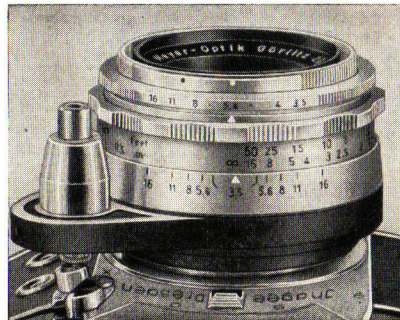

Fig. 16



be expected and, on the other side, the distance is recorded up to which the sharpness will reach (= depth of field range). The respective distance is opposite the diaphragm stop needed. If on one half of the scale the aperture chosen comes to lie behind the infinity sign (∞) — proceeding from the middle —, the sharpness will extend to infinity. Example (see Fig. 14): Lens set at 4 m, diaphragm

Fig. 15

stop 8: range of sharpness from about 2.60 to 8 m using a lens with $f/5$ cm. For a lens with $f/5.8$ cm, the depth of field is somewhat smaller: lens set at 4 m, diaphragm stop 8: range of sharpness from about 2.80 m up to about 7.50 m (see Fig. 15). These distances are measured from the film plane of the EXAKTA VX to the subject.

Some lenses of the EXAKTA VX are provided with a device to "pre-set the diaphragm". The image on the ground glass screen becoming dark when the diaphragm is stopped down, focusing should always be done at full aperture, and the lens should be stopped down thereupon. To avoid the necessity of moving the camera from the taking level in order to stop down the aperture, the "pre-set diaphragm" has an extra stop ring for the diaphragm (e. g. $f/8$) which can be set in advance.

On the majority of these lenses you press back and turn the knurled stop ring behind the diaphragm ring, until the aperture required is opposite the red mark. Then let the knurled ring spring back. The diaphragm ring now stops fast at the "pre-set" aperture and may be turned back to this point without visual control after focusing at full aperture. — Other lenses function similarly except that the knurled ring has to be pressed forward.

As a logical continuation in the development of the "pre-set diaphragm" several of the EXAKTA VX lenses have been equipped with the "automatic diaphragm pre-setting device", a great advantage if you consider that releasing the shutter automatically closes down the diaphragm to the pre-selected aperture. The "automatic diaphragm" has to be wound up as shown in Fig. 17: Move the lever underneath the lens to the right (seen in viewing direction). With the lens at full aperture, the spring device clicks in and the lever automatically jumps back to its original position.

The winding-up process may take place:

a) before selecting the diaphragm stop. In this case, the diaphragm is at full aperture and remains so while the pre-selecting ring (24) is being set. The diaphragm does not close down to the pre-selected stop before the shutter is actually being released;

b) after selecting the diaphragm stop. In this case, the diaphragm is closed down to the pre-selected aperture but will open the moment the automatic pre-setting device is being wound up, snapping in at the widest aperture.

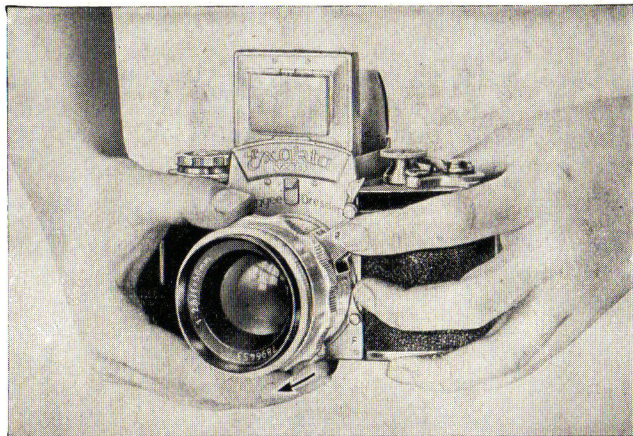

Picture composition and sharpness have to be adjusted with the lens wide open. On depressing the release knob (24c) belonging to the lens (in front of the shutter release knob (3) on the camera) you automatically close down the diaphragm to the pre-selected aperture, whereupon the shutter is immediately released.

To make sure that the plunger of the lens release (24c) will push the shutter release knob (3) far enough

Fig. 17

into the camera, you may find it necessary to adjust it to the proper length. This is done by removing the lens from the camera and turning the plunger as required with a screw driver. The lens release knob (24c) is equipped with a thread to accept a wire release.

Adjustment of the iris diaphragm on these lenses takes place as follows:

Press diaphragm setting ring (24) in the direction of camera body and rotate it until the desired number stands against the red mark. Then let the diaphragm ring (24) jump back to its original position. (The larger apertures permit setting also between two diaphragm numbers — half a stop larger or smaller.) As already mentioned, the "automatic diaphragm", when adjusted, clicks in at the widest aperture, and only at the moment the shutter is being released, the diaphragm springs back to the pre-set stop. As long as the "automatic diaphragm" is not wound up, the diaphragm can, at any time, be set to the desired stop by actuating the setting ring (24), whereupon the reflex image in the EXAKTA VX will immediately reveal the change in brightness and depth of field.

At the lenses with "press diaphragm" the front mount ring for using the press diaphragm is turned so that the red dot is opposite the red index triangle. Then the diaphragm ring is set on the diaphragm number desired (Fig. 16). When pressing the release button of the lens, the diaphragm closes as far as the pre-set aperture. When the pressure diminishes after the shutter having run down, the diaphragm opens again as far as the widest aperture. If, however, the front mount ring is turned so that the black dot is opposite the red index triangle, the diaphragm with the diaphragm ring can immediately be set on the aperture desired. That is necessary for focusing trials or longer exposure times. Into the releasing button of the lens a flexible cable release can be screwed, too.

E. How to use and exchange the finder-hood

A bright ground glass image is visible in the finder-hood (11) of the EXAKTA VX. Because it is magnified on the ground glass to a high degree, critical focusing is easy. For additional accuracy in focusing whenever required, the built-in magnifier (13) is used: Move the button (14) upwards along the guide slot in the finder-hood frame (Fig. 17), while gently holding your thumb on the finder-hood front wall. To bring the built-in magnifier back to its neutral position, move button (14) downwards with your index finger.

The excellent definition of the ground glass image facilitates composing and determination of the picture. While stopping down the diaphragm, you can even observe the varying effect of the depth of field.



Fig. 18

Focusing should always be done at full lens aperture and the diaphragm stopped down afterwards. The reflex image in life colors renders the exact effect of the final color photograph. Normally the EXAKTA VX is held at chest-level (Fig. 19). Illustration 20 shows how to hold it when the built-in magnifier is used. When holding the camera at eye-level, vertical pictures at right angles can be taken with the finder-hood (Fig. 21), so that the photographer can work without being observed (Fig. 22). The Penta Prism (see Section F) permits vertical pictures in direct vision showing an upright and laterally correct image.



Fig. 19

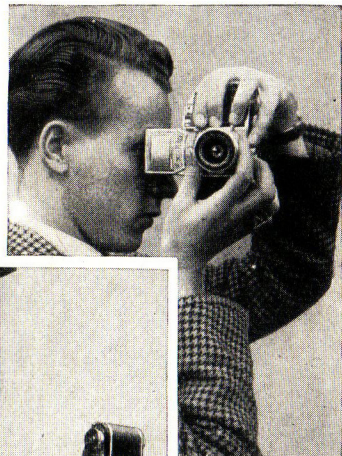

Fig. 21



Fig. 20



Fig. 22



Fig. 23

Control of the ground glass image is also possible, when holding the camera above your head, taking it upside down and looking up into the finder-hood (Fig. 23). Work this way when shooting from behind a wall, over a crowd, etc. The finder-hood (11) can also be converted into a frame-finder (Fig. 24): Bring the focusing magnifier (13) into working position, swing the protective cover (12) upwards, look into the rectangular opening of the finder-hood back wall (15) (Fig. 25). The rear picture frame must exactly be limited by the frame in the front part of the finder-hood, then the image visible in the frame finder corresponds to the future photograph. This method is recommended for sport shots etc. (unless the Penta Prism is used), but can not be applied for picture taking at distances shorter than about 3 m, because of parallax. The measurements of the sportfinder fit only lenses of 50 mm and 58 mm.

For interchanging, the finder-hood (11) must be closed. Move down the finder-hood release (9) and lift the closed finder-hood (Fig. 26). When replacing the finder-hood, insert it carefully in a perpendicular direction and press it down, until the click of the catch is heard.

Do not apply force!

Weak-sighted persons may or may not use their short-distance glasses for focusing with the finder-hood.

Fig. 25

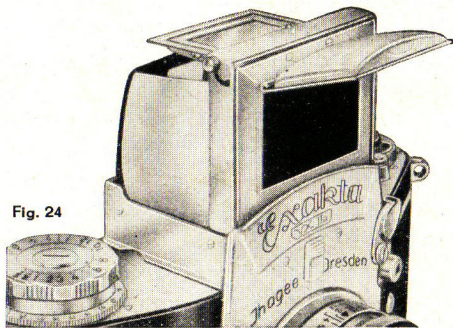
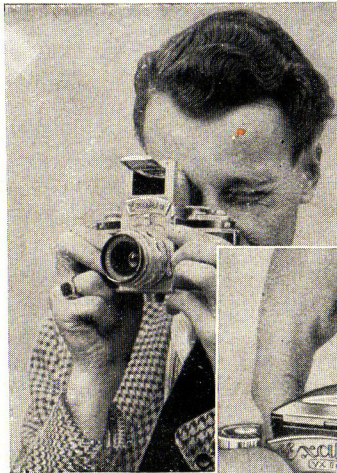

Fig. 24

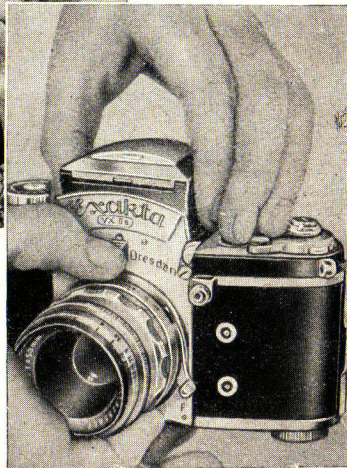

Fig. 26



Fig. 27

*) The Exposure Meter Insert is a completed Penta Prism and is used as a focusing system exactly as the Penta Prism. For operating the Exposure Meter please demand our special instruction.

F. How to use and exchange the Penta Prism and the Exposure Meter Insert *)

The EXAKTA VX is a multi-system camera, because focusing systems are interchangeable as the circumstances may require. As described in the preceding Section E, the finder-hood can be removed and replaced by the Penta Prism (Fig. 28). This Special Prism (43) (also see Fig. 1), the most important supplement of the EXAKTA VX, is supplied separately as an accessory and is foremostly designed for sports shots, fast moving subjects, press work, etc. With the Penta Prism inserted the camera is held at eye-level (Fig. 27) and the object to be photographed is viewed straight through the finder. To take horizontal pictures keep the camera with its back (40) against your forehead, as Fig. 29 shows (advantage: this way the camera can be operated fast and the lens comes to lie higher when you are forced to photograph over a crowd etc.).

The Penta Prism always shows an upright and laterally correct reflex image which corresponds to nature in all details regardless whether it is a vertical or horizontal picture (Fig. 30). The image in the Penta Prism moves in the same direction as the object. Therefore, with the camera at eye-level it is easy to follow

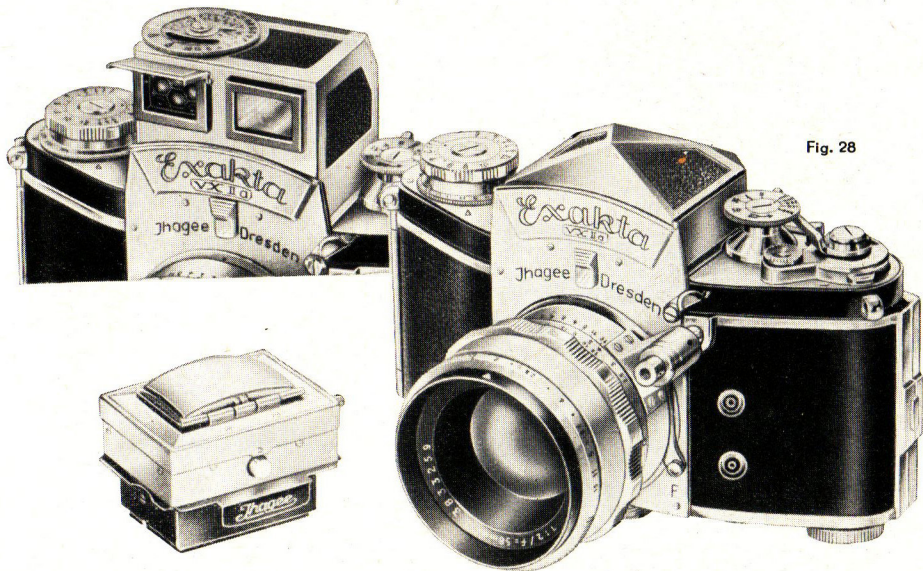
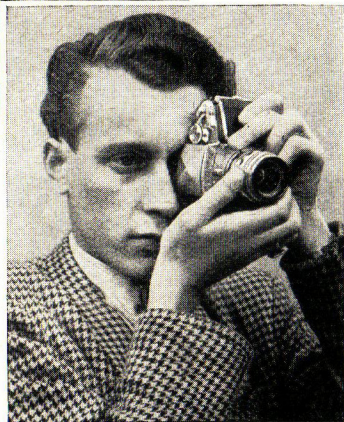

Fig. 28

Fig. 29



moving objects. If during rapidly moving sport events $\frac{1}{1000}$ sec. of the focal-plane shutter is not sufficient, the EXAKTA VX can, while focusing, be moved with the action of the object. That is also possible with longer exposure times (up to $\frac{1}{100}$ sec.). In this case the background, it is true, becomes blurred, but the object shows an excellent definition despite fastest movement.

To install and remove the Penta Prism (43) proceed as with the finder-hood (11) (see Section E).

Make sure that the Penta Prism is inserted in its place in a strictly perpendicular position. Never use force!

Weak-sighted persons will focus best with the Penta Prism by using long-distance glasses. A rotatable view-finder eye-piece is available for the Penta Prism (see Fig. 60) into which a suitable eye-glass can be inserted by an optician, for critical focusing without further help.

Fig. 30

G. To load the EXAKTA VX

The EXAKTA VX takes standard 35 mm film in cartridges with up to 36 exposures $1\frac{1}{2} \times 1$ in (24 x 36 mm) on a strip of the usual length of 5 ft. $5\frac{1}{8}$ in (= 1,60 m). The film is available in either factory-filled cartridges, or empty cartridges are loaded with refill film or bulk film. For further details ask your photo dealer. The take-up spool for the EXAKTA VX does not require special trimming of the film end. When using an empty film cartridge for taking up, the film tongue must be trimmed to fit the spool (see Fig. 31).

To load the camera do as follows:

Open the back, as described in Section A. Pull out the film rewinding knob (37) rigorously as far as it will go. Place the cartridge with the unexposed film into the film chamber (39). Return the film rewinding knob (37) into position, if necessary, by slightly turning its rim!

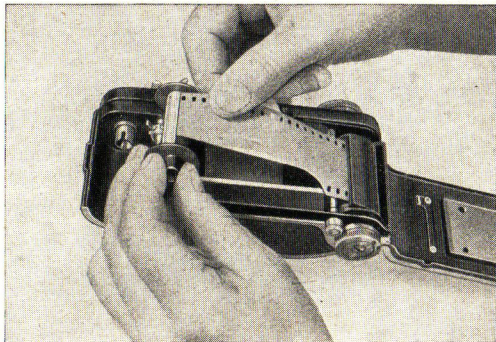
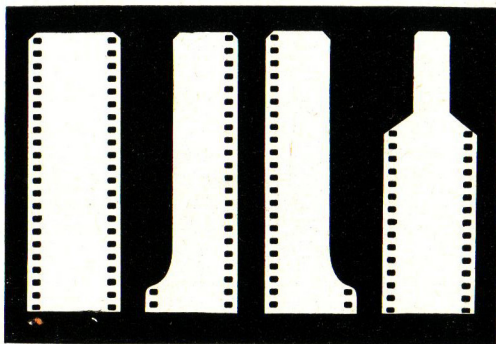
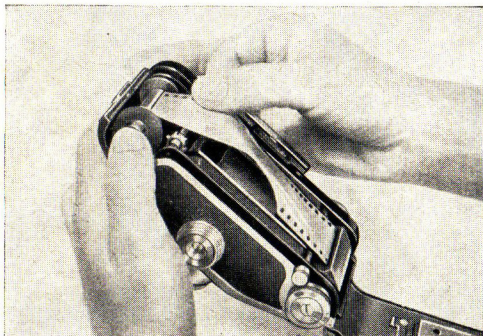

Fig. 32

Fig. 33



Attention: By any means don't press the central part of film rewinding knob (38), otherwise the film transport will be stopped! When loading we recommend removing the take-up spool (29) from the camera (Fig. 32) for fastening the film end to it. Take the film end protruding from the cartridge under the holding spring of the take-up spool (29) in the film chamber (30) and push it securely, the emulsion side of the film facing the lens, as shown in Fig. 32. Conduct the film across the film track with the two film guides (32) and replace the take-up spool into the camera. Take care that the fork of the film transport lever (6) engages properly the bar in the hole of the spool.

It is also possible to fasten the film on to the take-up spool without removing the spool from the camera, whereby the holding spring must lie upwards (Fig. 33). When you fasten the film end to the take-up spool (29), place the camera, if possible, on a solid surface and make sure that the camera back is not hanging down.

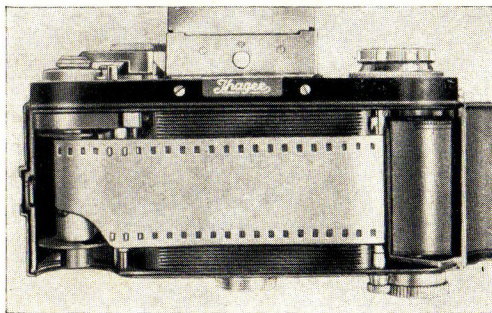

Fig. 34

Fig. 35

The film must run perfectly straight and flat on the film track and engage properly both sprockets (31) (Fig. 34).

Again: Make sure that the cogs of the film transport sprockets engage both sides of the film perforation. Close and lock the back cover (40) (see Section A). Before closing be sure that take-up spool and film are in proper position.

Now two "blind" exposures are to be made: Open finder-hood (11) as described in Section B. If there is no image visible in the finder-hood, move around film transport lever (6) till the stop. Release by pressing the shutter release knob (3): the first "blind" exposure. Wind (6) and release again: second "blind" exposure. Wind film transport lever (6) a third time as far as it will go: an unexposed film piece is brought into position before the film gate (33), ready for the first "real" exposure, after the film frames exposed when you loaded the camera have been taken up. Finally, set exposure counter (5): Turn the little knob (5a) of exposure counter (5) with your left

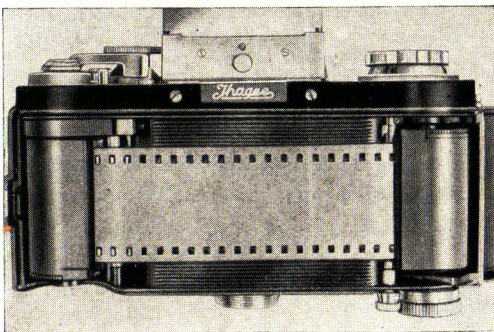
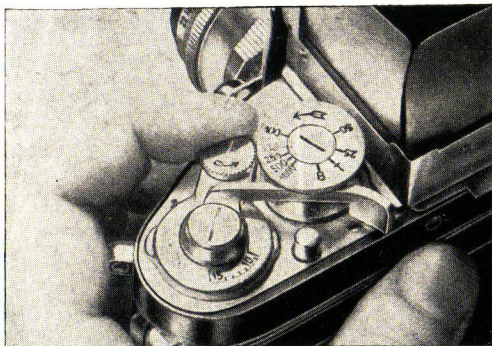

Fig. 36

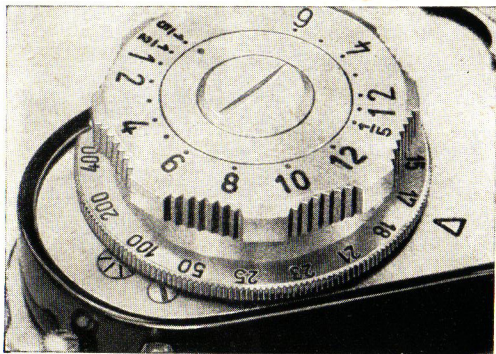

Fig. 37

lever (6) engages the bar inside of the spool and the film is wound up, emulsion side inwards.

Illustration 36 shows the way the film must take.

To control the film transport there is the control disc (rotating film speedometer) marked by a red cross (19). The cross turns, when the spool of the cartridge rotates (Fig. 37).

To assist your memory there is, on the slow speed knob (17), a film speed indicator (film speed recorder) (18). On the EXAKTA VX IIa this indicator has been adapted to suit international film gradations. It should be set immediately after film loading, being rotatable in anticlockwise direction

index finger (see Fig. 35) in the direction of the arrow, until you will see a dash before No. 1 (The image counter counts each picture after the exposure, therefore, points to 1 after the first exposure). Now the camera is ready for picture taking.

If you prefer not to rewind the exposed film into the cartridge after the last (36th) exposure, but to take it up in another cartridge, the procedure is the same as described above. Remove take-up spool (29) and replace it with an empty but unobjectionable cartridge. Open the cartridge and fix film end to the spool. Then place the cartridge so, that the fork of the film transport

by means of its milled edge. It is engraved with various numeral values ranging from 6 to 400 and with four alphabetical characteristics. The numerals refer to the sensitivity of black-and-white films (e. g. 100 = 100 ASA, 17 = 17⁰ DIN, etc.), whereas the letters have the following meaning:

- C (black) = Color reversible film for daylight
- C (red) = Color reversible film for artificial light
- NC (red) = Color negative film for artificial light
- NC (black) = Color negative film for daylight.

According to the film you have in your camera set the respective numeral or letter opposite the triangle (∇) engraved on the covering plate. You can then always see which film was placed into the camera, even in cases of longer intervals between snapshooting.

Two examples:

Kodak Super XX with Asa 100 = the "100" of the film speed recorder stands against the triangle (∇)
Anscochrome daylight film = the black "C" of the film speed recorder stands against the triangle (∇).

H. To change films

a) When using the take-up spool:

One film length of 1,60 m will generally take more than 36 exposures.

Even if the exposure counter (5) points to "36" (one dash before "1"), one or two more exposures can be made, until the film transport lever (6) cannot be wound any more. Here it can happen that the lever (6) gets stuck midway. In this case the film rewinding stud (7) must be depressed and the film

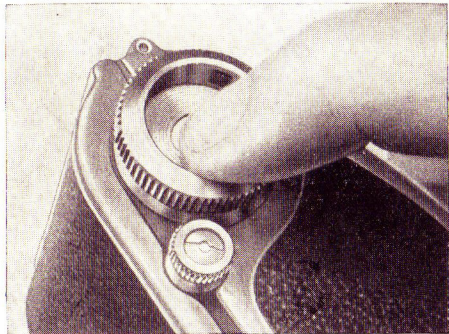

Fig. 38

transport lever (6) swung around to the stop. The lever (6) can now return into its neutral position, and the stud (7) automatically springs up again as soon as the pressure ceases.

Film rewinding is done as follows: Hold the camera with your left hand and press down the stud (7) during the whole rewinding process (Fig. 39). With your right index finger press in the central part (38) of the film rewinding knob (37) as far as it will go (Fig. 38). Now the fork of the film rewinding knob catches the bar of the film spool and by uniformly turning the rewinding knob (37), the film is rewound into the original cartridge. You can observe that the film rewinds all right, when you see the control disc (19) (Fig. 36 page 27) and the axle of the film transport lever (6) turning (Fig. 40). While rewinding, the axle of the take-up spool turns in opposite direction of the lever (6). Once the film is rewound, the rewinding axle stops rotating. As soon as the stud (7) has sprung back into its original position, the film can be advanc-

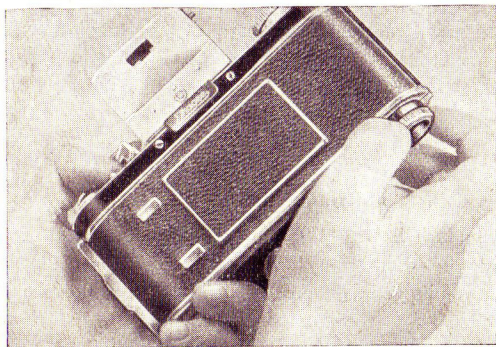

Fig. 39

Fig. 40

ed as usual. Now open the EXAKTA VX (see Section A), pull out the film rewinding knob (37), remove the cartridge containing the exposed film (see Fig. 41). Press the exterior ring of the rewinding knob (37) against the camera.

b) When using a take-up cartridge:

If the exposed film is wound into a cartridge instead of onto the take-up spool, rewinding is not necessary. As soon as the film is all used up and the film transport lever (6) cannot be moved any more, the film is cut off with the built-in knife (34). Loosen the knife release (35) by turning it to the left. It is fastened on one end of a thin bar, on the other end of which the cutting knife (34) is fixed. If you draw out the knife release (35) from the camera body (about 4 cm) (Fig. 42), the film cutter (34) crosses the film track and cuts off the film strip. Afterwards push the knob (35) back into the camera by turning it to the right. With two "blind" exposures the filmend is drawn into the cartridge

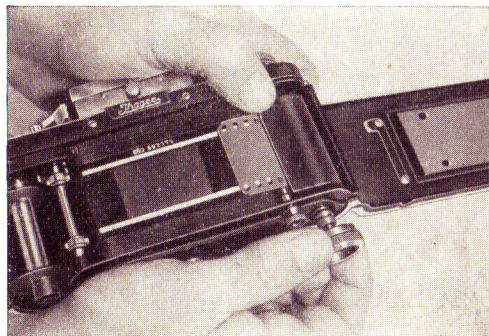
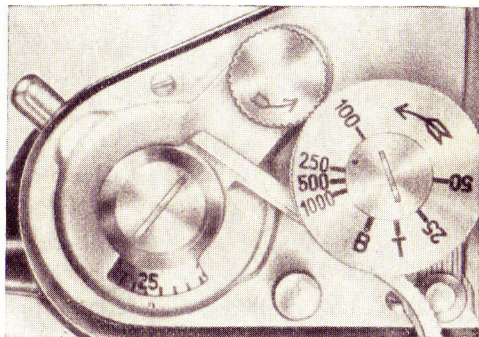

Fig. 41

so that even the last exposure will be safe from light. Now open the camera as described before and remove the cartridge containing the exposed film.

Do the same if a piece of the film, e. g. after the 10th, 15th or 20th exposure shall be removed from the EXAKTA VX in order to be developed. You must, of course, again fasten the fore-end of the unexposed film either on the take-up spool or in a take-up cartridge. When cutting off film parts from a take-up spool, you must, of course, go into the darkroom, in order to remove the exposed part of the film.

Being precision-built, as mentioned in the beginning, the EXAKTA VX requires good care besides right handling, which, needless to say, applies also to the accessories.

For all, that is so far essential, see Section L, page 58! It is highly recommended for every owner of an EXAKTA VX to care for these few rules.

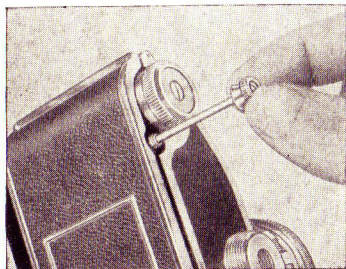

Fig. 42

J. Flash technique

The EXAKTA VX IIa has three synchronized contacts for flashlight exposures:

One contact X for open flash with flash tubes and flash bulbs, two contacts M and F for the use of flash bulbs at short shutter speeds. The flash-bulb synchronization M and F is adjusted according to the firing delay of the flash bulbs.

The **M contact** closes the circuit approximately 15 milliseconds before the first shutter curtain opens the shutter. The light curve of certain flashes will thus coincide with the travelling of the shutter. This contact is used for synchronizing flash bulbs with a longer flash duration (e. g. General Electric, Westinghouse, Philips PF 45E). This synchronization allows for short shutter speeds down to $1/1000$ sec. (see table a).

The **F contact** closes the circuit approximately 11 milliseconds before the shutter is fully opened. This contact is designed for the small, short-burning flash bulbs (e. g. Amplex No. 5, Dura Flash No. 5, General Electric PH 5, Westinghouse No. 5, Philips PF 5). The shutter has to be set to $1/25$ sec, (see table b).

The **X contact** permits the use of all types of flash bulbs with a flash duration of $1/5$ sec. and longer. In this case, the shutter speed is determined by the flash duration of the flash bulb (see table c). The X contact is also intended for the synchronization of flash tubes (see page 38).

Please refer to the following tables for information regarding the use of particular flash bulbs in connection with the flash contacts on the EXAKTA VX IIa:

Should you meet with any difficulty when using flash bulbs (for instance, faulty contact in the lamp base, etc.), remove the flash bulb after the shutter has travelled its course. Do not insert a new lamp before the shutter has been rewound.

In fact, changing of lamps must take place only with the shutter wound up.

Tables explaining the three Flash Contacts of the EXAKTA VX II a

a) Full synchronization: Connect the cable cord to the M contact!

EXAKTA VX II a shutter set at	Amplex No. 31	Dura Flash No. 31	General Electric PH 31	Westinghouse No. 31	Philips PF 45 E
$1/1000$	+	+	+	+	+
$1/500$	+	+	+	+	+
$1/250$	+	+	+	+	+
$1/100$	+	+	+	+	+
$1/50$	+	+	+	+	+

b) Open flash technique: Connect cable cord to F contact and set shutter to $\frac{1}{25}$ sec.!

For use with small, short burning flash bulbs.

Shutter setting (not exposure speed)	Amplex		Dura Flash		General Electric		Westinghouse		Philips	
	Type	Exposure speed (\sim flash duration)	Type	Exposure speed (\sim flash duration)	Type	Exposure speed (\sim flash duration)	Type	Exposure speed (\sim flash duration)	Type	Exposure speed (\sim flash duration)
$\frac{1}{25}$ sec.	No. 5	$\frac{1}{100}$	No. 5	$\frac{1}{100}$	PH 5	$\frac{1}{100}$	No. 5	$\frac{1}{100}$	PF 5	$\frac{1}{100}$

c) Open flash technique: Connect cable cord to X contact and set shutter to $\frac{1}{5}$ sec. or a slower speed!

For use with all flash bulbs on the market. For American flash bulbs please note the following data:

Shutter setting (not exposure speed)	Amplex		Dura Flash		General Electric		Westinghouse		Philips	
	Type	Exposure speed (\sim flash duration)	Type	Exposure speed (\sim flash duration)	Type	Exposure speed (\sim flash duration)	Type	Exposure speed (\sim flash duration)	Type	Exposure speed (\sim flash duration)
$\frac{1}{5}$ sec. and longer	SM	$\frac{1}{200}$	SM	$\frac{1}{200}$	PH/SM	$\frac{1}{200}$	SN	$\frac{1}{200}$	PF 1	$\frac{1}{100}$
	No. 5	$\frac{1}{100}$	No. 5	$\frac{1}{100}$	PH 5	$\frac{1}{100}$	No. 5	$\frac{1}{100}$	PF 5	$\frac{1}{80}$
	No. 22	$\frac{1}{50}$	No. 22	$\frac{1}{50}$	PH 22	$\frac{1}{50}$	No. 22	$\frac{1}{50}$	PF 60	$\frac{1}{50}$
	No. 50	$\frac{1}{25}$	No. 50	$\frac{1}{25}$	PH 50	$\frac{1}{25}$	No. 50	$\frac{1}{25}$	PF100	$\frac{1}{45}$

For best results with the flash-bulb synchronization, the **Ihagee flashgun** (Fig. 43) is available. It consists of the elegant plastic-body with Extension-Lamp-Holder for flash bulbs of all sizes and with all sorts of bases, folding reflector, metal rail in order to connect Flash Gun and camera as well as cable. The Ihagee Flash Gun is adjusted for Capacitor Ignition and provided with a Hearing-aid Battery of 22,5 V. Here you must pay attention to right poling. When pressing the red button of the Flash Gun, a built-in pilot lamp is flashing up, thus showing readiness for action. You will find further details in a special Instruction for use.

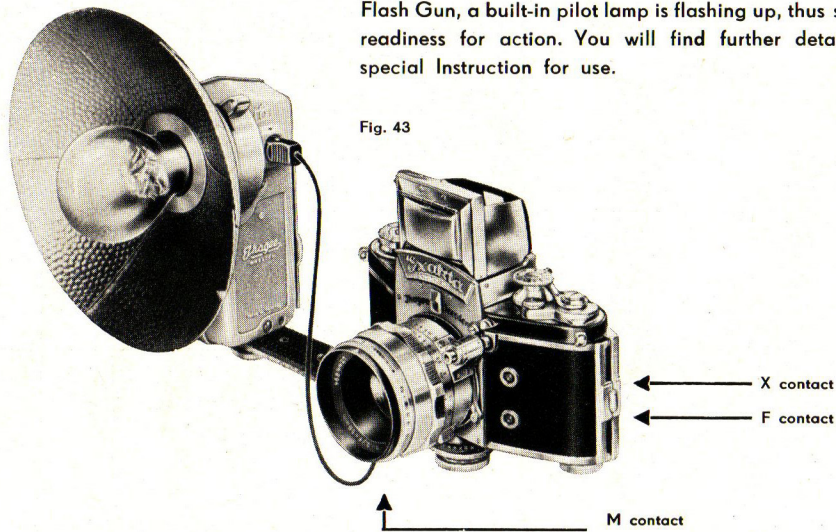

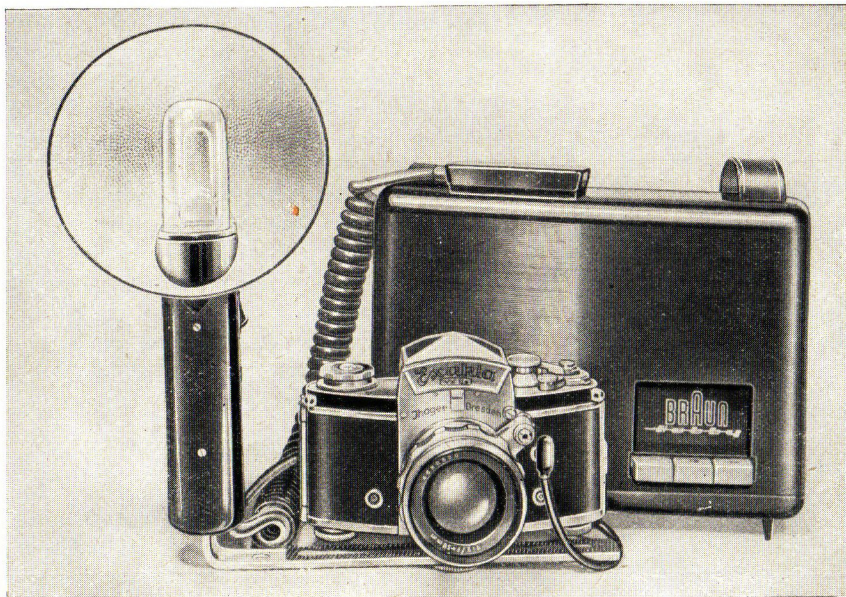
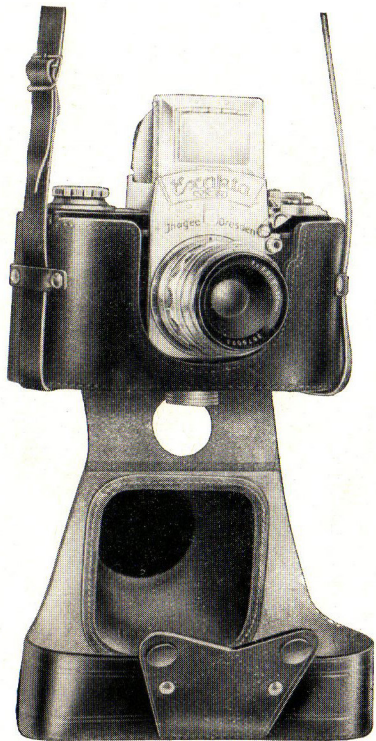

Fig. 44



The Electronic Contact makes it possible – as the name says – to use the EXAKTA VX IIa also with electronic units (Fig. 44). For this purpose there is the third socket X on the EXAKTA VX IIa. This socket accepts the cable cord of the electronic unit. Electronic flashes are ignited at shutter speeds of $1/50$ sec. or longer. The flash-tube synchronization closes the circuit after the first shutter curtain has crossed the entire film gate. The effective exposure time is determined by the flash tube and is usually $1/500$ to $1/5000$ sec., depending on the type of flash tube, which is fast enough to catch subjects moving with extreme speed.

Simultaneously with an electronic flash on the X contact, one flash bulb can be ignited on the M or F contact, should this be considered necessary for any special task.

K. EXAKTA accessories

The EXAKTA Everready Case (Fig. 45) is designed for protecting and easily transporting the camera, which is kept always ready for immediate action. All mechanical parts for picture taking are operated with the camera in the case. The camera is fastened to the case by a retaining screw and the EXAKTA VX can, when in the case, also be screwed on a tripod.

Fig. 45

The neck-strap of the Everready Case makes it easy to carry the camera with you. When you wish to take the camera with you, without the case, you fasten a neck-strap or a cord to the neck-strap eyelets (4).

Many Special Lenses can be used in the EXAKTA VX instead of the normal lens (Fig. 46). The normal lens is removed from the camera as described, and the special lens inserted into the bayonet mount. The EXAKTA VX has the great advantage that, when using special lenses, no special viewfinders, or tables are needed. You focus all the time on the Reflex ground glass just the same way as with the normal lens. There is no difference in exposure time with special lenses as compared with the normal lens at identical diaphragm openings. Expose always as per the aperture setting of the lenses (relative apertures). The distances engraved on the setting scales of the lenses are measured from the film plane of the EXAKTA VX to the subject.

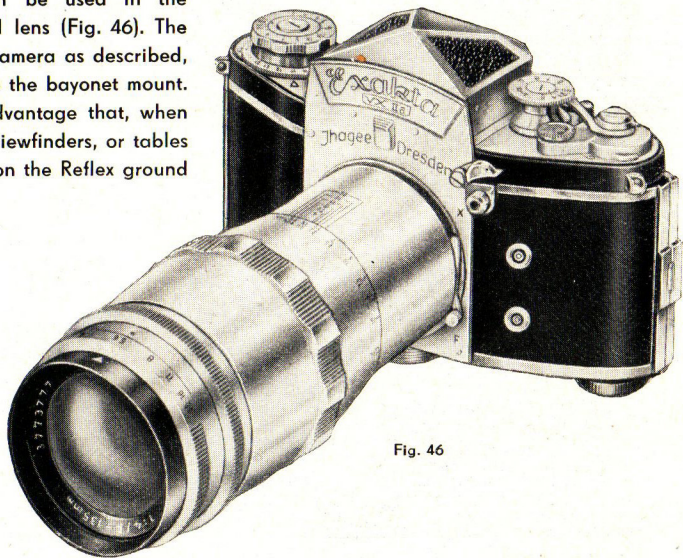
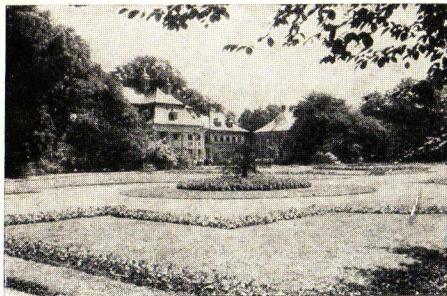

Fig. 46



focal length 35 mm

angle of field 62°



focal length 58 mm

angle of field 40° (normal lens)



focal length 180 mm

angle of field 14°



focal length 500 mm

angle of field 5°

Characteristics:

Short focal distance, large field of view. Covers larger area but everything appears smaller and more distant.

Recommended for:

Architecture, interiors, reproductions in galleries, shooting from short distance.

Recommended for:

Picture taking under poor light conditions and very fast exposures with artificial light.

The following special lenses are available for the EXAKTA VX:

Wide-angle Lenses (see picture at left, page 40)

Name of lens	Speed	Focal length mm	Angle of field (Standard value)	Diameter of the mount mm
Wide-angle lens				
Jena Flektogon AD	f/2.8	35	62°	51
Primagon PD	f/4.5	35	62°	51

Ultra high-speed

Name of lens	Speed	Focal length mm	Angle of field (Standard value)	Diameter of the mount mm
Night lens Jena B..... PD	f/1.5	75	32°	60

Long-focus and Telephoto-Lenses (see pictures, below, page 40)

Name of lens	Speed	Focal length mm	Angle of field (Standard value)	Diameter of the mount mm
Jena Bm..... PD	f/2.8	80	30°	51
Trioplan AD	f/2.8	100	24°	51
Primotar PD	f/3.5	135	18°	57
Jena S PD	f/4	135	18°	51
Jena S PD	f/2.8	180	14°	80
Tele-Megor PD	f/5.5	180	14°	51
Primotar PD	f/3.5	180	14°	70
Tele-Megor PD	f/5.5	250	10°	60
Jena S PD	f/4	300	8°	80
Tele-Megor PD	f/4.5	300	8°	85
Tele-Megor PD	f/5.5	400	6°	85
Tele-Lens.....	f/8	500	5°	80

← Fig. 47

Characteristics:

Long focal distance, small field of view. Covers smaller area but everything appears larger and nearer.

Recommended for:

Sports, animals, portraits, photos of far away objects with telescopic effect, better perspective.

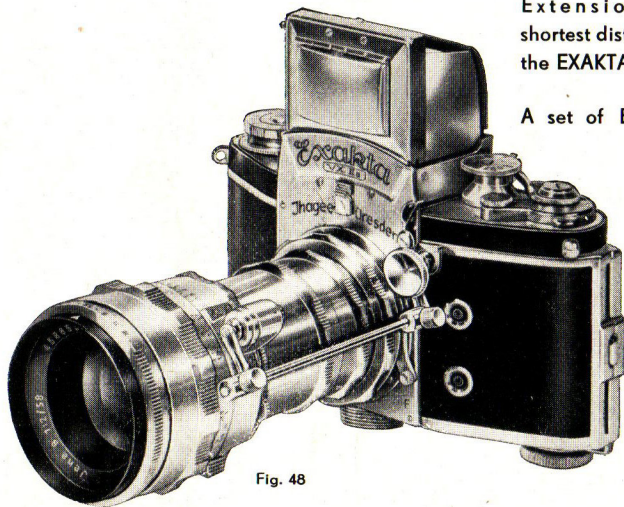

Fig. 48

Extension Increase for Close-ups at shortest distances (Macro-photos) is effected with the EXAKTA VX by the simplest possible means:

A set of Bayonet Adapter Rings and Tubes are inserted between the camera body and the lens (Fig. 48).

A Close-up Bellows Attachment is used for continuous extension increase (see special instruction about our "Vielzweck" = Multi-Combination).

The back Bayonet Ring has a Clamp Ring serving the following purpose:

When using the Bayonet Adapter Rings and Tubes of the EXAKTA VX

in different combinations, the lens is often turned around its axis so that the lens-scales are hard to read. The difficulties in working resulting from this fact can be avoided as follows: First turn the notch of the rear bayonet ring to the left (looking on face of camera), then you can turn the other extension

increases with the lens into the position desired (e. g., when using the Autocouple Extension Release described on page 46, the release buttons of camera and lens must lie exactly one behind the other). By turning the notch for handling to the right the lens and the other extension increases firmly screwed together are fixed in this position. If the front extensions (front bayonet ring or tubes) shall be removed from the rear bayonet ring, turn the notch for handling also to the right, then the extension increases firmly screwed together are fixed in this position. If the front extensions (front bayonet ring or tubes) shall be removed from the rear bayonet ring, turn the notch for handling also to the right, then the extension increases can be screwed out. When inserting and removing all extensions with rear bayonet ring, always seize the notch for handling.

For the minimum extension of 5 mm a Two-in-One Ring (a) is available (Fig. 49). It is made as one piece. The lens is inserted into the front bayonet (watch the red dots just as with the camera), and with the back bayonet the ring is inserted into the camera the same way as a lens. The extension next in length is 10 mm. It is obtained by the two



Fig. 49

Bayonet Rings (b). To insert the lens and the Bayonet Rings together with the lens into the camera do as described before. The two Bayonet Rings, contrary to the Two-in-One Ring, can be separated by unscrewing. For more extension the regular Extension Tubes are screwed between the Bayonet Rings. The shorter the focusing distance, the longer the extension (see the following tables). The Extension Tubes are available in 3 lengths: 0,5 cm, 1,5 cm, and 3 cm (c, d, e). They are available together with the two Bayonet Adapter Rings as a complete set.

The Two-in-One Ring (a) is sold separately.

The effect of the extension increase is seen on the reflex ground glass. Focusing and composing of the image is therefore easy; this is the main advantage of the single-lens reflex camera.

The use of extensions requires increase of the exposure time, as per the following Formula:

$$\text{exposure increase} = \left(\frac{\text{Total extension} = \text{image distance}}{\text{Lens focal distance}} \right)^2, \text{ therefore: } \left(\frac{b}{f} \right)^2$$

Explanation: When using extensions, the total extension is the distance between lens diaphragm plane (the middle of the normal lens) and film plane (= film gate (33)), which is the image distance (b). The focal distance (f) of the normal lens is 5 or 5,8 cm. Devide the higher number by the lower, and the quotient is to be multiplied by itself.

Example: A set of Bayonet Rings and all 3 Tubes with a lens of 5 cm give together 11 cm. The lens has 5 cm focal distance. $11 : 5 = 2,2$. $2,2 \times 2,2 = 4,84$ or rounded up $\times 5$ exposure increase. For instance, the exposure meter indicate $1/25$ sec., as for this example, the exposure time $= 1/25 \times 5 = 1/5$ sec. With the following tables it is easy to determine the increase of exposure time, the distances and the

For lenses with a focal distance of 5 cm.

Extension increase	Subject distance cm	Image distance cm	Scale of Re-production	Exposure Factor
a = 5 mm	55,0	5,5	0,1	1,2
b = 10 mm	30,0	6,0	0,2	1,4
b+c = 15 mm	21,7	6,5	0,3	1,7
a+b+c = 20 mm	17,5	7,0	0,4	2,0
b+d = 25 mm	15,0	7,5	0,5	2,3
a+b+d or b+c+d = 30 mm	13,3	8,0	0,6	2,6
a+b+c+d = 35 mm	12,1	8,5	0,7	2,9
b+e = 40 mm	11,3	9,0	0,8	3,2
a+b+e or b+c+e = 45 mm	10,6	9,5	0,9	3,6
a+b+c+e = 50 mm	10,0	10,0	1,0	4,0
b+d+e = 55 mm	9,5	10,5	1,1	4,4
b+c+d+e = 60 mm	9,2	11,0	1,2	4,8

For lenses with a focal length of 5,8 cm.

Extension increase	Subject distance cm	Image distance cm	Scale of Re-production	Exposure Factor
a = 5 mm	73,1	6,3	0,09	1,2
b = 10 mm	39,4	6,8	0,17	1,4
b+c = 15 mm	28,2	7,3	0,26	1,6
a+b+c = 20 mm	22,6	7,8	0,35	1,8
b+d = 25 mm	19,2	8,3	0,43	2,1
a+b+d or b+c+d = 30 mm	17,0	8,8	0,52	2,3
a+b+c+d = 35 mm	15,4	9,3	0,60	2,6
b+e = 40 mm	14,2	9,8	0,69	2,9
a+b+e or b+c+e = 45 mm	13,3	10,3	0,78	3,2
a+b+c+e = 50 mm	12,5	10,8	0,86	3,5
b+d+e = 55 mm	11,9	11,3	0,95	3,8
b+c+d+e = 60 mm	11,4	11,8	1,03	4,1

scales for close-ups. All these tables contain calculated values, which may differ a little from the real values for the respective focal lengths in consequence of generally admissible tolerances in lens making.

These tables, nevertheless, serve well to find the extensions needed for certain work. The data given are for the lenses with the helical focusing mount set at infinity (∞). Intermediate values are found by critical refocusing at shorter distances. With more tubes you may extend these tables accordingly and magnify pictures as far as practically possible.

Extension increase = Two-in-One Ring	(a)	No 187	Tube 0,5 cm	(c)	No 184
Set of Bayonet Rings	(b)	No 180	Tube 1,5 cm	(d)	No 185
(Back Bayonet Ring with Clamp Ring)			Tube 3,0 cm	(e)	No 186
Subject distance = distance from about lens diaphragm plane					
(Middle of the lens) to subject					
Image distance = extension increase = distance from the middle of the lens (lens diaphragm plane)					
to the film plane (= film gate <33>)					
Scale = image ratio, e. g. 0,8:1 cm of the subject becomes 0,8 cm on the film.					

The Autocouple Extension Release (Fig. 48)

In order to maintain the quick readiness for action of the EXAKTA VX with lenses having the automatic diaphragm setting device, also when using intermediate rings, you will need the "Ihagee Autocouple Extension Release". The insertion of Bayonet Rings and Tubes for close-up work naturally interrupts the direct connection of the release knobs (see pages 16/17). This connection is restored in quite a simple manner by the Autocouple Extension Release. Precise instructions for using this accessory equipment are supplied with each unit.

The Two Microscope Attachments (Fig. 50 and 51) are for installing the EXAKTA VX on a monocular microscope with tubes of 25 mm diameter. With either attachment the camera is put over the tube of the microscope, after removing the camera lens, and operating with the microscope eyepiece and objective (sometimes with the objective alone, see Fig. 54): Then focusing is easy and simple with the reflex system.

Microscope Attachment, Type 1 (with hinged clamp) (Fig. 50): To fix the camera to the top part of the attachment, put the Bayonet Ring into the camera bayonet the same way as a lens. In order to connect the whole combination — camera and attachment — with the microscope, first remove the ocular from the microscope tube. Then put over camera and attachment, replace the ocular into the draw-tube, and fasten the microscope attachment to the microscope tube by a slight turn of the clamping screw. With the hinge the camera can always be tilted to the side, when photographic work shall be interrupted, or to change the eye-piece for a different magnification for resuming visual observation (see Fig. 52).

Microscope Attachment, Type 2 (in Quick-Change-Mount) (Fig. 51): Contrary to the Microscope Attachment, Type 1, where the top and bottom parts are connected by a hinge, both these parts of Type 2 can be separated. The camera comes on the top part as described. In order to fasten the bottom part to the microscope, loose the Quick-Change-Mount and, thus, separate the top from the bottom part (Fig. 51). Loose the knurled screw and lift the top on this side out of its mount so that



Fig. 50

Fig. 51

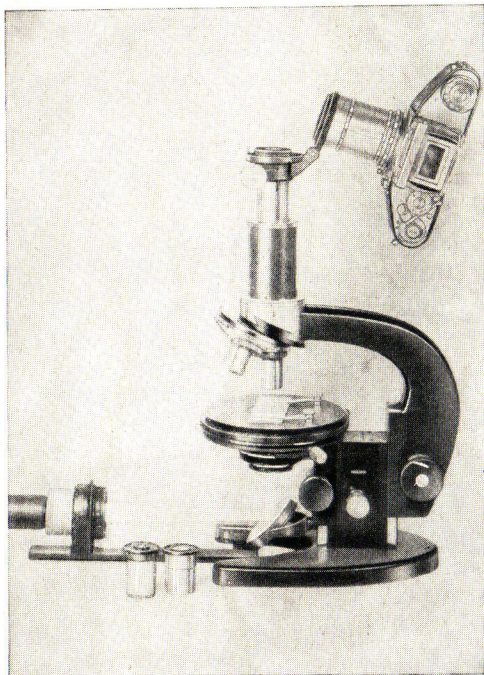

you may draw it from under the two latches on the opposite side. After removing the ocular from the microscope, push the bottom part over the microscope tube, replace the ocular into it and fasten the bottom part on the notch-ring by turning to the left. The top part of the microscope attachment with the camera is inserted into the Quick-Change-Mount. First shift the conus under the two latches, then let it slide in on the opposite side. Finally, by tightening the screw, secure the top part in the mount safely (Fig. 53).

The top part conus of Type 2 of our microscope attachment is also adaptable to the modern microscopes. Remove the tubes and the eye-piece from the microscope and insert instead the EXAKTA VX with the top part only of the micro-attachment into the change-mount of the microscope's tube support (Fig. 54). It is also possible to take macrophotographs — applying the lower magnifications and using the microscopic objective alone (the Microtars are especially qualified for this purpose).

Fig. 52

For Macrophotography and Photomicrography the Lens Magnifier will be used for better focusing and observing instead of the finder-hood or Penta Prism. The Lens Magnifier is fitted with an EXAKTA lens or the "additional lens" which serve as a magnifier. More details are given in our special instruction booklet "Macro-Microphotos". Photomicrography is an interesting special branch which, however, can only be mastered after having thoroughly studied the detailed technical literature. Your photo-dealer will recommend you with pleasure suitable books (see page 59!), our department "Technical Service", too, is at your disposal with information at all times.

Special Types of Focusing Glasses. When taking micro-photographs it is often desirable to examine the image on a ground glass, and at the same time focus critically through a clear center spot directly from the microscopic image. That is easily possible with the alternative focusing systems of the EXAKTA VX, because you can have ground glasses with clear center spots

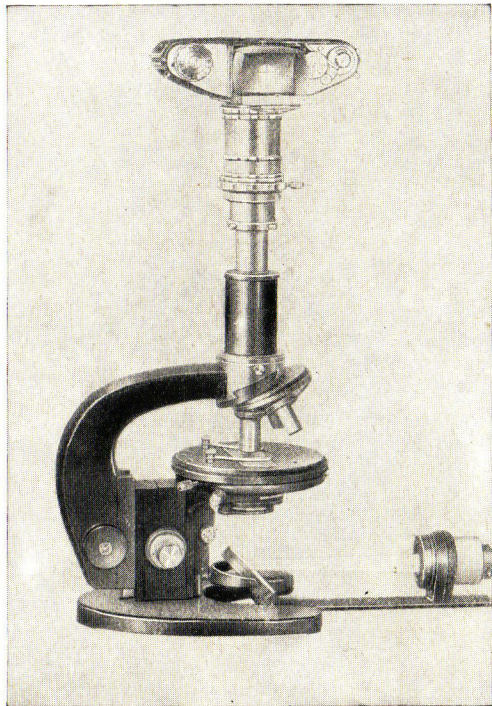
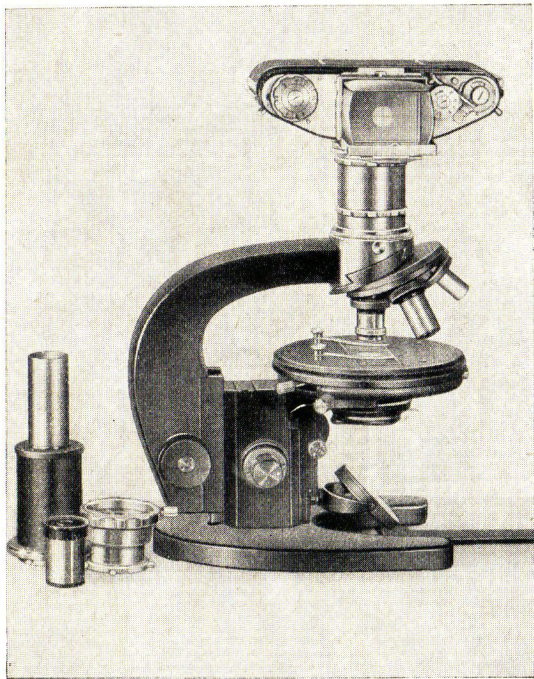

Fig. 53



both for the finder-hood, the Penta Prism, the Exposure Meter Insert, and the Lens Magnifier. However, since you may not intend to use all the time a ground glass with clear center spot, when taking other photos, we offer these special ground glasses separately.

In the reflex finder-hood the ground glass is on the bottom of the solid lens which can be removed from the finder-hood by loosening the two fastening screws. The desired special focusing glass can then be inserted. However, for convenience' sake, we would recommend purchasing a complete extra finder-hood with the special glass right from the beginning, the difference in price not being very considerable (Fig. 55). The Penta Prism, the Exposure Meter Insert, and the Lens Magnifier permit to change the ground glass lens with little effort (grasp it by the open spaces of the longitudinal sides taking it out). Therefore, it is necessary to procure a lens alone (Fig. 56) of the desired type.

Fig. 54

Fig. 55

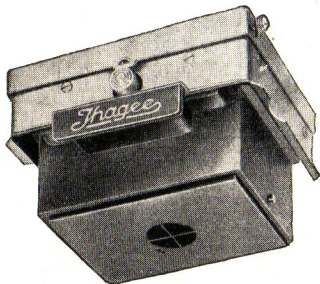
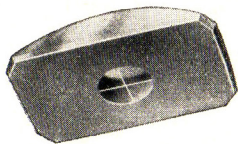

Fig. 56



The following special glasses are available:

- a) Reflex finder-hood with ground glass and clear center spot of 3 or 10 mm diameter (both with hairline cross in the clear center spot),
- b) Reflex finder-hood with ground glass fully clear and hairline cross,
- c) Lens for the Penta Prism with ground glass and clear center spot of 3 or 10 mm diameter (both with hairline cross in the clear center spot),
- d) Lens for the Penta Prism fully clear with hairline cross.

Custom Made Glasses for technical photos, architecture, reproductions etc., can be manufactured according to your wishes (e. g. with etched rectangles, cm or mm graduations etc.). Please apply to our "Service Department"!

In order to facilitate focusing with the Penta Prism, the Exposure Meter Insert, and the Lens Magnifier use the Distance Meter. It shows halved images of the subject in one measuring range. When focused inaccurately, the image parts are displaced against each other; when focused critically, they are seen exactly matching each other. Focusing requires a wide lens aperture (no less than 1:5.6).

The Ihagee Macro-Micro Photometer facilitates determining the exposure time in Macro- and Micro-photography. A Selenium-stoplayer element is intercalated direct in the path of rays, thus measuring the light efficient in the camera. A marketable microamperometer or light-galvanometer are necessary for it.

The Stereo-Attachments for the EXAKTA VX (Fig. 57) are for taking three-dimensional stereo-photos. The large Stereo-Attachment makes it possible to take pictures at a distance of from ∞ (infinity) down to 2 metres, the small one to take such photos at a distance of from 2 m down to 0,15 m. Both these Stereo-Attachments are made to be screwed into the front mount of the normal lenses (focal distance of 5 cm and 42 or 32 mm front mount). When ordering indicate the lens you have! The three-dimensional effect is brought about, similarly to the human eye, by two pictures: one showing a little more of the left hand side of the subject, the other somewhat more of its right hand side. With a Stereo-Attachment one basic picture of the subject is reproduced simultaneously twice by two separate prism systems. The image of 24×36 mm gives two upright pictures 18×24 mm, covering 15×22 mm (Fig. 58). The right picture is reflected into the lens by the left prism, and the left picture by the right prism (crosswise). When printing or enlarging the negatives you don't have to switch the two pictures. Transparencies made from the stereo-photos can be observed with our Stereoscopic Viewfinder "Stereoflex" (see Fig. 57) or in other stereoviewers. It is also possible to project the transparencies with a special "Stereo projector" or by a miniature projector, fitted with a stereo projection attachment, and to view them stereoscopically (three-dimensionally) through available polarizing spectacles. On request our "Service Department" will give further information.

The Stereo-Attachments are screwed into the front mount of the lenses and fixed by turning the stop ring in the opposite direction, as soon as the separation line runs exactly perpendicular, i. e. parallel with the longitudinal sides of the images 18×24 mm. On the ground glass you already see two

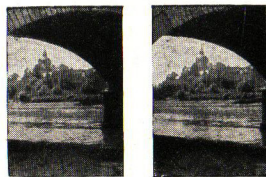
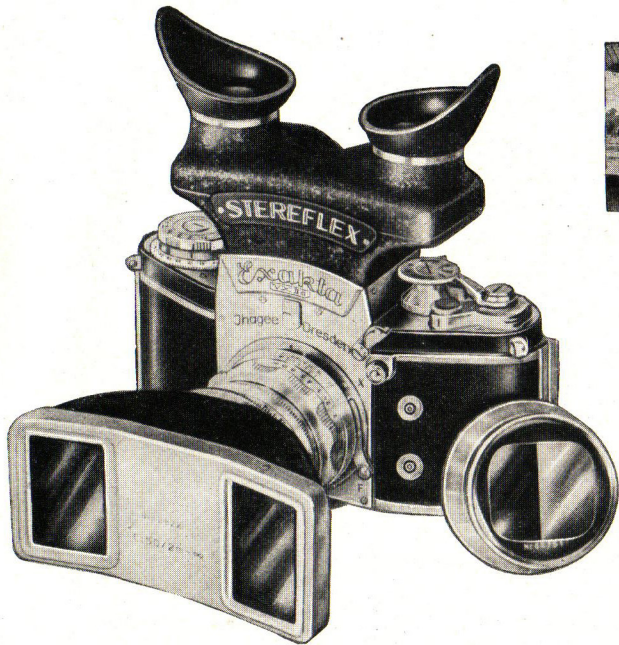

Fig. 58

Fig. 57

rectangular partial images. Perpendicular setting is facilitated by watching the ground glass. The limits of application of the two Stereo-Attachments must be carefully followed. When taking close-ups of from 0,15 to 2 m distance the narrow space between the prism systems of the small attachment is sufficient whereas pictures of from 2 m distance up to ∞ require the larger attachment, in order to obtain the necessary three-dimensional effect. When using the Stereo-Attachments the exposure time is to be increased 1,5 times. Because the two pictures stand side by side, you can use the EXAKTA VX in the horizontal position only. The stereo-photos are always upright.

In order to be able to pre-judge the effect of the future stereo-photo on the ground glass you insert into your EXAKTA VX the mentioned stereo-viewfinder "Stereflex" instead of the reflex finder hood, of the penta prism, or the Exposure Meter Insert. The stereo-viewfinder may also be used to view the finished transparencies. For this purpose

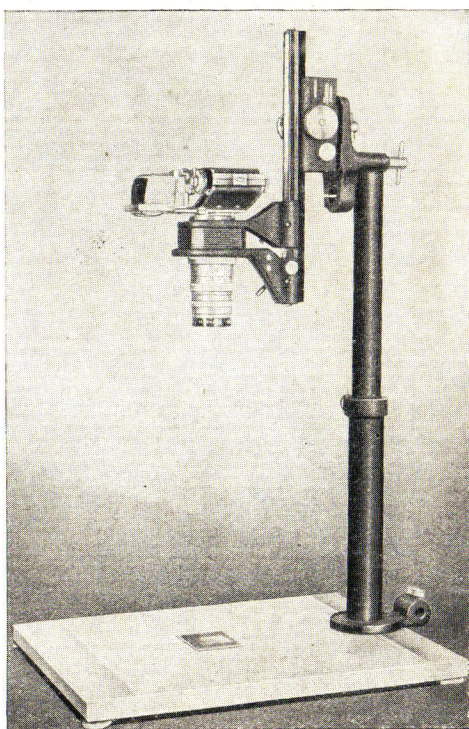

Fig. 59

the ground glass magnifier must be removed from the stereo-viewfinder by taking hold of it on the longitudinal sides and lifting it out. Then a special transparency-frame, which we deliver together with the "Stereoflex", is pushed on from outside making snap in the small pivots into the slits of the springs. The IHAGEE "Vielzweck" (Multi-combination) (Fig. 59), by its variety of combinations, opens further new possibilities in photographing. The "Vielzweck" enables you to obtain without difficulty reproductions with lower and upper light, miniature transparencies, difficult micro and macro pictures a. s. o. Please see for details in our booklet "Interesting Photos — easily obtainable" and in the directions for use "The Ihagee Vielzweck".

The Kolpofot is a part of the "Vielzweck". It is especially used in medical photography. For further details we refer to the special booklet "The Ihagee Kolpofot".

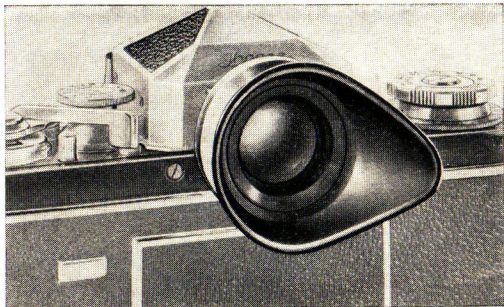

Fig. 60

Accessories

The Eyepiece (Fig. 60) for the Penta Prism and the Exposure Meter Insert facilitates focusing by eliminating stray side light from the finder. You can concentrate upon the reflex image and securely press the camera with the eyepiece against your face.

Weaksighted persons may insert a corrective glass corresponding to their spectacles into the mount of the eyepiece, thus focusing without any other visual help. For vertical exposures,

therefore, the view-finder eyepiece may be rotated by 90 degrees.

The Giant Release Button (Fig. 61) is screwed into the shutter knob (3 or 24c) enlarging its surface so that you may release more easily and securely, while wearing gloves with fingers numb from cold.

Color Filters. The purpose of filters in black-and-white photography is to render the colors of the subject to be photographed in the grey tone values corresponding to the impression upon the human eye, the film reacting on several colors differently from the human eye. The color of the filter appears brighter and the complementary color darker in the final positive, e. g. a yellow filter will produce tones of a lighter grey for the yellow areas and darker grey tones for the blue areas of the object, because to the human eye yellow appears to be the lightest and blue the darkest color. Thus the blue sky will appear darker in the picture and the white clouds will create a good contrast. Here



Fig. 61

the light conditions and the color sensitivity of the films play an important part. For more detailed information consult the technical literature! The filters are pushed on the lens front mount. Their mounts are shaped to accept also a push-on lens hood or a soft focus disc. The color filters are absorbing certain parts of the light, therefore, an increase of exposure time is necessary when using them:

Yellow filters, light and medium, require about 2—4 times the normal exposure time and

Yellow filters, dark	5 times the normal exposure time
Yellow-green filters, light	3 times the normal exposure time
Green filters, medium	4 times the normal exposure time
Blue filters, light	2 times the normal exposure time
Red filters, light	8 times the normal exposure time

The Lens Hood (Fig. 61) is far more important than generally believed. It protects the lens not only from frontal stray light when photographing against the sun, but also in every case against stray side light and glares, thus adding to the contrasts in the picture. The lens hood is pushed on the lens front mount or on the front ring of the filter mounts.

Soft-focus Discs are creating "atmosphere", and, therefore, in high esteem. The bright areas appear slightly over-emphasized towards the darker areas and help to get sunny atmosphere in the photo. The discs are also pushed on the lens front mount.

Polarizing Filters have the purpose to make disappear in the photos light reflections from glossy surfaces (glass, surfaces of liquids, paint, etc.). The light striking upon the glossy surfaces, which radiates in all directions, is, when reflecting, reduced in its oscillations and is swinging in one direction only. This polarized light can be eliminated by a Polarizing Filter, when photographing in a

certain angle to the reflecting surface (for glass about 35°). Push the Polarizing Filter on the lens mount and turn it, until you see that the reflexes disappear on the ground glass. Changing the camera position can either improve or make worse the troublesome reflexes. Photograph, therefore, only in an oblique angle to the subject. Experiment with the camera position and that of the Polarizing Filter, examining the ground glass and change them, until you get a maximum in elimination of the light reflexes. Because of its dim yellow coloring the Polarizing Filter requires twice the normal exposure time. Special literature will give you further detail. With metallic surfaces there is no light polarization and the filter gives no effect (e. g. with polished metallic surfaces, silvered mirrors etc.).

L. Careful handling of camera and lens

Camera with inserted lens or protective cover ought always to be kept, if possible, in the Everready Case or wrapped in a piece of dustproof cloth. All accessible parts should be kept clean and, if necessary, dusted off with a soft camel's hair-brush. The film track with film guides (32), film chambers (30 and 39), camera back (40) with film pressure plate (41) should always be cleaned. Occasionally the mirror of the EXAKTA VX must be dusted off delicately with a soft hairbrush.

The EXAKTA VX must be protected against dust, sand etc., as well as against moisture of any kind. Never touch with the fingers the glass surfaces of the lens, finder-hood, Penta Prism, Exposure Meter Insert, or Lens Magnifier, etc. If necessary, lenses and other glass surfaces may carefully be cleaned with a very soft piece of not ravelling out linen.

We strongly advise against tampering with the camera mechanism under any circumstances. Repairs should, whenever possible, be submitted to the expert mechanics in our works.

If you wish further informations, on demand special prints are at your disposal. Let us know, please, what you are especially interested in. Our Works will be pleased to place these booklets at your disposal, if desired.

Books that lead the way to good photos

Please ask your photo dealer or book store for:

"EXAKTA Kleinbild-Fotografie" by Werner Wurst. The authoritative, complete instruction book (Published by fotkinoverlag halle, Halle/Saale).

"EXAKTA Makro- und Mikro-Fotografie" by Georg Fiedler. An indispensable guide for two of the most important spheres of EXAKTA photography (Published by fotkinoverlag halle, Halle/Saale).

At present these two editions are only available in German.

"35 mm EXAKTA Handbook" by K. L. Allinson A. R. P. S. (Published by Fountain Press, London).

"35 mm Photography with an EXAKTA" by K. L. Allinson A. R. P. S. (Published by Fountain Press, London).

"EXAKTA Photography" by Jacob Deschin
(Published by Camera Craft Publishing Company, San Francisco 5, California).

"EXAKTA GUIDE" by W. D. Emmanuel (Published by Focal Press, London).

IHAGEE KAMERAWERK AKTIENGESELLSCHAFT · DRESDEN GERMANY



Printed in Germany