

WILSONWERKS ARCHIVES

This camera manual is for reference and historical purposes, all rights reserved.

This cover page is copyrighted material. This document may not be sold or distributed without the express consent of the publisher.

©2008 wilsonwerks Llc

H A S S E L B L A D[®]

Instruction Manual

 **500C/M**

  **500EL/M**

  **SWC/M**

Fig 12

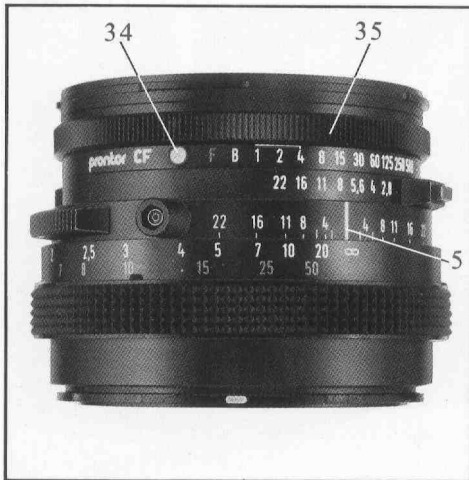

Shutter speeds: 1 to 1/500 s and B.
 At the B setting, the shutter remains open as long as the shutter release is depressed.
 Always use a cable release for long exposures.

NOTE Some films may display a loss of speed in very long exposures (reciprocity failure). Any exposure compensation necessary here is usually specified by the film manufacturer.

Warning signal

There is a red marking on the shutter speed scale opposite the 1, 1/2, and 1/4 s. This is to warn against possible exposure errors. The auxiliary shutter remains open as long as pressure is maintained on the shutter release. If the pressure is relaxed too soon, the auxiliary shutter will terminate the exposure prematurely. So make a habit of maintaining pressure on the shutter release until the leaf shutter has opened and closed fully.

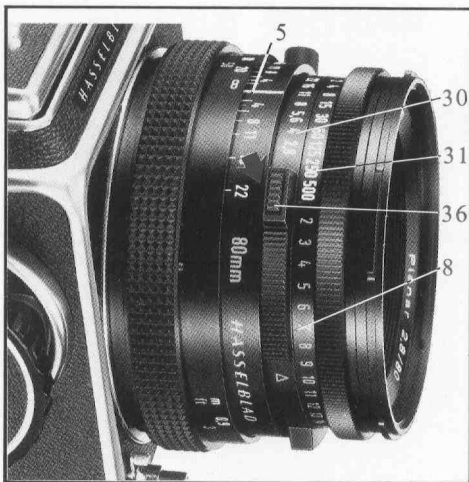

Exposure values (Fig. 13)

The aperture and shutter speed combination set opposite the central index (5) determines the exposure. Every combination of shutter speed/aperture has an equivalent exposure value (8).

Fig 13

The shutter speed ring (35) and the aperture ring (30) can be cross-coupled by pressing the cross-coupling button (7). When this button is depressed, the shutter speed/aperture combination can be changed without altering the exposure value (EV).

Should you, for example, wish to change from f/8 to f/11, the shutter speed will automatically switch to the corresponding shutter speed when the shutter speed and aperture rings are cross-coupled.

Focusing (Figs. 14—15)

The lens is focused with the focusing ring (4). The ring is turned until the subject is as sharp as possible on the focusing screen. “Rock” the ring back and forth around the point of apparent sharp focus a few times for maximum focusing accuracy.

The distance between the subject and the film plane is read off on the distance scale (10) opposite the central index (5). The distance in meters is shown in white numerals, and the distance in feet is in orange numerals.

Objects on the near or far side of the set distance can be sharp within certain limits. The limits for this field of sharp focus, i.e. depth of field, vary with the f/stop.

A small f/stop yields wide depth of field.

A large f/stop yields shallow depth of field.

The depth of field available at any given f/stop can be read off on the depth-of-field scale (6) on both sides of the central index (5). In the example shown here (Fig. 15), the lens is set at 7 m. Depth of field at f/11 will then range from 4 m to 20 m. (Also see “Depth-of-field Preview” on p. 7.)

Fig 14

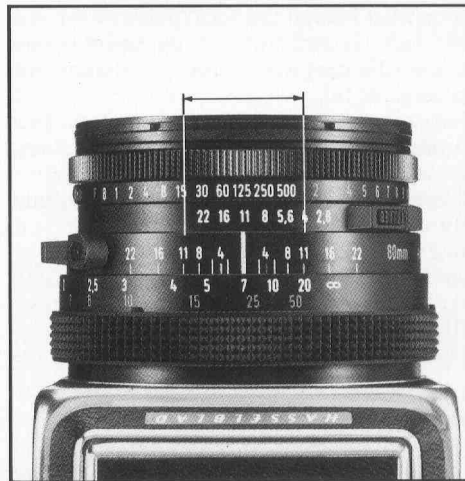
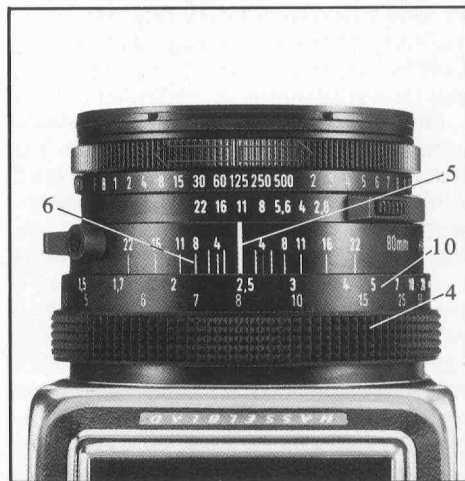

Fig 15

Fig 16

FLASH PHOTOGRAPHY (Fig. 16)

The 500C/M, 500EL/M, and SWC/M can be used for synchronized electronic and expendable flash at all shutter speeds from 1 to 1/500 s. Flash synchronization is made via the built-in leaf shutter's PC flash terminal (32). This terminal has a friction lock to keep the synch cord's PC contact more securely in place.

X synchronization

The shutter is fully synchronized for electronic flash (X) at all speeds (1 to 1/500 s). X synchronization triggers the shutter without delay to accommodate the brief duration of the light output from electronic flash units. Expendable flash is also possible with shutter speeds of 1/30 s or slower.

Infrared photography (Figs. 17—18)

Infrared (IR) rays (wavelengths longer than 800 nanometers) are refracted to a focal plane somewhat behind the focal plane of the visible light images formed on the focusing screen. To compensate for this discrepancy, proceed as follows:

Focus as usual on the focusing screen. Then rotate the focusing ring (4) until the distance set is opposite the red IR index (29).

Example: In Fig. 17 the lens is set at infinity for normal photography.

In Fig. 18 the setting distance has been adjusted for IR photography by setting the infinity symbol opposite the IR index (29). Infrared (IR) is the designation for wavelengths longer than 800 nm.

CHANGING LENSES (Figs. 19—20)**Lens removal**

Make sure the camera is cocked (white signal in the film advance indicator window 20) and

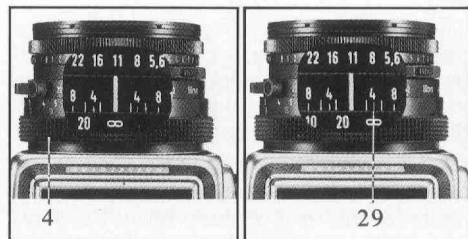

Figs 17—18

Fig 19

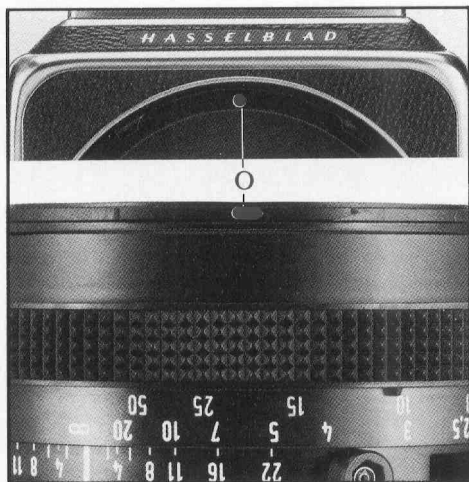

not pre-released. (“Pre-release”, p. 13.) Press the button (37) with your left index finger. Twist the lens *counter-clockwise* one tenth of a turn and remove it.

NOTE. The 500EL/M must **not** be set at RS or AS when lenses are changed.

Lens attachment

Ensure that the camera is cocked and not pre-released. Make also sure the lens is cocked. The slot (A) on the cocking shaft should point to the red index dot (B). (See “Shutter cocking” below for cocking unextended, detached lenses.)

Carefully insert the lens into the camera’s lens mount with the red marking on the lens barrel aligned with the red marking on the camera body. Twist the lens *clockwise* until it clicks into place.

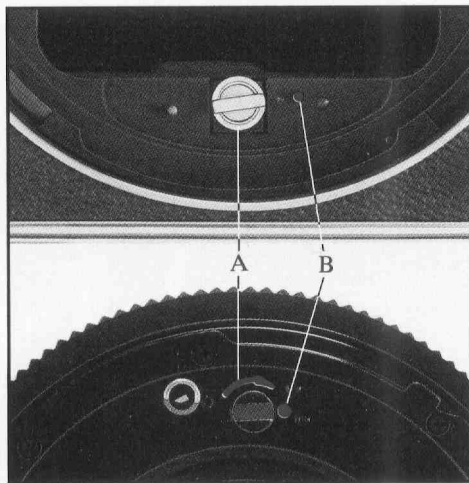

Shutter cocking

When the lens is attached to the camera, the shutter mechanism is automatically cocked each time the film is advanced. If the lens has been off the camera and the shutter inadvertently released, the shutter mechanism must be cocked before the lens is attached to the camera’s lens mount.

The shutter in a detached, unextended lens is cocked with a coin inserted into the slot (A) on the cocking shaft. Rotate the shaft *clockwise* slightly more than one turn until it stops. (Do *not* use a screwdriver or any other sharp object which could slip and damage the rear lens element.) When the lens is cocked, the slot (A) on the shaft will point to the red index dot (B). See Fig. 20.

Fig 20

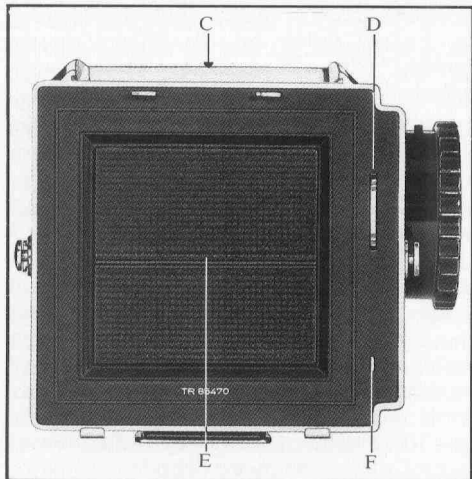
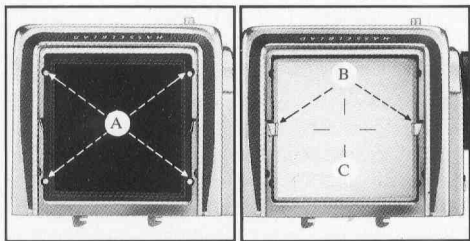

Fig 23

CAMERA BODY (Figs. 21—23)

Focusing screen

The focusing screen (C, Figs. 21—22) has 4 inscribed lines to facilitate horizontal and vertical alignment. Masks can be placed on top of the focusing screen when formats other than $2\frac{1}{4} \times 2\frac{1}{4}$ are used.

Changing the focusing screen

Remove the magazine and focusing hood. Slide the screen retaining catches (B) into the retracted position. Cup your hand over the focusing screen and turn the camera upside down. The focusing screen should then drop into your hand. If it fails to do so, remove the camera lens and gently tap the underside of the screen from inside the camera body. *Note.* The mirror must be in the down position. Insert the new focusing screen into the camera body. Make sure it rests firmly on all four screen supports (A). The retaining catches (B) automatically lock the screen in place as soon as a viewfinder is attached.

Camera body rear plate (Fig. 23)

The auxiliary shutter (E), which consists of two vertically moving blinds, can be seen through the rear opening of the camera body. The gear wheel (D) transfers the force applied to the film advance knob or crank to the magazine mechanism.

The pin (F) actuates the film advance indicator and automatically blocks the shutter release after the last frame is exposed.

Make sure (D) and (F) are kept clean and free from dirt and dust.

Exposure (Fig. 24)

Exposure takes place when the shutter release (14) is depressed.

Fig 24

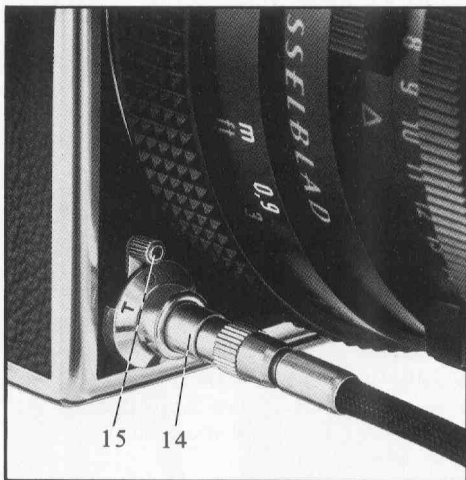

As a general rule for all exposure with the time exposure lock 15 at the O setting, the shutter release must be kept depressed until the between-the-lens shutter has opened and closed fully. This is especially important at shutter speeds from 1 s to 1/15 s.

If pressure on the release is relaxed too soon, the auxiliary shutter will terminate the exposure prematurely.

The cable release is screwed into the threaded socket in the shutter release.

Time exposure lock

The time exposure lock (15) has two settings: O (= disengaged) and T (= depressed shutter release locks in the depressed position until the lock is returned to the O setting).

The T setting can thus be used for time exposure when the shutter is set at B.

Film cannot be advanced until the lock is reset to O.

The setting cannot be used in operation with a cable release.

Pre-release (Fig. 25)

To reduce the low level of camera-induced shake to a minimum, the camera can be pre-released by pressing the pre-release button (17). This is what happens when the pre-release button is pressed: the mirror flaps up, the lens stops down to the preset working aperture, the auxiliary shutter opens, and the shutter closes (but remains cocked).

When the shutter release is pressed, only the operation of the between-the-lens shutter remains. Since the image on the focusing screen disappears in a pre-released camera, a sports viewfinder is a good way to keep track of moving subjects.

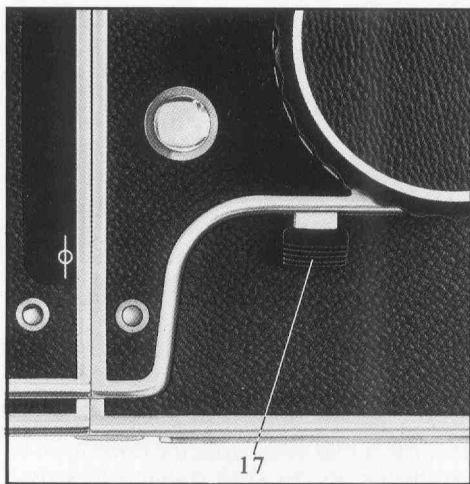
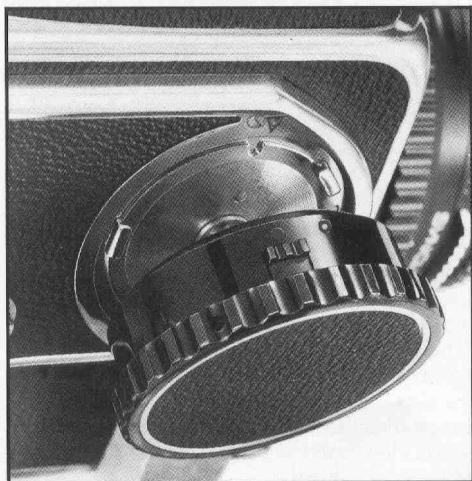
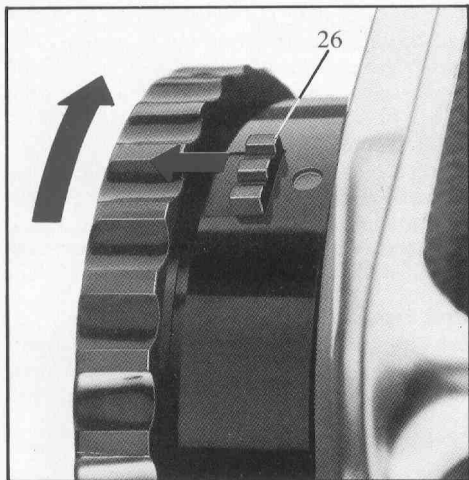

Fig 25

Fig 26



KNOB FOR FILM ADVANCE AND SHUTTER COCKING (Figs. 26—27)

An interchangeable knob for film advance and shutter cocking is standard equipment with each new camera. This knob can be replaced with a crank or a knob with a built-in exposure meter.

The knob has two functions:

- To advance the film.
- To set up the camera for a new exposure by actuating the mechanism which flips down the mirror, reopens the diaphragm, and cocks the shutter. Knob operation also actuates the film advance and shutter status indicator signals (see also p. 18).

Note The *shutter release* may refuse to budge for one of the following reasons:

- The last film frame has been exposed. This automatically blocks the shutter release. There will then be no number in the frame counter.
- The magazine slide has not been withdrawn.

The *knob may refuse to budge* for one of the following reasons:

- The time exposure lock is set at T.
- The auxiliary shutter was tripped with the release button but the shutter release was not subsequently pressed to trigger the leaf shutter (see p. 13).

Changing the knob

It is best to change the knob with the camera tensioned.

Knob removal: Push the spring-loaded release catch (26) away from the camera while bayoneting off the knob counter-clockwise.

Fig 28

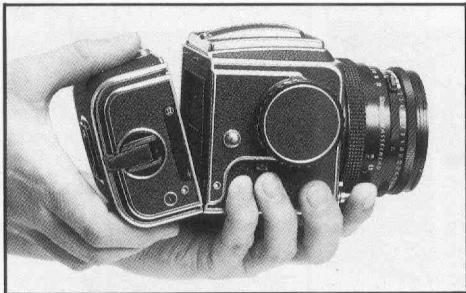

Knob attachment: Align the red circle on the knob with the red delta on the camera (see the picture) and bayonet the knob clockwise onto the mount.

FILM MAGAZINES

Changing the magazines (Figs. 28—29)

Make sure the indicator windows (19 and 20) are displaying white signals whenever magazines are changed. Insert the magazine slide (41). Slide the magazine release catch (28) to the right and swing down the magazine on the two lower support catches (40). The magazine slide protects the film from fogging if the magazine is detached from the camera. The magazine is attached to the camera as follows:

Hook the magazine onto the lower magazine support catches (40) and make sure the connection is secure. Then swing the top of the magazine up against the upper catches (A) while simultaneously pushing the magazine release catch (28) to the left. Release the catch and *then push it to the left to make sure the magazine is securely locked in place*. Remove the magazine slide.

NOTE A magazine can only be detached when the magazine slide is inserted. *No exposure can be made until the magazine slide is withdrawn from the attached magazine.*

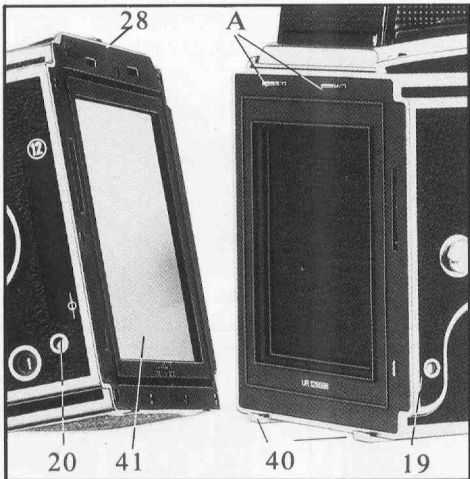

Fig 29

Loading the magazine

The magazine can be loaded on or off the camera. When the magazine is loaded off the camera, the magazine slide (41) must be inserted with the curl of its handle retainer facing the roll holder key (42).

Fig 30

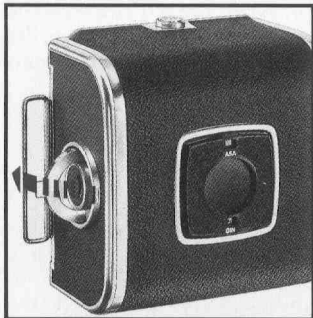

Fig 31

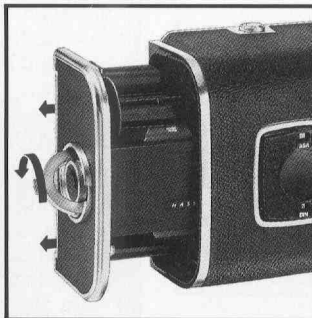

Fig 32

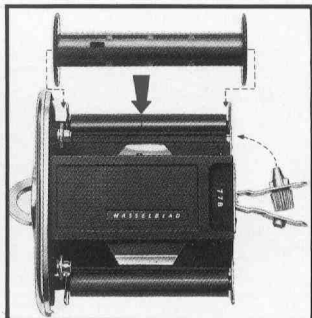

Fig 33

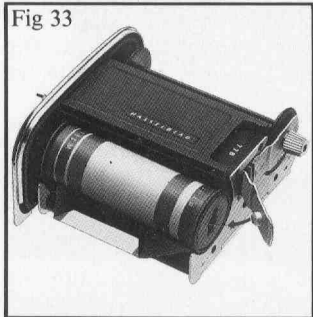

Fig 34

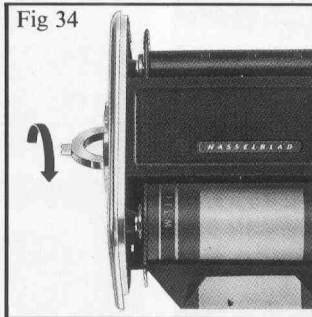

Fig 35

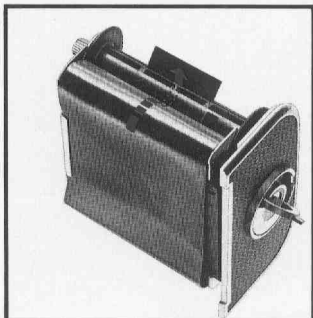
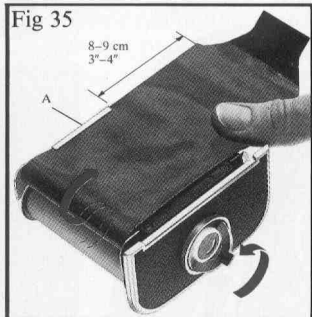

Fig 36

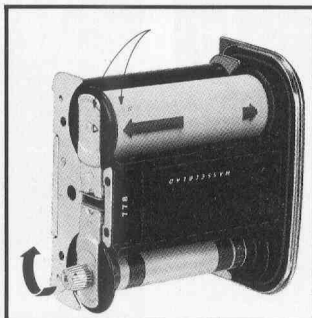

Fig 37

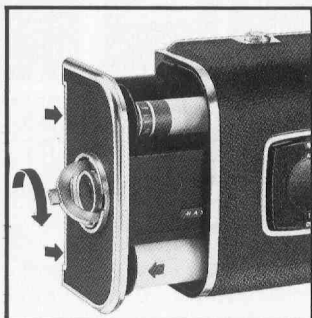

Fig 38

Fig. 30. Fold out the roll holder key.

Fig. 31. Turn the key counter-clockwise. Withdraw the roll holder completely.

Fig. 32. Flip both spool clips. Insert an empty take-up spool on the take-up side (with the knob clip) and flip down the clip. Twirl the spool to ensure that it is correctly seated.

Fig. 33. Insert a roll of film as shown in the illustration and flip down the clip. *Make sure the narrow, glued paper strip securing the paper backing is removed completely.*

Fig. 34. Turn the roll holder key on the side of the magazine *clockwise* so the film clamp (A, Fig. 35) opens.

Fig. 35. Pull out 3 to 3 1/2 inches of paper backing from the roll of film and guide it under the film clamp (A).

Fig. 36. Insert the tongue of the paper backing into a slit in the take-up spool.

Fig. 37. Turn the knurled knob *clockwise* until the arrow on the paper backing is opposite the delta on the spool clip. Then turn the roll holder key *counter-clockwise*.

Fig. 38. Slide the roll holder key into the magazine, jiggling it a little if it does not immediately click into place, and lock it by turning the key *clockwise*.

Fig. 39. Make sure the magazine slide is inserted (or that the magazine is attached to the camera). Fold out the film winding crank (23) and turn it clockwise until it stops (about 10 turns). Refold the crank. The number '1' will be displayed in the frame counter (21). The magazine is now loaded and ready for use.

Fig 39

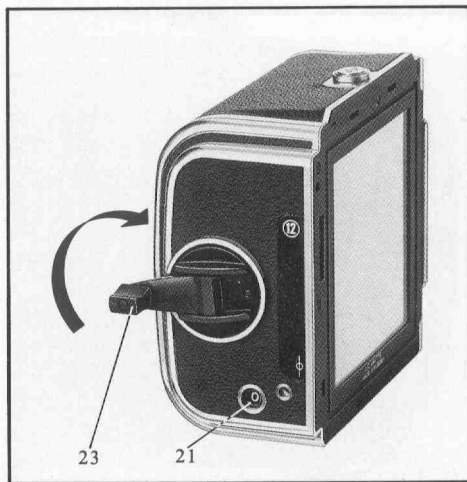

Note. The magazine can only be removed from the camera when the magazine slide is inserted. No exposure can be made when the magazine slide is inserted with the magazine on the camera.

People who buy their first Hasselblad seldom do so on the spur of the moment. Their decisions are usually preceded by careful study of the camera at one or more demonstrations. But a Hasselblad is literally packed with features to which no brief demonstration can do justice. So read this Instruction Manual carefully.

Previous owners of Hasselblad may choose only to leaf through the Manual. Not advisable, we feel. The Manual should be read from cover to cover. Even experienced photographers could miss a piece of information of potential importance. Our cameras are also modified from time to time. The Instruction Manual now covers the Hasselblad 500C/M, 500EL/M, and SWC/M cameras. All the basic concepts, such as film loading, attaching and detaching film magazines, lenses, viewfinders, focusing screens, etc. are described under the "Hasselblad 500C/M" heading. Features pertinent to the 500EL/M and SWC/M will be found under those headings. Hasselblad cameras are renown for their quality and precision, but, like any other precision instrument, they demand skill and know-how to yield the best results. So let us once again recommend a careful reading of this Instruction Manual. It will be worth the effort.

Fig 40

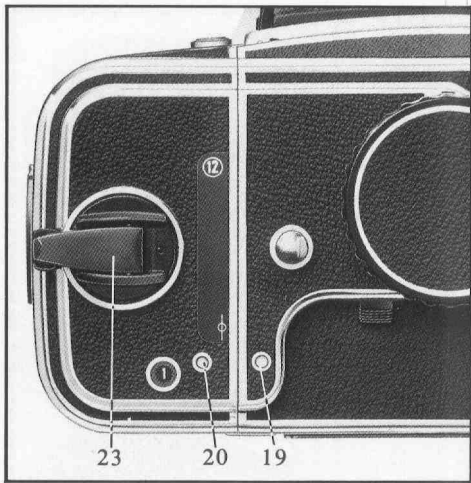

Indicator signals (Figs. 40—41)

Indicator signals (19 and 20) in the camera body and film magazine are actuated by film advance. The following signal combinations may be displayed in the indicator windows:

- A** Both windows white = Camera ready for exposure.
- B** Both windows red = Film not advanced and shutter not cocked. Advance the film. This operation automatically cocks the shutter.
- C** Magazine window red and camera body window white = Magazine was attached to a tensioned camera with the exposed frame unadvanced. Remove the magazine, trigger the camera, replace the magazine, and advance the film.
- D** Magazine window white and camera body window red = A magazine with exposed film frame advanced was attached to a triggered camera. Remove the magazine and tension the camera with the knob.

GOLDEN RULE: Make sure the signals in both windows display the same color when you attach a magazine to the camera.

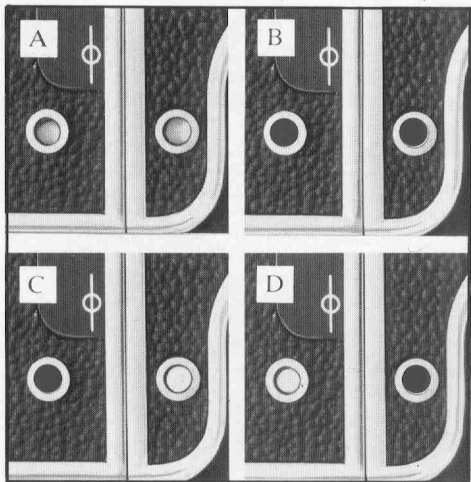

Fig 41

After the final exposure

The camera's release mechanism is automatically blocked when the final frame has been exposed. Fold out the magazine's film winding crank and wind the remaining film onto the take-up spool.

Miscellaneous (Figs. 42—43)

The magazine's film winding crank (23) is blocked only at frame '1'. So a partially exposed roll of film can be wound onto the take-up spool at any time.

The frame counter is automatically reset whenever the roll holder key is removed.

The center of the roll holder key (42) features a film consumption indicator (43) which is blank when the magazine has a full load on the supply spool. But the indicator gradually turns red as the film is exposed and advanced onto the take-up spool. A completely red indicator shows that the final frame has been exposed or that there is no film left in the magazine.

The film reminder (24) can be set at the ASA or DIN speed of the film used. You set this speed by flipping down the hinged clip and turning the serrated ring. There is a space behind the clip for a film box end.

Fig 42

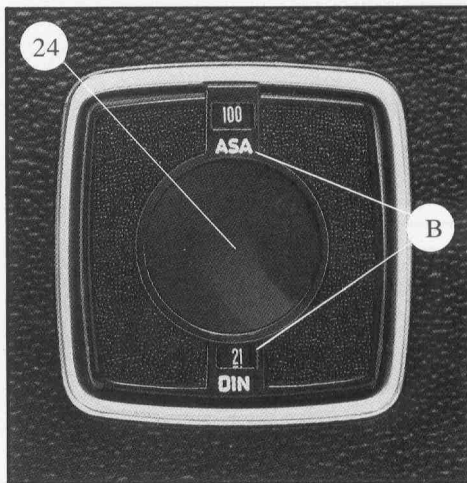
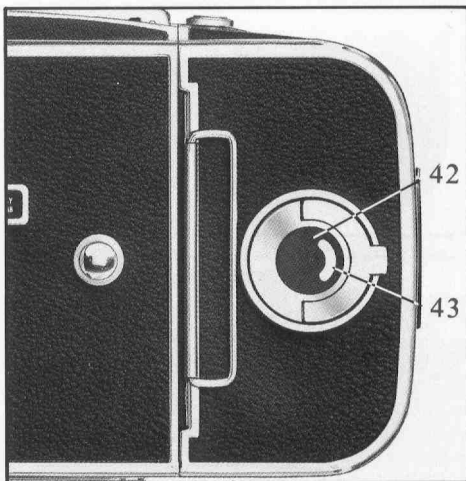
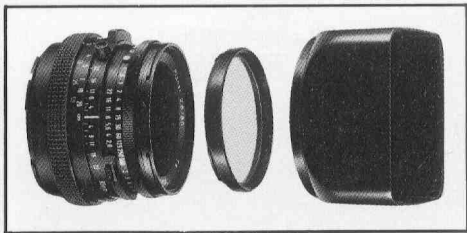

Fig 43

Fig 44



ACCESSORIES

Lens bayonet mounts

Hasselblad lenses with a 60mm Ø accessory mount have an internal bayonet mount for filters and Proxars and an external bayonet mount for lens shades and ringlight.

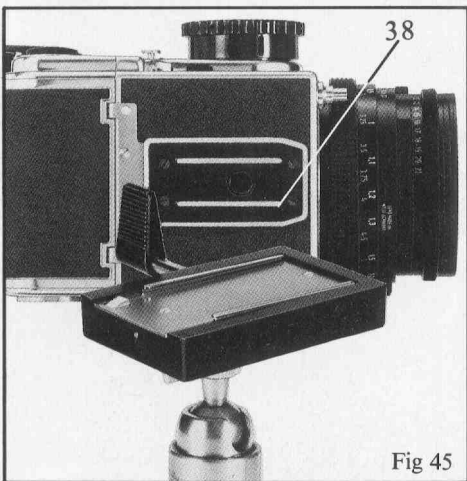

Tripod attachment (Fig. 45)

There is a tripod plate (38) on the base of the Hasselblad 500C/M and 500EL/M. It has a 1/4" and a 3/8" tripod socket.

Fig 45

STRAP LUGS

Strap attachment (Fig. 46)

Place the main body of the strap clip onto one of the camera's strap lugs (18). Press down on the tip of the clip and pull back so the strap lug slips into the opening at the tip of the clip. Repeat this procedure on the other side of the camera.

Strap removal

Lift the clip locking plate and slide the clip forward. The clip will then slide off the strap lug.

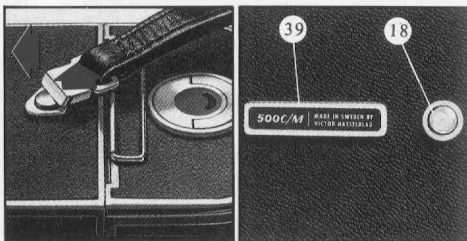

Accessory rail (Fig. 47)

The accessory rail (39) is used as the seat for e.g. the sports viewfinder, spirit level, or adjustable flash.

Figs 46—47

500EL/M

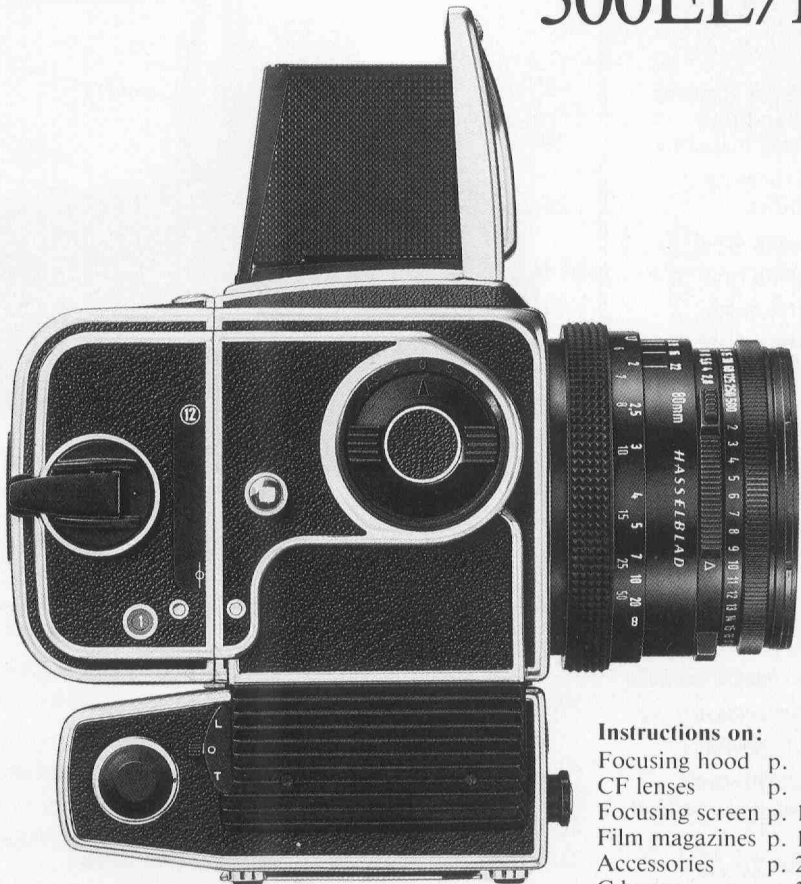

Instructions on:

- Focusing hood p. 6
- CF lenses p. 7—10
- Focusing screen p. 12
- Film magazines p. 15—19
- Accessories p. 20
- C lenses p. 35—40

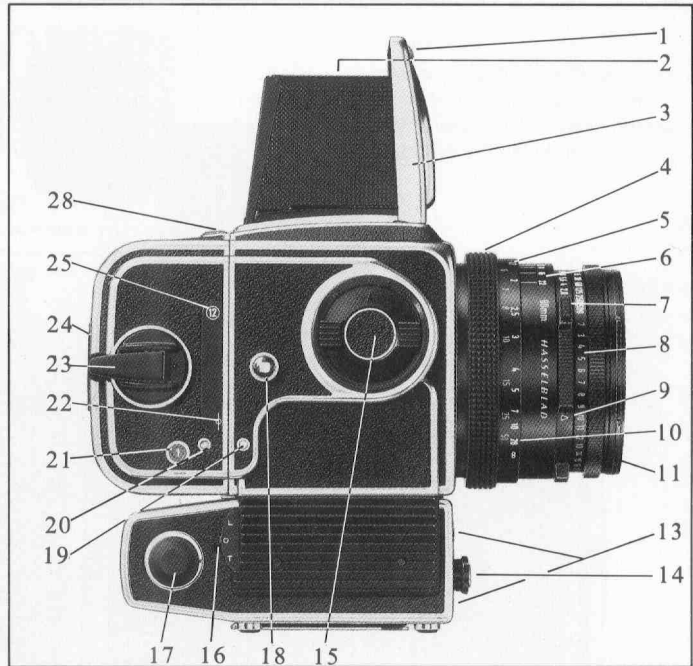

1. Catch for focusing hood and fine-focusing magnifier
2. Fine-focusing magnifier
3. Focusing hood
4. Focusing ring
5. Central index
6. Depth-of-field scale
7. Button for cross-coupling of shutter speed and aperture rings
8. Exposure value scale
9. Exposure value index
10. Distance scale (feet and meters)
11. External and internal accessory mounts
13. Front release sockets
14. Shutter release
15. Mode selector
16. Time exposure, locking and charging lever
17. Side socket for camera release and battery charging

18. Strap lug
19. Shutter status indicator
20. Film advance indicator
21. Film counter
22. Film plane indicator
23. Folding film winding crank

24. Film reminder
25. Magazine designation
26. Battery compartment cover
27. Battery compartment cover catch
28. Magazine release catch

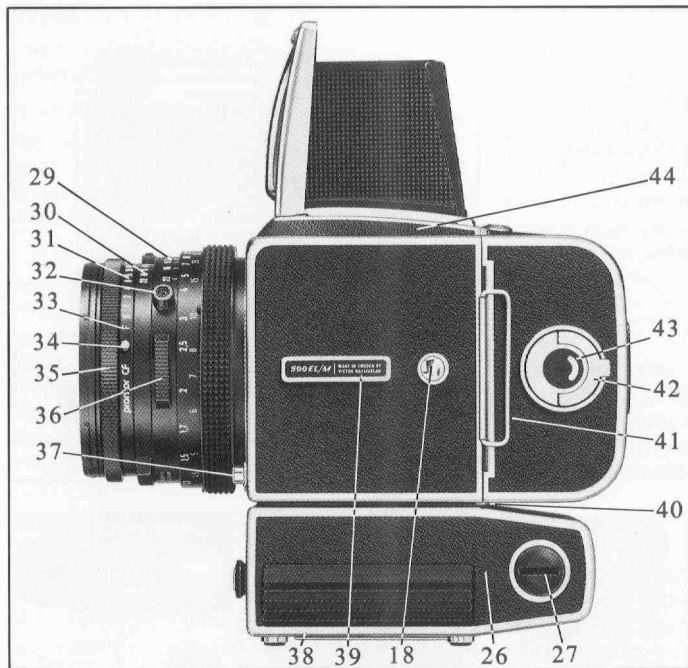

- | | | |
|-----------------------------------------|-----------------------------------------|--------------------------------|
| 29. Index for infrared compensation | 34. Detent button for F setting | 39. Accessory rail |
| 30. Aperture ring with aperture scale | 35. Shutter speed ring | 40. Magazine support catches |
| 31. Shutter speed scale | 36. Depth-of-field preview tab | 41. Magazine slide |
| 32. PC flash terminal | 37. Lens lock release button | 42. Roll holder key |
| 33. F setting (used only with 2000FC/M) | 38. Tripod plate and 3/8" tripod socket | 43. Film consumption indicator |
| | | 44. Focusing screen |

Fig 48

CAMERA BODY (Fig. 48)

The camera body contains the mechanical and electrical components for camera operation. The lower section (B) contains compartments for the batteries, fuse, and motor. The upper section (A) contains the mode selector, focusing screen, mirror, and auxiliary shutter. The camera body is equipped with fixtures for viewfinders, lenses, and film magazines plus sockets for camera release and battery rechargers.

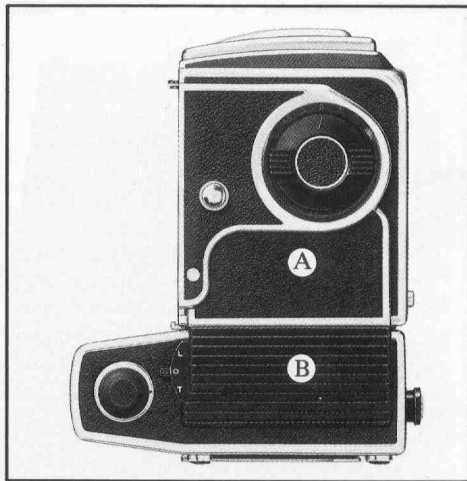
**BATTERIES** (Figs. 49—50)

The camera is operated by a battery-powered motor (C). Rechargeable DEAC 5/600 DKZ batteries (nickel-cadmium accumulators) are used. The battery compartment (B) holds two batteries. Each battery is good for about 1,000 exposures.

Battery insertion

Use a coin in the slot to turn the battery compartment cover catch (27)—the slot should then be vertical. The battery compartment cover (26) then unlocks at the rear end and can be removed.

Insert each battery with the '+' end first. The battery compartment cannot be closed if a battery has been inserted incorrectly.

The camera cannot be released, nor the batteries charged until the battery compartment cover has been closed.

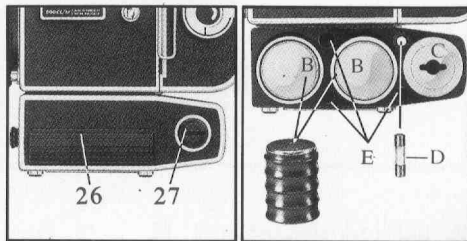

Figs 49—50

Fuse

A 1.6 A medium slow-blow fuse (5 × 20 mm) must be used in the fuse receptacle (D). Always have a spare fuse on hand. Spare fuses can be stored in the three receptacles (E).

Fig 51

MODE SELECTOR (Fig. 51)

The mode dial has five settings governing the camera release mode.

O = Normal mode. When the shutter has been triggered and pressure on the shutter release relaxed, the film is advanced, the between-the-lens shutter is cocked and the mirror is returned to the focusing position.

S = Pre-release. Certain mechanical functions are pre-released in this mode, leaving only operation of the between-the-lens shutter when the release button is pressed. This reduces camera-induced shake even further and reduces to a minimum the time elapsing from the moment the shutter release is pressed until the shutter actually operates. The mode selector automatically returns to the O mode after each cycle.

RS = Pre-release repeat. Operation is the same as in the S mode but the camera remains in the S mode after shutter release.

A = Automatic. The camera makes continuous exposures as long as the triggering impulse is supplied and unexposed film remains in the magazine. The sequential exposures in this mode are at a rate of about 1 frame/s. The A setting cannot be used with shutter speeds slower than 1/15 s.

AS = Automatic pre-release. The same operation as in the A mode, but the camera remains in the pre-release mode after every exposure sequence.

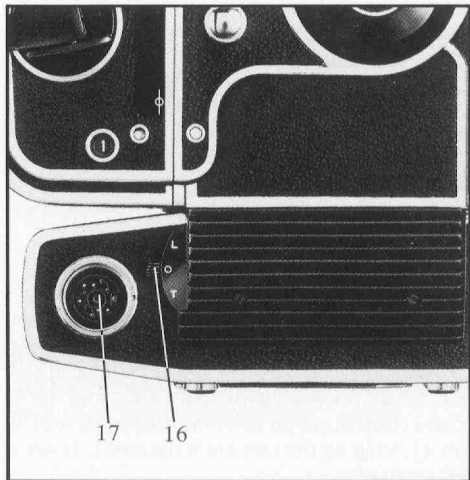
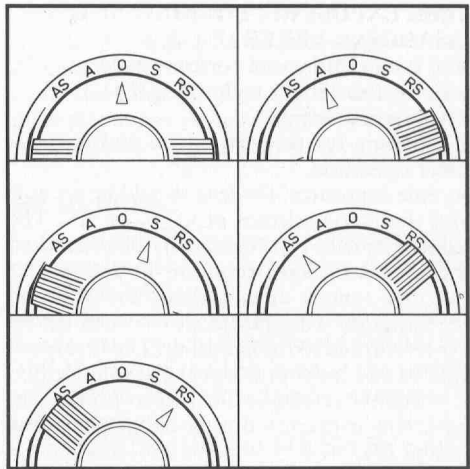

Fig 52

Fig 53

TIME EXPOSURE, LOCKING AND CHARGING LEVER (Fig. 52)

The lever (16) is used for time exposure (T), locking and battery recharging (L).

O = Normal setting.

T = Setting for time exposures and for self-timer operation.

In time exposures, the lens should be set at B and the mode selector at O, S, or RS. The camera shutter is mechanically opened when the lever is shifted from O to T. The shutter can then remain open without any drain on the batteries. The shutter closes when the lever is returned to the O setting. The film is advanced and the shutter cocked automatically. L = Shutter release is blocked to prevent inadvertent triggering during battery charging (see p. 27).

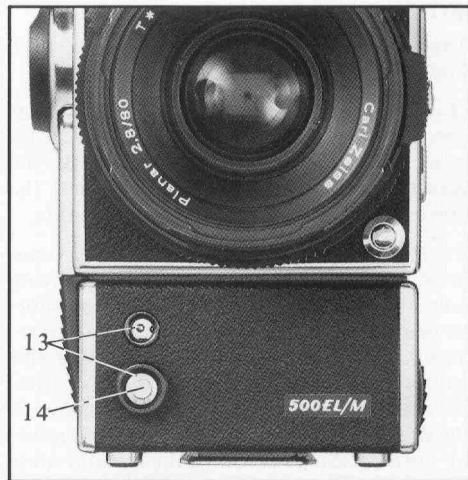

Double exposure

Proceed as follows when multiple exposures are desired on the same frame:

Press the shutter release and keep it depressed. Move the time exposure, locking and charging lever (16) to the L setting. Insert the magazine slide and remove the magazine. Return the lever (16) to the O setting. Replace the magazine. Make an exposure in the normal way. Repeat this cycle if additional exposures are desired on the same frame.

Side socket for camera release and battery charging

The camera's side socket for camera release and battery charging (17) is a standard 5-pole DIN socket. It is used for shutter triggering by means of release cords (SK, LK, and DK), radio control, or an intervalometer, as well as for recharging the camera's batteries. It has a protective cover.

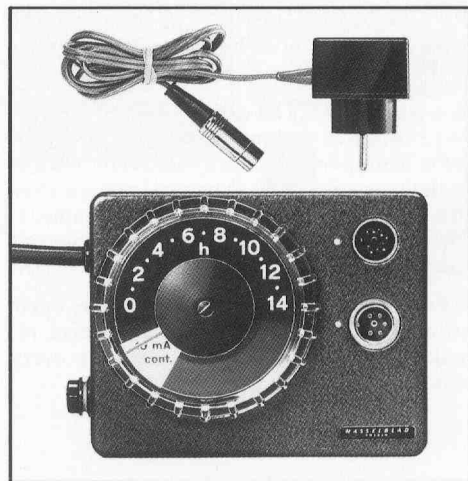

Fig 54

ALTERNATIVE RELEASE METHODS

The camera can be triggered in different ways, e.g. with a release cord, intervalometer, by radio control, etc.

The general rule for all release methods is that the button which triggers the release impulse to the camera must be kept depressed until the between-the-lens shutter has opened and closed completely. This is especially important at shutter speeds from 1 to 1/15 s. If the shutter speed is set at 1 s, for example, and pressure on the release button is relaxed before the between-the-lens shutter has had time to close, the auxiliary shutter will terminate the exposure prematurely.

Release sockets (Fig. 53)

The front of the camera features two identical sockets (13) for attachment of a release cord or a release button. The release button or shutter release (14) is normally in the lower socket but can be removed by simply pulling it out.

FK type cords are suitable release cords.

Release cords

A tripod should be used when operating the camera at slow shutter speeds. Camera release by release cord is then suitable. Release cords in lengths from 1 ft to 20 ft are connected to the front sockets (13). Release cords from 100 ft to 600 ft and cords for connection of a recharge unit are connected to the side socket (17). When cords longer than 100 ft are used, an amplifier should be put between camera socket and cord.

General

The 500EL/M can also be released by closing the electric circuit between pins 1 and 3 (see the circuit diagram in p. 28). External resistance should not exceed 6 ohms if triggering is to be reliable.

RECHARGING

Recharge unit I is standard equipment with each new camera and is used for recharging the camera's batteries.

Move the lever (16) to the L or O position. Connect the recharge unit to the side socket (17). Make sure the unit is set at the correct voltage (110 or 220 VAC) and connect it to a wall outlet.

Recharging time is about 14 hours for a fully discharged battery and 28 hours if two batteries are recharged simultaneously. Batteries should not be overcharged.

Change or recharge a battery as soon as the camera recycling time becomes noticeably prolonged. If a battery becomes so exhausted that the camera stops working or stops in the middle of a cycle, move the lever (16) to L and connect the recharge unit.

NOTE! The L setting must be used if the camera has not recycled fully. If the camera has recycled, either the L or the O setting can be used for battery recharging.

Battery charger option

Recharge unit III with a built-in timer is available as an optional extra.

Fig 1

HOW TO PREPARE YOUR 500C/M AND 500EL/M FOR OPERATION

Front protective cover

Unscrew the protective cover (with bayonet mount) in the direction of the arrow.



Attaching the lens

First make sure that the camera is advanced and not in the pre-released mode.

Make sure the lens mechanism is cocked. The slot (A) on the head of the cocking shaft should point to the adjacent red index dot (B). See also p. 11 for the procedure of cocking a released, detached lens.

Align the red delta at the rear of the lens with the red dot (O) on the camera lens mount. Rotate the lens **clockwise** until it stops and locks into place with a **click**.

Fig 2

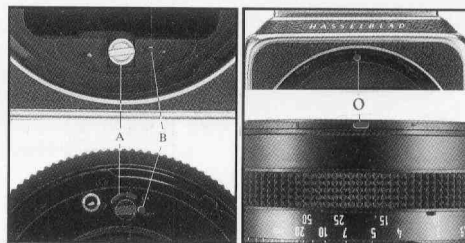
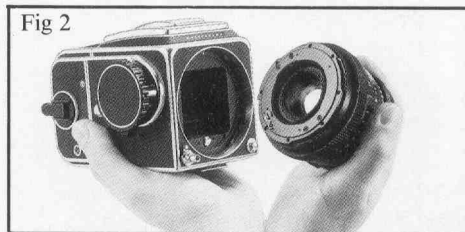
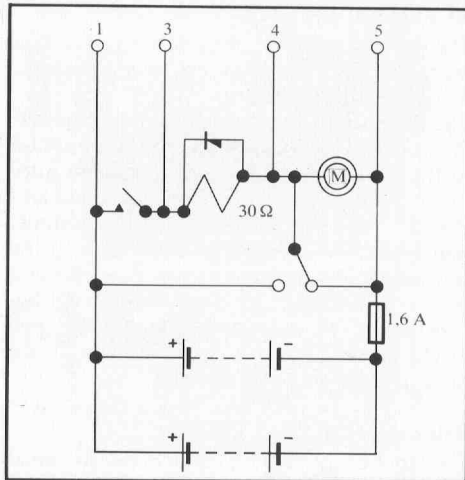

Fig 3

CIRCUIT DIAGRAM

Voltage: 6V
Batteries: One or two DEAC 5/600
DKZ without soldering
tabs or battery terminals.
Fuse: 1.6 A medium slow-blow
(5 × 20 mm).
Socket: Preh 8-6404
Exposure current
(pins 1 and 3): 0.2 A

Fig 55



SWC/M

Instructions on:

CF lenses p. 7—10
Film magazines p. 15—19
C lenses p. 35—40

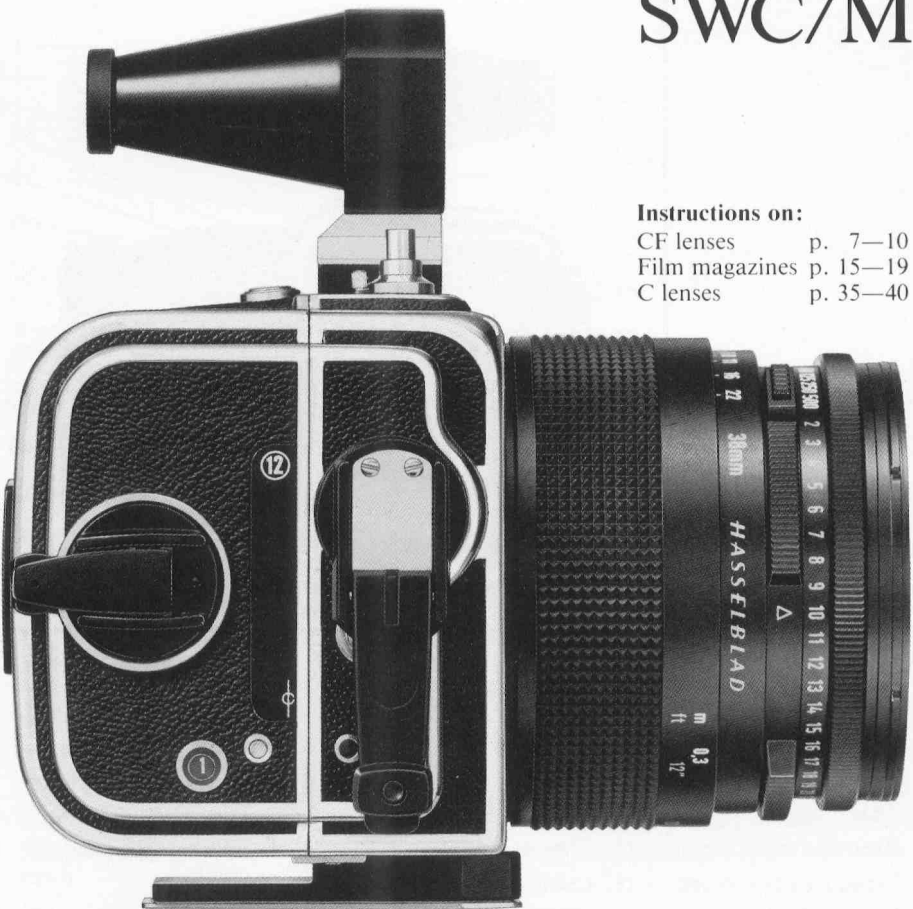

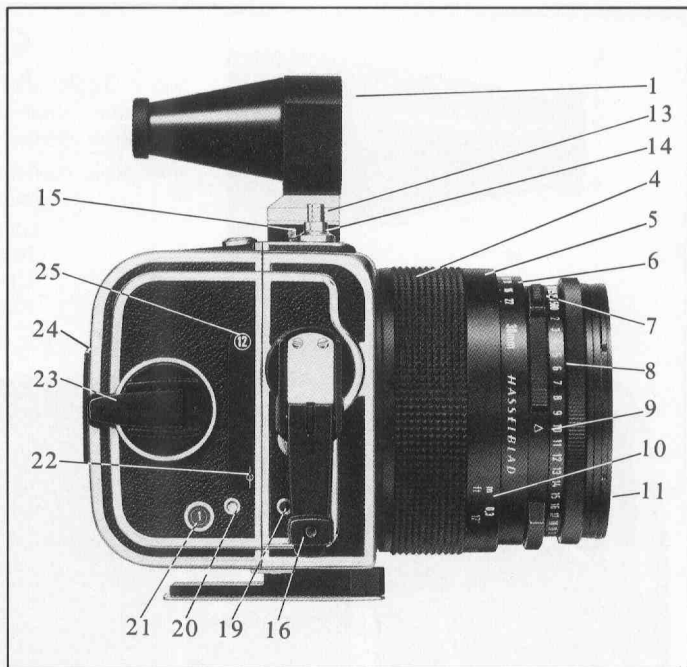

- | | | |
|------------------------------------------------------------------|------------------------------------------------|--------------------------------|
| 1. Viewfinder | 11. External and internal accessory mounts | 18. Strap lug |
| 2. Protective rubber ring | 13. Threaded cable release socket | 19. Shutter status indicator |
| 4. Focusing ring | 14. Shutter release | 21. Film counter |
| 5. Central index | 15. Time exposure lock | 22. Film plane indicator |
| 6. Depth-of-field scale | 16. Crank for film advance and shutter cocking | 23. Folding film winding crank |
| 7. Button for cross-coupling of shutter speed and aperture rings | | 24. Film reminder |
| 8. Exposure value scale | | 25. Magazine designation |
| 9. Exposure value index | | |
| 10. Distance scale (feet and meters) | | |

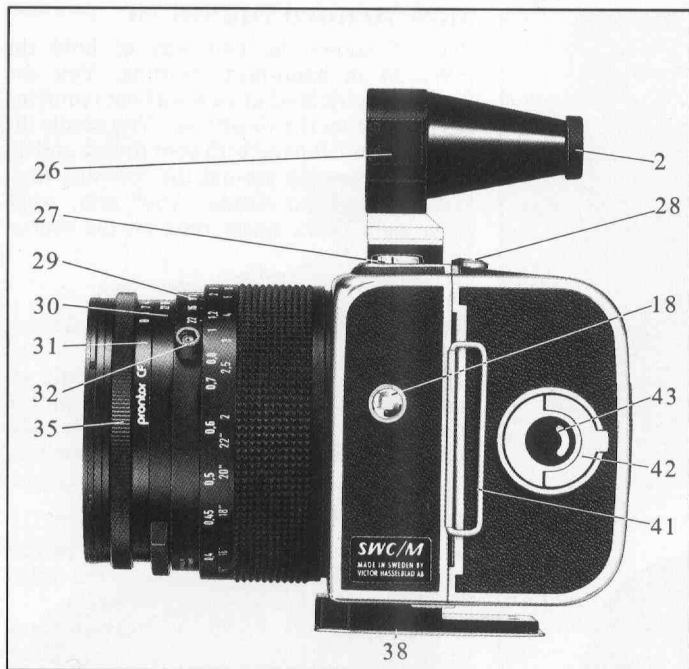

- | | | |
|--------------------------------------|---------------------------------------|--------------------------------|
| 26. Reflector prism for spirit level | 30. Aperture ring with aperture scale | 40. Magazine support catches |
| 27. Spirit level | 31. Shutter speed scale | 41. Magazine slide |
| 28. Magazine release catch | 32. PC flash terminal | 42. Roll holder key |
| 29. Index for infrared compensation | 35. Shutter speed ring | 43. Film consumption indicator |
| | 38. Tripod plate | |

Fig 56



HOW TO HOLD THE SWC/M

Fig. 56 shows the best way to hold the SWC/M in hand-held shooting. You can keep the spirit level in view without removing your eye from the viewfinder. You cradle the lens in your left hand with your thumb and index finger curled around the focusing ring. Your right hand steadies your grip, while your right index finger rests on the shutter release.

MAIN CAMERA COMPONENTS

The Hasselblad Super Wide C/M consists of three main components:

The camera body with its permanently attached Biogon lens, the detachable optical viewfinder, and the interchangeable film magazine which also fits the other Hasselblad cameras.

VIEWFINDERS (Figs. 57—58)

The optical viewfinder (1) shows the picture area and a simultaneous view—via the reflecting prism (26)—of the spirit level (27).

The reflector makes it possible to keep a constant check on the spirit level during hand-held use of the camera.

The viewfinder has the same angle of view as the lens, but it takes in a slightly larger field because of its location on top of and behind the lens. The difference is as follows:

- | | |
|----------------------|-------------------------------------|
| Top of the field: | 6 in. larger. |
| Bottom of the field: | Viewfinder and lens field coincide. |
| Sides of the field: | 3 in. wider on each side. |

This is the case irrespective of the lens-to-subject distance.

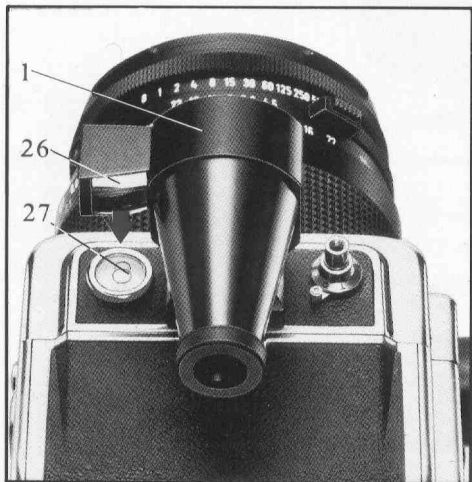

Fig 57

Fig 58

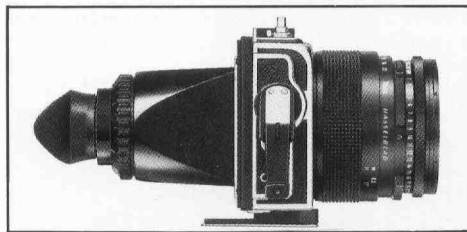
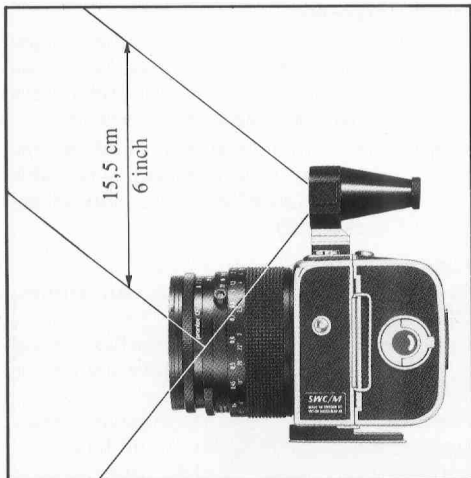

Fig 59

So decide on the desired framing and camera angle and use the spirit level (27) to level the camera. In hand-held work, you should concentrate on keeping the camera level at the moment of exposure.

This is extremely important, since the ultra wide-angle lens demands careful alignment for accurate rendition of vertical lines in the subject. Leveling the camera with the aid of the spirit level is even easier if a tripod is used.

Focusing screen adapter (Fig. 59)

The focusing screen adapter is used when an exact check on depth of field and image composition is necessary. It is attached to the camera in place of the film magazine. The focusing screen adapter has a seat to permit attachment of a magnifying hood, prism viewfinder, or focusing hood.

Image checks on focusing screen

Set the shutter at B.

Set the lens at the maximum aperture.

Set the time exposure lock (15) at T.

Open the shutter by depressing the shutter release.

When the checks have been completed, return the time exposure catch to O, thereby closing the shutter. Cock the shutter with the film advance crank. Remove the focusing screen adapter and reattach your film magazine. Then make your exposure in the ordinary way.

Cleaning the Biogon lens

The optical design of the Biogon lens has resulted in unsurpassed performance for a wide-angle lens. However, the short distance between the rear lens element and the film means that performance can easily be impaired by even a trace of dust. So when cleaning your lens, pay particular attention to the rear lens element.

Fig 60

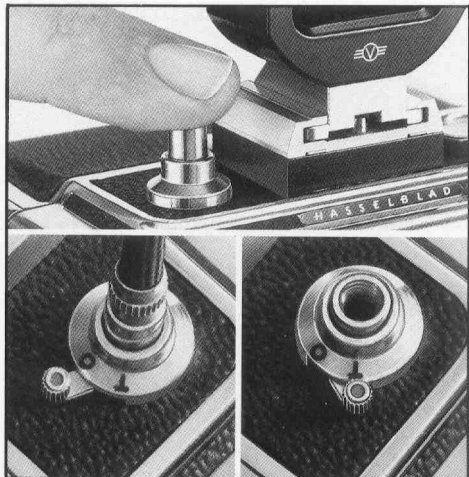

Making exposures

The Hasselblad SWC/M has a shutter release button on top of the camera body. When you make an exposure, press the shutter release (14) smoothly, exerting steady pressure.

Note! The shutter must be cocked and the magazine slide removed. The cable release is attached to the cable release socket (13).

Time exposure lock

The time exposure lock (15) has two settings: O = Normal setting

T = Release button locked after being pressed. Remains depressed until the lock is returned to the O setting.

The T setting is used for time exposures when the lens is set at B. The film cannot be advanced with the crank (16) until the time exposure lock is returned to the O setting.

This blocking function will not operate when a cable release is attached.

Magazines for Polaroid film (Fig. 61)

When a magazine for Polaroid film is used with the SWC/M, the film advance crank is unable to make a complete turn. Proceed as follows in this case:

Attach a magazine for Polaroid film.

Make an exposure.

Move the crank up and down with a pumping movement (2 1/4 times) until it stops.

Note! The magazine ~~100~~⁸⁰ for Polaroid film must **never** be used with the SWC/M.

Tripod attachment

There is a tripod plate (38) on the base of the Hasselblad SWC/M. The plate has two tripod sockets (1/4" and 3/8").

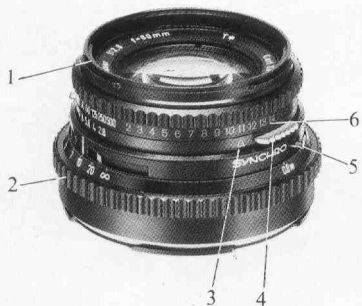

Fig 61

C lenses

Instructions on:
Changing lenses p. 11





1. External and internal accessory mounts
2. Focusing ring
3. Exposure value index
4. Cross-coupling release
5. Depth-of-field preview catch
6. Exposure value scale
7. Catch for synchronization and self-timer selector (8)
8. Synchronization and self-timer selector



9. PC flash terminal
10. Distance scale
11. Automatic depth-of-field indicators
12. Central index
13. Aperture scale
14. Shutter speed ring and shutter speed scale
15. Grip ring for setting shutter speed, aperture, and exposure value

Fig 62

C LENSES

C lenses (this designation does not appear on the lenses) can be used with the 500C, 500C/M, 500EL, 500EL/M, 2000FC, and 2000FC/M (see also the Instruction Manual for the 2000FC/M).

They all feature a built-in Synchro-Compur leaf shutter, an automatic diaphragm, an exposure value scale, automatic depth-of-field indicators, M and X flash synchronization at all speeds, and a self-timer V. The C lenses attach to the camera via a bayonet mount.

Diaphragm (Fig. 62)

The aperture ring (13) and shutter speed ring (14) are cross-coupled. Both rings are operated with the grip ring (15). For independent setting of the aperture or shutter speed, press the cross-coupling release (4) to the rear and rotate the ring until the desired value is opposite the central index (12). The lens is normally focused wide open. The diaphragm automatically closes down to the working f/stop at the moment of exposure. Press the depth-of-field preview catch (5) to check out the available depth of field. This will stop the lens down to the working aperture. The diaphragm is reopened to the maximum aperture by turning the aperture ring (13) to the maximum aperture or tripping the shutter (with a detached film magazine) and winding the camera.

Shutter speeds (Figs 63—64)

The shutter speed ring (14) has three different scales with white (black on chrome finish lenses), green, and red numerals. Only the white (black) numerals and B can be set opposite the central index (12).

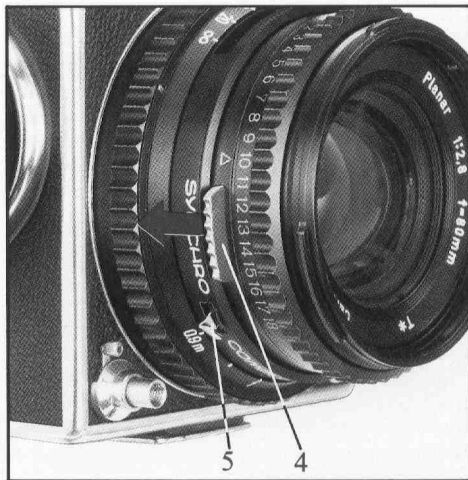

Fig 4



Rear protective cover

Press the catch in the direction of the arrow and tip the cover backwards. Lift it off the lower magazine support catches.

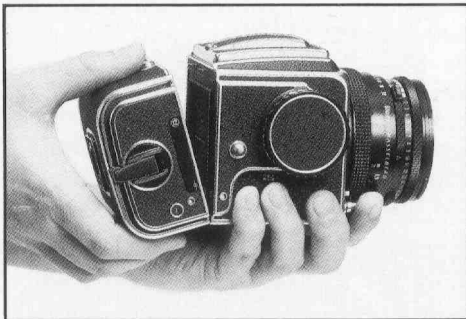

Fig 5

Attaching a magazine

Hook the magazine onto the camera's lower magazine support catches (40) and make sure the attachment is secure. Then pivot the upper part of the magazine against the upper catches while sliding the magazine release catch (28) to the right. Release the catch and *make sure the magazine is locked in place by sliding the catch to the left.*

Shutter speeds: 1 s to 1/500 s and B. The B setting enables you to make exposures lasting more than one second. The shutter remains open as long as the shutter release remains depressed. Use a cable release at slow shutter speeds. The numerals '1' to '500' designate the speeds 1, 1/2, 1/4, 1/8, 1/15 s, etc.

The green scale is used for calculating exposures when lighting is so weak that a 1 s exposure is inadequate.

Exposure values are set on the red scale.

Exposure values (Fig. 63)

The aperture/shutter speed combination opposite the central index (12) determines the exposure. Each such combination has an equivalent exposure value (6).

The exposure value is determined with an exposure meter, such as the Hasselblad knob with exposure meter.

The value obtained is set opposite the index (3). Once the correct exposure value is set this way, a correct exposure will be obtained with any shutter speed/aperture combination set opposite the central index (12) using the grip ring (15). (Not applicable to B.)

Time exposure

C lenses have a green shutter speed scale to facilitate the calculation of correct exposures lasting longer than 1 s. The green figures on the scale designate **full seconds** from 4 s to 125 s (B stands for 2 seconds).

Example: The exposure meter indicates an exposure value of 7. This would be equivalent to an exposure of e.g. f/2.8 at 1/15 s. If f/22 is preferred for more depth of field, turn the grip ring (15) for shutter speeds/apertures to B. Read off the number on the green scale opposite 22, i.e. 4 (seconds) in this case. Re-



tain the B setting. Uncouple the diaphragm ring so that 22 is opposite the central index. Then make a 4 s exposure with the aid of a cable release.

Note! Some films may display a loss of sensitivity (reciprocity failure) at very long exposures. Any exposure compensation necessary will be indicated on the data sheet supplied with the film.

Focusing (Fig. 64)

The distance is set with the focusing ring (2). The ring is turned until the subject is as sharp as possible on the focusing screen. "Rock" the ring back and forth past the point of apparent sharpest focus before you stop. This will make it easier to ensure that the lens is focused properly. The distance from the subject to the film plane is read off on the distance scale (10) opposite the central index (12).

Fig 64

Objects on the near or far side of the set distance may also be in focus within certain limits. The limits for this area of sharp focus, depth of field, vary with the aperture. A small aperture yields wide depth of field, a large aperture yields shallow depth of field.

The depth of field available at any given aperture is automatically designated on the distance scale by the depth-of-field indicators. There is greater depth of field on the far side of the distance set than on the near side.

Depth-of-field indicators (Fig. 65)

The automatic depth-of-field indicators (11) greatly simplify focusing. They consist of two moving pointers. The distance between the pointers changes when the aperture setting is changed. The largest aperture provides shallow depth of field, so the distance between the pointers is narrow at this f/stop. A small aperture, such as f/22, yields wide depth of field, and the distance between pointers is then wide. See Fig. 65. The thin ring shows the position of the depth-of-field indicators at the largest aperture (f/2.8). The thick ring shows the position at the smallest aperture (f/22).

Some practical tips

Proceed as follows if you have predetermined a desired depth of field. Focus on the closest part of the subject and read off the distance on the distance scale. Do the same thing for the most distant part of the subject. Set the depth-of-field indicators so they point to the two distances obtained. In sports photography, for example, you can preset the depth-of-field indicators to the desired depth of field. All the action within these preset distance limits will then be in sharp focus.

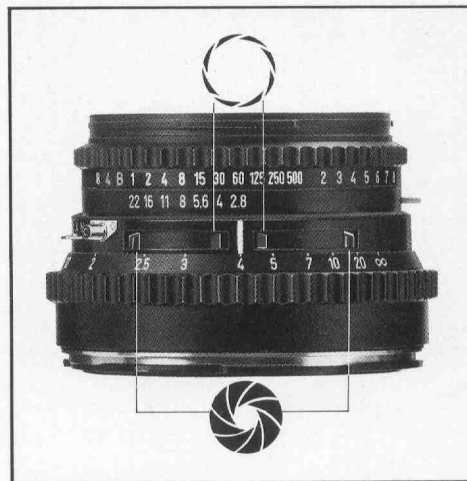
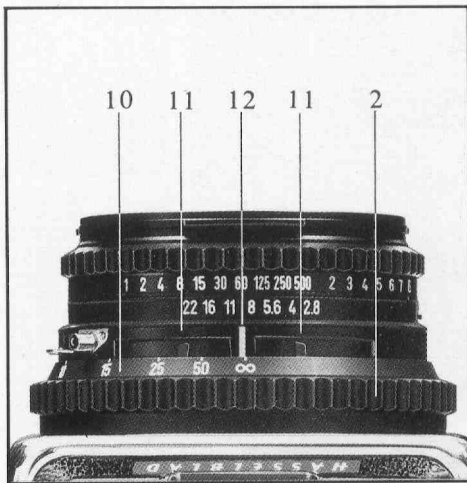
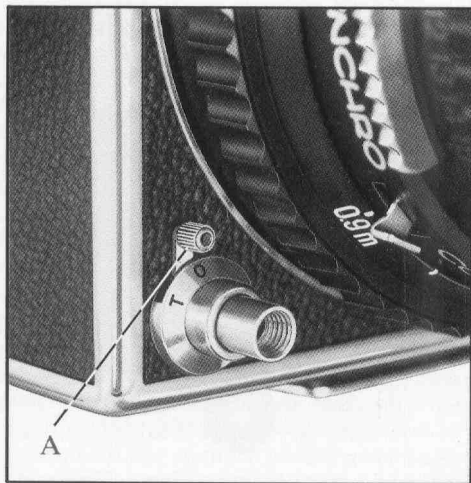
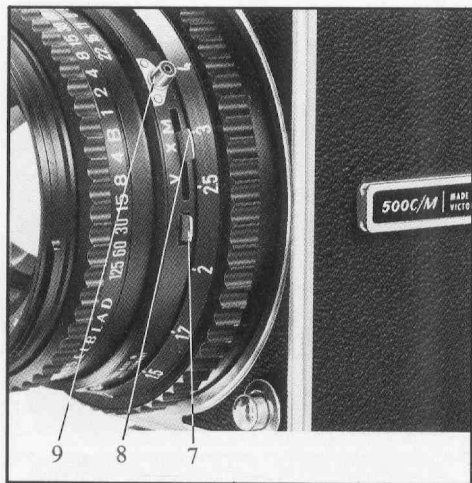

Fig 65



FLASH PHOTOGRAPHY (Fig. 66)

The 500C/M, 500EL/M, and SWC/M can be used with electronic or expendable flash at all shutter speeds, i.e. from 1 to 1/500 s. Flash synchronization is made via the leaf shutters PC flash terminal. The selector for V, X, and M has a detent to prevent inadvertent movement of the catch (7).

Flash synchronization

The leaf shutters have X and M synchronization. The catch (7) is pressed forward, thereby freeing the synchronization and self-timer selector for setting at X or M. The flash connecting cord is connected to the standard PC terminal (9) on the lens.

X synchronization

The X setting is for electronic flash at all shutter speeds and expendable flash at speeds of 1/30 s or longer. The shutter is triggered without delay because of the brief duration of electronic flash output.

M synchronization

The M setting is used for all M class flash-bulbs/cubes at all shutter speeds. The shutter is delayed slightly since expendable flash takes time to build up to its maximum output.

Self-timer (V) (Figs. 66—67)

The self-timer operates at shutter speeds from 1 to 1/500 s. X synchronization is then automatic. Press catch (7) forward. Then cock the self-timer mechanism by moving the selector (8) to the V position. Set the time exposure lock (A) at T. The self-timer begins working as soon as the shutter release is pressed. The shutter then trips 8-10 s later. After the exposure, return the time exposure lock to O before the camera is recocked and the film is advanced.

SERVICE AND MAINTENANCE

Cameras and lenses subjected to heavy-duty professional use should be serviced regularly at an authorized Hasselblad service center. We recommend regular checkups to ensure maximum operating reliability.

Lubricants can dry up in cameras put aside for any length of time, e.g. six months or more. The high-precision mechanism in a leaf shutter, for example, could then malfunction. So a stored camera should be taken out from time to time and operated at each shutter speed a few times.

It is especially important to "loosen up" the shutter before working with the camera for the first time after a long period of disuse. First operate the camera without a magazine attached. Look through the camera body and lens to ensure that all the shutter speeds are working.

WARRANTY

The Hasselblad cameras are made in Göteborg, Sweden. They are products of the highest quality and are therefore warranted against defects in workmanship and materials for a period of twelve months from the date of purchase.

Please fill in and mail the enclosed registration card as soon as you take delivery of your new camera. Please print clearly.

The warranty certificate will be sent to you as soon as we receive your registration card. We will also put you on our mailing list and send you our printed matter as it is published.

Damage caused to the camera by improper use is not covered by the terms of the warranty. Shipping costs to and from the nearest Hasselblad authorized service center will be defrayed by the camera owner.

VICTOR HASSELBLAD AKTIEBOLAG

Box 220, S-401 23 Göteborg, Sweden

500C/M

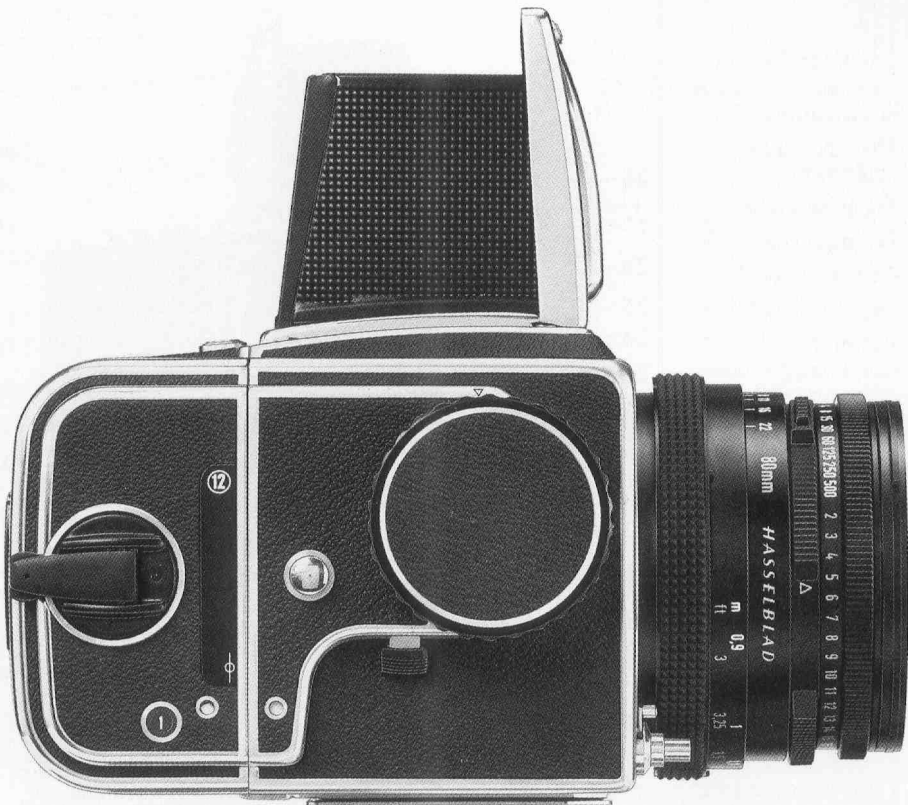
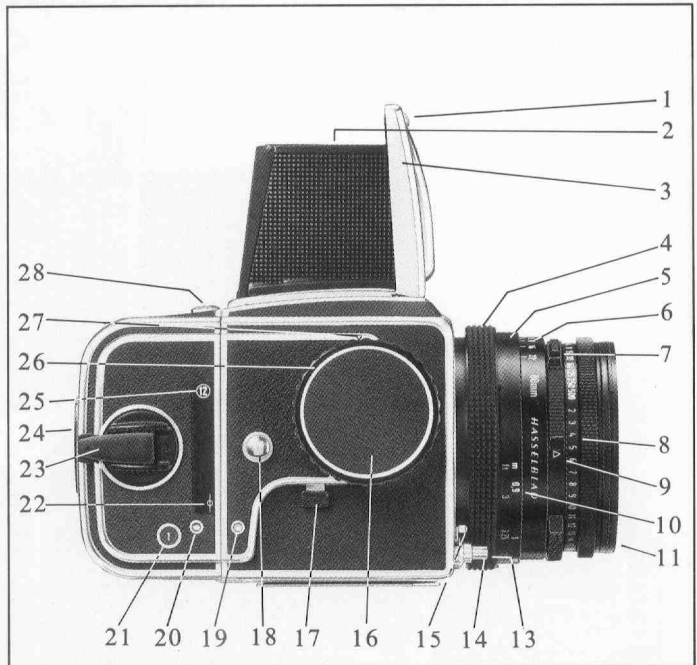

Fig 6



1. Catch for focusing hood and fine-focusing magnifier
2. Fine-focusing magnifier
3. Focusing hood
4. Focusing ring
5. Central index
6. Depth-of-field scale
7. Button for cross-coupling of shutter speed and aperture rings
8. Exposure value scale
9. Exposure value index
10. Distance scale (feet and meters)
11. External and internal accessory mounts
13. Threaded cable release socket
14. Shutter release
15. Time exposure lock
16. Knob for film advance and shutter cocking

17. Pre-release button
18. Strap lug (one on each side)
19. Shutter status indicator
20. Film advance indicator
21. Frame counter
22. Film plane indicator

23. Folding film winding crank
24. Film reminder
25. Magazine designation
26. Knob release catch
27. Knob positioning index
28. Magazine release catch

Fig 7

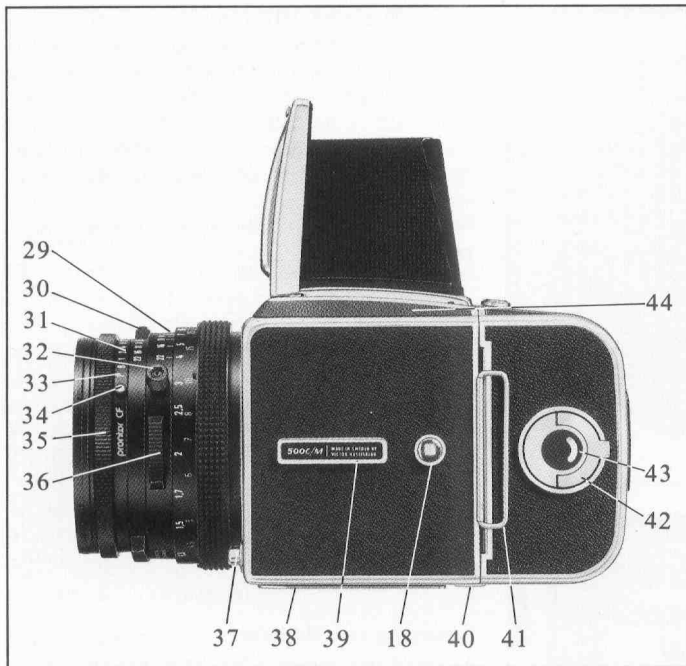

29. Index for infrared compensation

30. Aperture ring with aperture scale

31. Shutter speed scale

32. PC flash terminal

33. F setting (used only with 2000FC/M)

34. Detent button for F setting

35. Shutter speed ring

36. Depth-of-field preview tab

37. Lens lock release button

38. Tripod plate and 3/8" tripod socket

39. Accessory rail

40. Magazine support catches

41. Magazine slide

42. Roll holder key

43. Film consumption indicator

44. Focusing screen

Fig 8



LEFT-HAND GRIP (Fig. 8)

Fig. 8 shows the best way to hold a Hasselblad 500C/M when taking pictures. Hold the camera cradled in your *left* hand with your *left* index finger on the release button. This leaves your right hand free to carry out other operations, such as film winding, focusing, etc.

Always make it a habit to use the left-hand grip.

FOCUSING HOOD (Figs. 9—10)

The focusing hood (3) automatically opens when the catch (1) is slid to the right. For critical checks on image sharpness, use the fine-focus magnifier which pops up when the catch (1) is again slid to the right. Flip the hood down until it clicks into place before closing the focusing hood. Then fold the hood's side leaves down over the focusing screen, followed by the rear leaf and finally the front leaf.

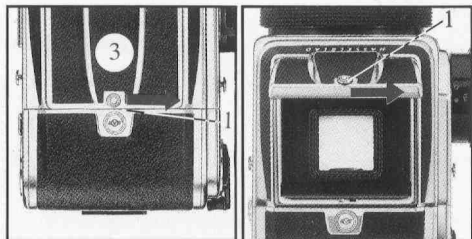

Figs 9—10

Changing viewfinders:

1. Remove the film magazine (see p. 15).
2. Slide the viewfinder back out of the grooves.
3. Slide the new viewfinder into the grooves and press it firmly forward.
4. Replace the film magazine.

CF LENSES

The 80mm f/2.8 Planar is the standard Hasselblad lens. Lenses developed for the 500C/M and 500EL/M are referred to as CF and C lenses (for C lenses, see p. 35). CF lenses can also be used on the 2000FC and 2000FC/M and can then operate with their

Fig 11

built-in leaf shutter or with that shutter disconnected (exposure is made with the camera's focal plane shutter).

The CF lenses feature built-in Prontor CF leaf shutters with an automatic diaphragm, exposure value scale and X synchronization. These lenses attach to the camera via a bayonet mount.

Diaphragm (Fig. 11)

CF lenses have an automatic diaphragm that stops down to the working aperture immediately prior to exposure.

Depth-of-field preview:

Press down on the top part of the depth-of-field preview tab (36). Use your left thumb. The lens will then stop down to the preset working aperture.

Upward pressure on the tab will reopen the diaphragm to the maximum aperture.

(After film advance, the diaphragm is always reopened to the maximum aperture unless the tab is depressed.)

Shutter speeds (Fig. 12)

Shutter speeds are set on the shutter speed ring (35) opposite the index (5). The shutter speed ring has two scales, an F setting and a green detent button. The white scale shows the shutter speeds and the orange scale the exposure values.

The green F setting is only used when the lens is attached to a 2000FC or a 2000FC/M camera (the F setting disconnects the optic's built-in leaf shutter. See the Instruction Manual for the 2000FC/M.) The F setting can be made only after depressing the green detent button (34).

