

# WILSONWERKS ARCHIVES

This camera manual is for reference and historical purposes, all rights reserved.

This cover page is copyrighted material. This document may not be sold or distributed without the express consent of the publisher.

©2008 wilsonwerks Llc

35<sup>c</sup>

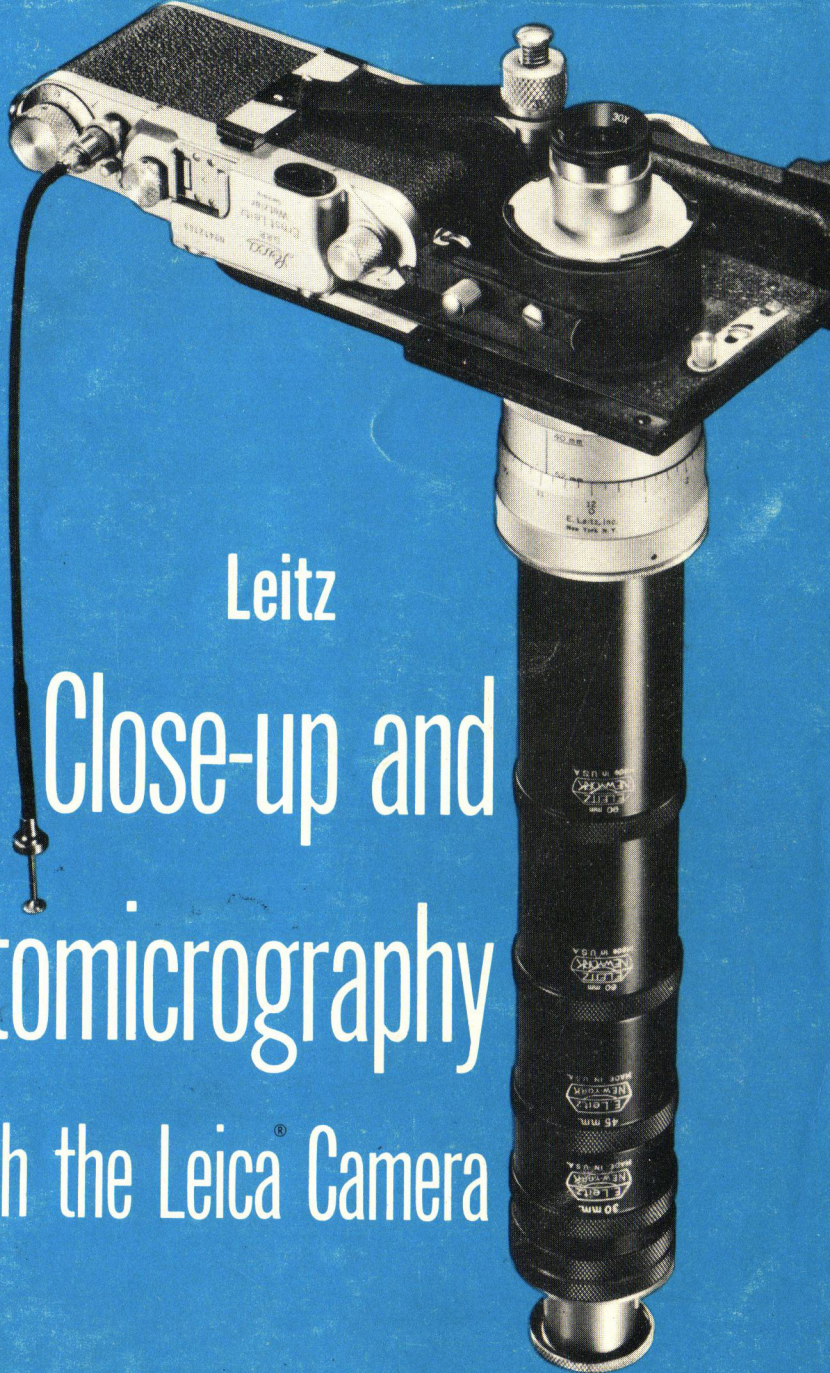

Leitz

Close-up and  
Photomicrography  
with the Leica<sup>®</sup> Camera



**Close-up and  
Photomicrography  
with the Leica Camera**

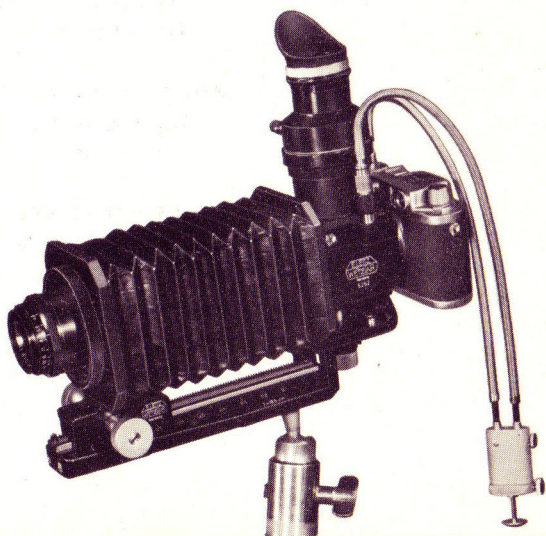
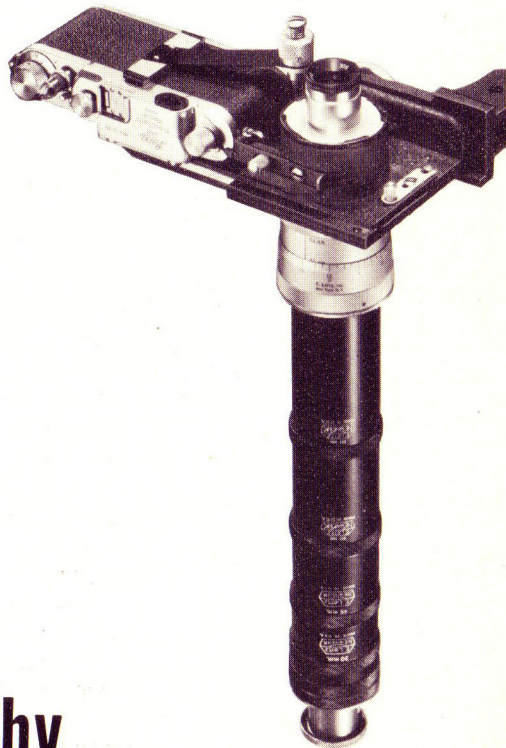

# CONTENTS

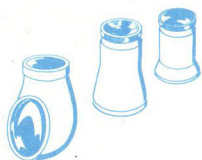
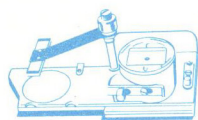

<b>LEITZ COPYING EQUIPMENT</b> .....	6
<b>THE FOCASLIDE</b> .....	8
How it works .....	8
How to Mount the Focaslides.....	8
Setting up the Focaslides.....	10
<b>MAGNIFIERS FOR THE FOCASLIDE</b> .....	12
5x Magnifier with focusing sleeve.....	12
5x Wide-Field Magnifier .....	12
5x Wide-Field Angular (90°) Magnifier.....	12
4x Wide-Field Image Reversing Magnifier.....	12
30x Magnifier with focusing sleeve.....	13
Operating the locking lever.....	14
<b>HOW TO USE THE FOCASLIDE</b> .....	15
Lens choice .....	15
<b>EXTENSION TUBES</b> .....	16
<b>ADJUSTABLE MICROMETER EXTENSION TUBE</b> .....	16
Directions for alignment.....	17
Formula for calculating exposure.....	19
Lens adapters .....	20
<b>TABLE I — DATA ON FOCASLIDE EXPOSURES</b> .....	
Exposure calculation .....	24
Film choice .....	24
<b>INTERMEDIATE FOCUSING MOUNT</b> .....	26
Compensating ring .....	27
<b>SHORT-DISTANCE FOCUSING DEVICE</b> .....	28
<b>NEAR-FOCUSING DEVICE</b> .....	28





**TABLE II — COMPARISON CHART OF CLOSEUP ACCESSORIES DEVICES** ..... 30

**AUXILIARY REPRODUCTION DEVICES** ..... 30

**TABLE III — AREAS COVERED BY LEICA LENSES** ..... 31

**PHOTOMICROGRAPHY WITH THE FOCASLIDE** ..... 32

**THE MICRO-IBSO ATTACHMENT** ..... 34

**BELLOWS FOCUSING DEVICE** ..... 37

    With Mirror Reflex Housing ..... 37

    With special Sliding Focusing Attachment ..... 38

    Focusing ..... 39

    Used with the Hektor 135mm. Lens ..... 39

    Used with the Elmar 50mm. Lens ..... 39

    Exposure ..... 39

**TABLE IV — BELLOWS DEVICE EXPOSURE DATA** ..... 40

**BELLOWS SUNSHADE** ..... 40

**MICROFILMING WITH REPROVIT II** ..... 43

    Baseboard ..... 43

    Upright supports ..... 43

    Clamping arm ..... 43

    Copying head ..... 43

    Focusing ..... 44

    Lights ..... 45

    Easel ..... 45

    Field Use ..... 47

    Sliding Copying Attachment ..... 47

    Automatic diaphragm stop ..... 47

    Exposure ..... 47

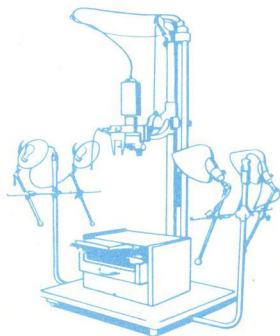

## LEITZ COPYING EQUIPMENT

Within recent years there has been wider recognition of the fact that the miniature camera, which has already revolutionized the technique of amateur and pictorial photography, has as much to contribute to the progress of the working methods of professional photographers of all kinds and those practicing photography for scientific purposes. Many amateurs who took up the Leica merely as a means of pleasure and recreation made the discovery that it could also be an instrument of real value, by virtue of the series of practical accessories which we have developed for it in the course of time.

Copying does not limit itself to the reproduction of written matter and drawings, but includes the making of records of objects of the most varied kind and size, to produce negatives for printing or enlarging in the usual way or for projecting in the form of positives. Projection is the best way of presenting, to the public, printed reproductions or lectures with lantern slides, of objects which are not directly accessible or are unavailable for viewing.

Miniature photography represents an important advance in this line of work. Its advantage lies in its ability not merely to produce large numbers of negatives and positives at a minimum cost, but also to store and carry them with the least possible inconvenience and to project them with small, light and inexpensive projection equipment.

The medical expert, lecturing to a conference on his work and having his evidence in the form of large X-ray films, which are too valuable to be taken along and indeed too large to be projected without special apparatus being available, reproduces these results by means of his Leica. An ample number of positives can be taken anywhere, and easily projected onto a screen to a size of 8 x 12 ft.

The historian or the handwriting expert may desire to show parts of an old volume which he may neither remove from the archives where it lies nor expose it to the strong illumination of powerful light-sources; he can, however, copy the folio page by page without having to take it away, examine either the negatives or a positive strip at his ease at home with our desk viewer, prepare enlargements to any desired size with the Focomat Enlarger and thus utilize them with the most successful results in journals or monographs. Large numbers of scientific specialists have already convinced themselves of the value of this method. The very low cost of the negative material eliminates any question of excessive expense.

The botanist and the zoologist, the mineralogist and petrographer, the archeologist, the entomologist and many other scientists have similarly come to appreciate the advantages of miniature photography.



Our copying devices are not only suitable for scientific use but are employed with great success for commercial and industrial purposes. The value of the photographic process in duplicating and, particularly, in the wide field of advertising is evident, and these methods are achieving great importance, in fact, they have already achieved it.

**Definitions:** The terms *photomicrography*, *macrophotography*, and *microphotography* are often inter-used, misinterpreted, or simply not understood. These are the accepted definitions:

**MICROPHOTOGRAPHY:** The reproduction of any object on a very minute scale. The grainless structure of a collodion transparency lends itself particularly well to this work.

**MACROPHOTOGRAPHY:** Photographs of small objects reproduced at natural or larger than natural size, made without a microscope.

**PHOTOMICROGRAPHY:** The photography of minute objects by the use of a microscope in conjunction with a camera.

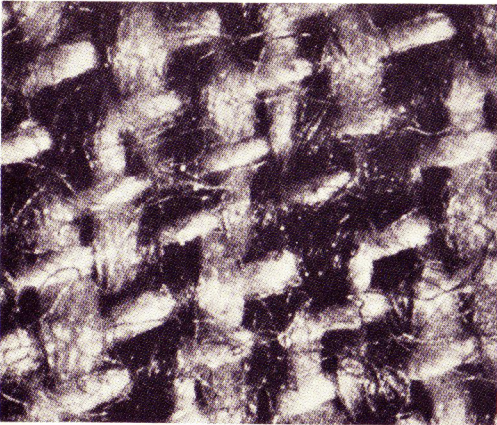

Figure 1. Macrophotograph.

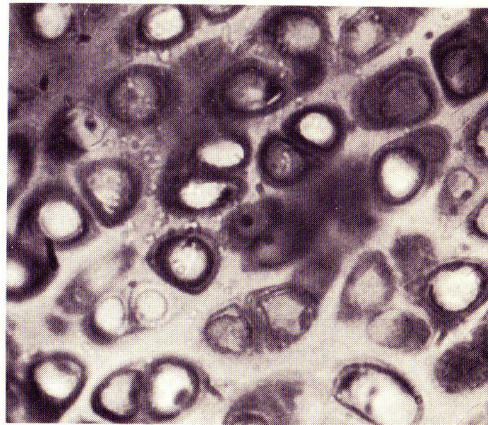

Figure 2. Photomicrograph.

## THE FOCASLIDE

You can make all types of close-up pictures with your Leica camera and the Focaslide . . . from a cluster of flowers down to the head of a pin, to reveal detail which normally cannot be seen. Copying, nature photography, medical photography and a host of other picture-making opportunities are opened to you. Ground glass focusing is provided and the Focaslide can be used with all Leica lenses.

**How It Works:** The principle behind the Focaslide is simple: it enables the lens to be extended out from the camera, closer to the subject. This magnifies the image on the negative. The further the lens is extended from the camera, the greater is the image magnification.

The Focaslide extends the lens approximately 12mm. from the camera. To permit greater separation of lens from camera, a number of Extension Tubes are available in the following lengths: 7mm., 15mm., 30mm., 45mm., 60mm. and 90mm. The Tubes can be used singly, or together in tandem arrangement, to provide a series of extensions. Thus, with the use of two 90mm. and one 60mm. Extension Tubes, a subject only  $3/16 \times 9/32$  inches can be made to fill the entire negative area..

The Adjustable Micrometer Extension Tube is the ideal adjunct to the Focaslide, as it allows a wide range of Leica lenses to be used for copying work. Without adapters, it accepts all Leica lenses and gives a 20mm. range of adjustment between a 40mm. and 60mm. length of Extension Tube. Micrometer indexing of the mount enables accurate settings to be maintained for varying scales of copying work. Adapters are available for all 90mm., 127mm. and 135 mm. Leica lenses to convert the Adjustable Micrometer Extension Tube into a short focusing mount for use at infinity.

The Intermediate Focusing Mount insures crisp definition when photographing objects such as manuscripts. It obviates any distortion of the image due to the slight lateral displacement of the lens which will occur if a Leica camera lens, attached directly to the Focaslide, is focused in its free position.

The large selection of magnifiers facilitate rapid focusing of objects on the ground glass screen of the Focaslide. Extreme accuracy of focusing is assured with the 30x Magnifier by observing the air-image in the clear center-spot of the screen.

**How to Mount the Focaslide:** The Focaslide can be attached to a Ball-Jointed Tripod Head which is, in turn, secured to a steady tripod. The large Ball-Jointed Tripod Head definitely insures freedom from vibration. Its improved and rigid construction permits the camera to be swung and positively located at any angle. Less than a quarter-turn of the thumb-screw to either left or right, serves to release and lock the tripod screw instantly without effort.

The Focaslide can also be attached to the sliding arm used as an offset support on a Leitz enlarger baseboard and upright.

In either case, the Focaslide is fastened to its mounting by a screw through one of its two threaded sockets (4) on the Fixed Plate (B).



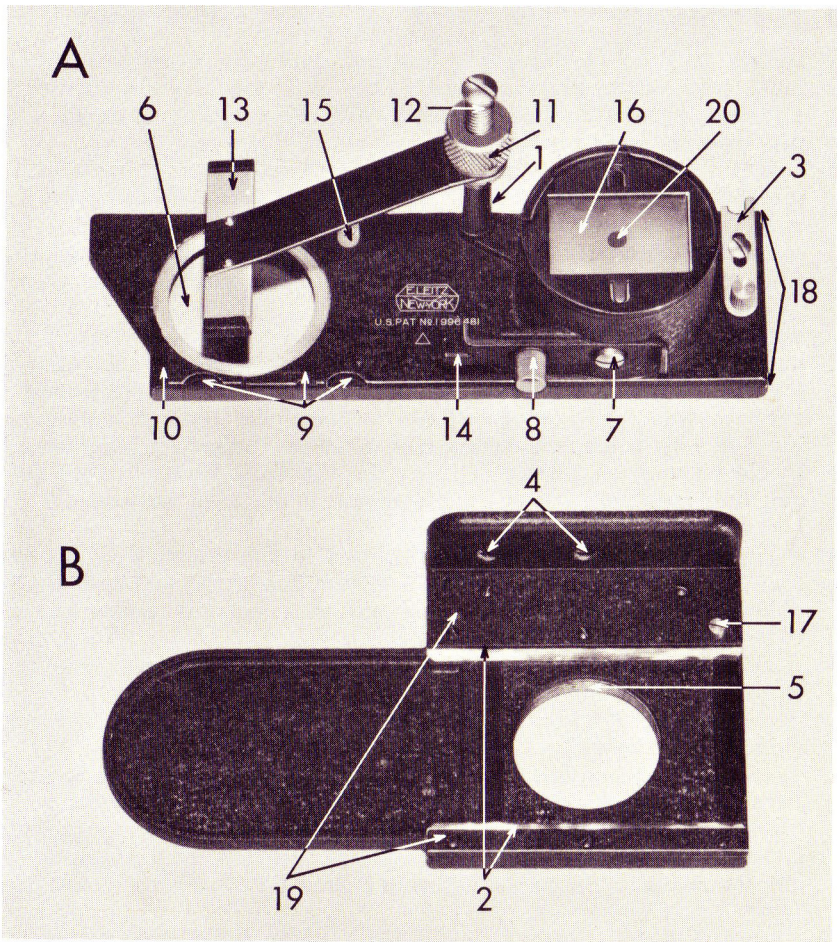

Figure 3. The Focaslide Sliding Plate and Fixed Plate.

### Nomenclature for Figure 3.

- |                                |                                  |
|--------------------------------|----------------------------------|
| A. Focaslide Sliding Plate     | 10. Cut-out for slow speed dial  |
| B. Focaslide Fixed Plate       | 11. Knurled nut                  |
| 1. Supporting post             | 12. Retaining screw              |
| 2. Dovetail grooves            | 13. Leather-padded spring clamp  |
| 3. Slotted locking lever       | 14. Camera positioning bar       |
| 4. Threaded sockets            | 15. Fixed stop                   |
| 5. Leica lens thread           | 16. Ground glass focusing screen |
| 6. Lens flange seat            | 17. Locking-bar stop             |
| 7. Retaining screw             | 18. Parallel dovetail runners    |
| 8. Knurled screw               | 19. Dovetail groove retainers    |
| 9. Rangefinder window recesses | 20. Aerial focusing clear spot   |



**Setting up the Focaslide:** The Focaslide consists of a sliding plate (A), fig. 2, with parallel dovetail runners (18) along its sides and a fixed plate (B) with parallel dovetail grooves (19). The Focaslide is supplied with the two parts fitted together.

Located on the sliding plate (A) of the Focaslide are: a leather-padded spring clamp (13) with knurled locking nut (11) for clamping the Leica camera body in position, a camera positioning bar (14) to align the camera, and a three-position sliding-bar (3) for positioning the ground glass screen (16) of the sliding plate (A) directly over the lens mounted in the threaded socket (5) of the fixed plate (B).

**Note:** Leica cameras having serial numbers lower than 400,000 are 1mm. smaller than higher serial numbered cameras; therefore it is essential that the camera positioning bar (14) be the correct size. A positioning bar engraved with a □ is used on Leica models under 400,000, a positioning bar with a △ is used on models over 400,000. The correct positioning bar should be specified when purchasing the Focaslide. However, they can be purchased separately, thus making it possible to adapt any Leica model to the Focaslide.

Place the Focaslide in the position shown so that the ground glass focusing screen (16) is at the right, and the lens flange seat (6) is to the left.

Loosen the knurled screw (8) and push the camera positioning bar as far to the right as it will go.

Turn the knurled nut (11) counter-clockwise as far as it will go — to the top of the supporting post (1). Swing the leather padded spring clip (13) to the right or left so that it will not be directly over the circular opening of the lens flange seat (6).

The Leica camera and the lens are attached to the Focaslide separately. After the lens has been unscrewed from the camera, the camera body is mounted on the sliding plate (A). The flange ring of the camera will fit into the lens flange seat (6). The rangefinder windows of the Leica will fall into the recesses (9) on the top of the sliding plate while the slow-speed

Figure 4. Setting the shutter speed before attaching the Leica to the Focaslide.

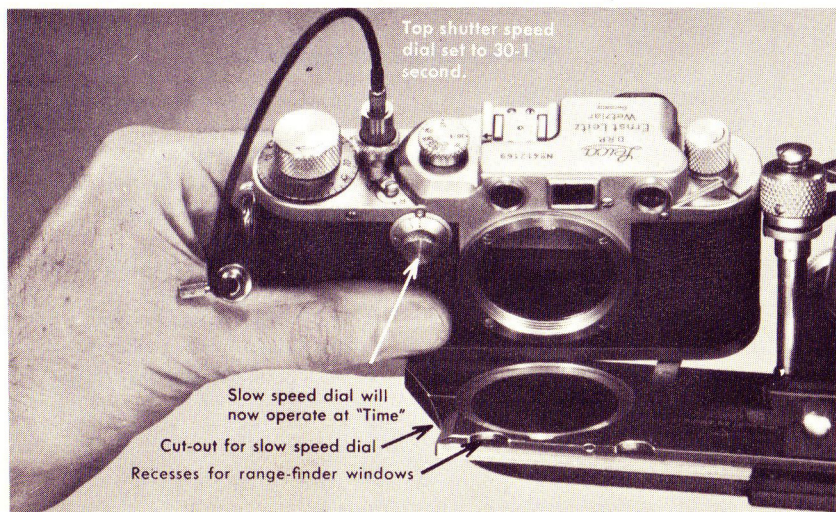



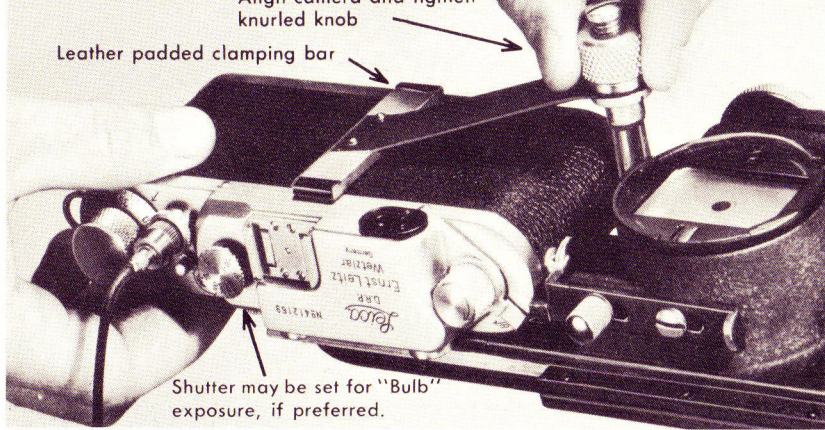

Figure 5. Clamping the camera on the Focalslide with the Spring Clamp.

dial of Leica or the slow-speed cover plate of the Leica (Models Ic and IIc) will fall into the cut-out (10) at the left end of the sliding plate.

Set the top shutter speed dial to 1/30 second. The Slow Speed Dial will now operate at "Time," or the shutter may be set for "Bulb" exposure if preferred.

Swing the spring clip to a position directly over the back of the Leica camera. Turn the knurled screw clockwise, tightening the spring clip against the camera. This holds the camera to the Focalslide.

Still holding the camera in position, push the camera positioning bar (14) as far to the left as the camera permits it to move, so that the forked end of the positioning bar is securely against the camera body. Secure the positioning bar by tightening the knurled screw (8) in a clockwise direction.

Screw the camera lens into the flange ring (5), from the underside of the fixed plate (B). If intermediate extension tubes are to be used, the male end of the tube or series of tubes is screwed into the flange ring, where the lens would normally go, while the lens screws into the threaded receptacle at the other end of the tube or series of tubes.

Figure 6. Aligning the camera with the Positioning Bar.

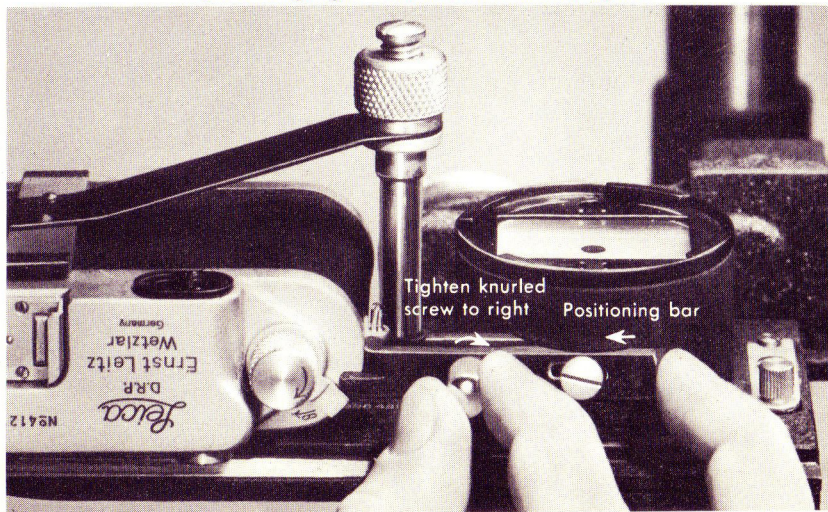



## Magnifiers for the Focalslide

Five magnifiers are available to facilitate focusing and image viewing on the ground glass screen of the Focalslide. These are:

- 5x Magnifier with focusing sleeve
- 5x Wide-Field Magnifier with focusing collar
- 5x Wide-Field Angular (90°) Magnifier with focusing collar
- 4x Wide-Field Angular (90°) Image Reversing Magnifier with focusing collar
- 30x Magnifier with focusing sleeve

The regular 5x and wide-field 5x magnifiers are interchangeable, serving the same purpose. The regular magnifier shows only a portion of the focusing screen, whereas the wide field magnifiers permit viewing the entire area without the necessity of moving the eye.

The 5x and 4x angular magnifiers permit viewing the image from the side of the Focalslide, which is convenient when using the equipment on the upright pillar with sliding arm. The 5x angular magnifier shows the image right side up, but reversed right and left; the 4x angular image reversing

Figure 7. 5x Wide-Field Angular (90°) Magnifier with focusing collar.



Figure 8. The 30x Magnifier over the clear center spot of the focusing screen, for observation of aerial images.





magnifier shows the image right side up and correct as to right and left.

The 30x magnifier is used where most critical focus is required. It positions over the clear central spot of the ground glass and views an aerial image, the same as if the ground glass were removed from the Focalslide.

Mount the magnifier to be used over the ground glass screen of the Focalslide, using a rotating motion to engage the bayonet flanges on the base of the magnifier with the bayonet catches on the collar holding the ground glass screen. Adjust the focusing sleeve or collar of the magnifier until the cross lines in the central clear portion of the focusing screen are sharp. The Leica lens is then focused until the image viewed through the magnifier is sharp.

When using the low power magnifiers, the clear spot is ignored and the image focused on the ground portion of the screen. When using the 30x magnifier the clear spot only is employed. Correct focus is assured when the image remains stationary in relation to the cross lines as the eye is moved from side to side. This is known as parallax focusing.

Because of the shallow depth of field prevailing in close-up photography, it is best to focus with the lens diaphragm at full opening, stopping to a smaller aperture when the image is sharp.

Figure 9. The four bayonet flanges of the 5x Magnifier fit the bayonet catches.



Figure 10. The large wide field magnifier is similarly fitted to the bayonet catches.







Figure 11. Locking lever at full forward position for removing sliding plate.



Figure 12. Locking lever at full back position for focusing.

**Operating the locking lever:** When the Focaslide is supplied, the slotted locking lever (3) has been pushed back as far as it will go, so that its curved end snugly engages the stop (17) on the fixed plate. The sliding plate cannot move in either direction and the ground glass screen is positioned directly over the lens.

The locking lever has three positions: pushed as far back as it will go; pulled forward as far as it will go, in which case the sliding plate can move in two directions; a mid-way position to which the locking lever can be set. This latter position can be "felt" through a sprung stop in the locking lever mechanism, and it permits the sliding plate to be moved in one direction only.

Lubricate the parallel dovetail runners (18) and grooves (19) occasionally with Vaseline. By pulling forward the slotted locking lever as far as it will go, the sliding plate can be removed for cleaning and lubricating.

## HOW TO USE THE FOCASLIDE

In copy work it is necessary to stop the diaphragm of the lens down to at least  $f/6.3$  in order to obtain sufficient depth of field. This, plus the fact that the use of extension tubes requires increased exposures, results in relatively long exposures. It is therefore necessary to prevent vibration of the copying equipment.

Center and focus the image that appears on the ground glass focusing screen of the Sliding Plate. If the Focaslide is mounted on the baseboard and upright of a Leitz enlarger, through the use of a Sliding Arm, centering of the image is best accomplished by moving the object to be photographed.

Rough focusing is done by moving the Focaslide to or away from the subject. If the baseboard and upright of a Leitz enlarger are being used in conjunction with a Sliding Arm, this is simply accomplished by moving the Arm along the enlarger upright until the proper position is attained. When the image on the ground glass is fairly sharp, the lens itself is critically focused. This can be done by rotating the mount of the lens in the normal manner.

After the image has been centered and focused on the ground glass screen, move the locking lever on the Sliding Plate, to its intermediate position so that the Plate will be free to move in only one direction. Move the Plate in this "free" direction until it is arrested by the fixed stop. The camera opening will be directly over the lens and the exposure can be made.

To refocus and recompose a new subject, move the Sliding Plate back so that the circular housing having the ground glass focusing screen is over the lens. Press the locking lever as far back as it will go so that it fully engages stop. Recompose and refocus.

**Lens Choice:** For use with the Focaslide, the 50mm. Elmar lens is recommended. Leica lenses having rigid mounts can also be used with the Focaslide.

**Note:** *Because of its thickness, the Focaslide acts like a 12mm. Extension Tube, so that the lens used with it is further away from the film plane than it would be if screwed directly into the camera lens opening. Lenses with rigid mounts cannot, therefore, be focused at relatively large distances up to infinity.*

When objects with appreciable thickness are to be reproduced, the use of longer focal length lenses than one of 50mm., such as 90mm., or 135mm., is advisable to obtain better perspective.

With longer focal length lenses, greater working distance is permitted between the lens and subject. Conversely, when lenses of shorter focal length are employed, the working distance between the lens and subject is shorter.



## EXTENSION TUBES

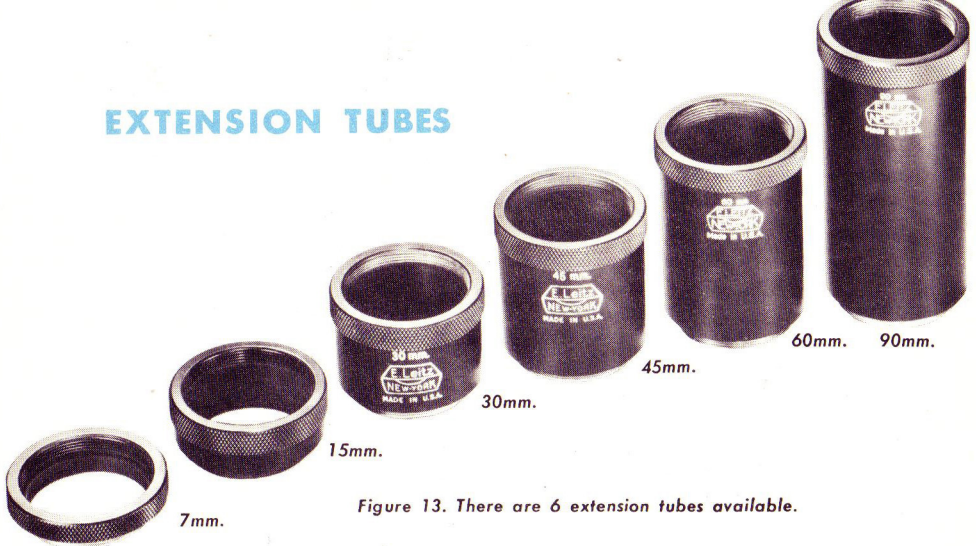

Figure 13. There are 6 extension tubes available.

To permit greater separation of lens from camera, extension tubes are available in the following lengths: 7mm., 15mm., 30mm., 45mm., 60mm., and 90mm. The tubes can be used singly, or together in tandem arrangement, to provide a series of extensions. Thus, with the use of two 90mm. and one 60mm. extension tubes, a subject only  $3/16 \times 7/32$  inches can be made to fill the entire negative area.

## ADJUSTABLE MICROMETER EXTENSION TUBE

The Adjustable Micrometer Extension Tube is engineered with the same precision as a focusing mount for a Leica long-focus lens. It is the ideal adjunct to the Focaslide, as it allows a wide range of Leica lenses to be used for copying work. Micrometer indexing of the mount enables accurate settings to be maintained for varying scales of copying work.

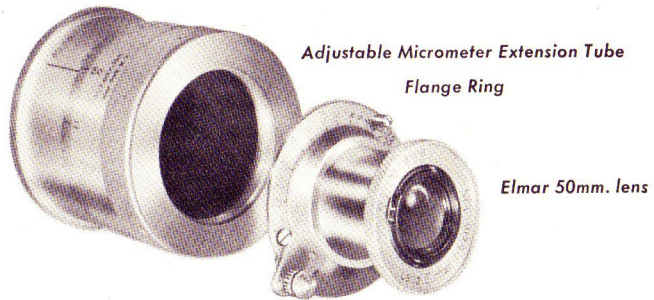

Figure 14. Extension tube, flange ring and 50mm. Elmar lens.

When used in conjunction with the extension tubes as an adjustable micrometer extension, it gives a 20mm. range of adjustment.

With the flange ring supplied, it accepts all Leica lenses in their normal mount and offers a range of adjustment from 40mm. to 60mm.

Leica 50mm. lenses screw directly into the flange ring of the micrometer extension tube. Adapters are available for all 90mm., 127mm., and 135mm. Leica lenses.

When using the 90mm., 127mm., and 135mm. lenses with the appropriate adapter, focusing at infinity on the ground glass of the Focaslide is possible. The complete Leica lens assembly is removed from its focusing mount and screwed into the adapter designed for it; this, in turn, is fitted to the adjustable micrometer tube. The 127mm. and 135mm. adapters screw into the flange ring supplied with the tube. The 90mm. adapter replaces it and screws directly into the tube.

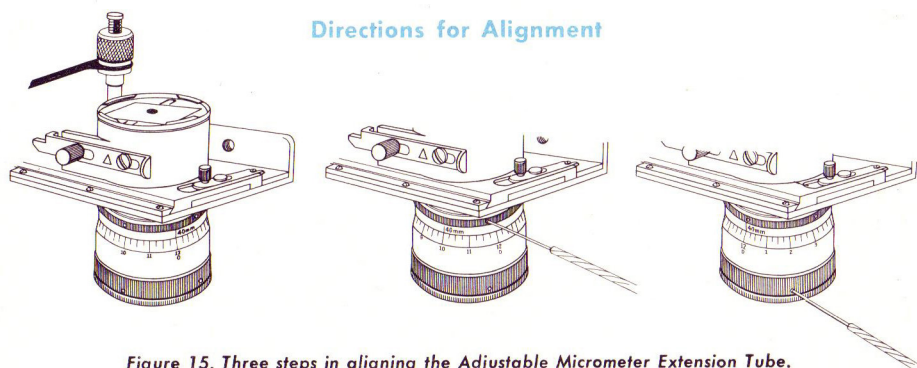

Figure 15. Three steps in aligning the Adjustable Micrometer Extension Tube.

**A.** Screw the adjustable micrometer tube into the threaded flange of the Focaslide, seating it tightly and setting for the shortest extension of 40mm. The focusing index will possibly not align with the front of the Focaslide, but at some intermediate position.

**B.** Use a small jeweler's screwdriver and loosen the three counter-sunk set screws in the top knurled ring of the micrometer tube. Turn the ring until the focusing index is facing to the front of the Focaslide. Retighten the set screws.

**C.** Loosen the three counter-sunk set screws in the bottom knurled ring of the micrometer tube. Turn the ring until the  $\frac{12}{0}$  line is in alignment with the focusing index. Retighten the set screws.

Care should be taken when making this adjustment that the focusing mount is not moved. It should remain at its shortest extension.

The adjustable micrometer tube may be taken off the Focaslide and replaced as often as desired with complete assurance that the focusing index will always align correctly. When using the micrometer tube on another Focaslide, it may be necessary to reset the index.



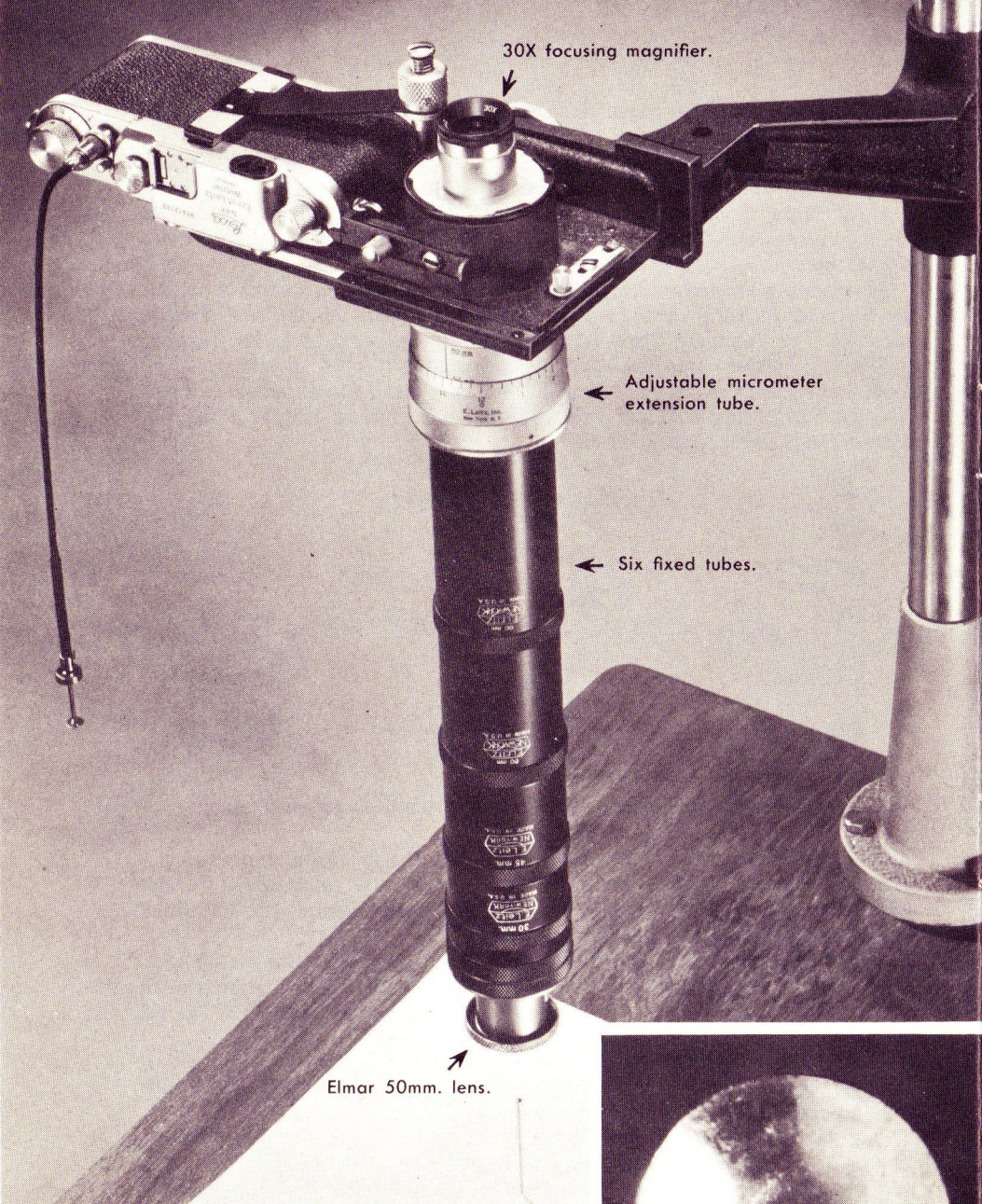
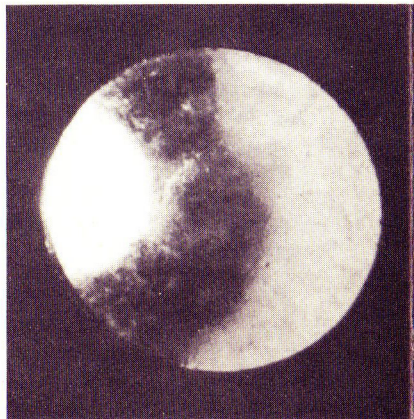

Figure 16. Even the head of a pin can be photographed! Negative on Panatomic film, one spotlight, one floodlight, 5 minutes exposure at  $f/18$ .





## Formula for Calculating Exposure with Extension Tubes

When Extension Tubes are used on the Focaslide the lens is moved further away from the film plane in the camera. This reduces the relative amount of light reaching the film so that an increase of exposure is necessary. The amount by which exposure must be increased over that required without Extension Tubes may be calculated from the following formula:

$$T = \frac{D^2}{F^2}$$

*Explanation of Symbols:*

T — Exposure factor.

D — Distance from the lens to the film plane. This distance includes the focal length of the lens, plus the length of the Extension Tube or Tubes, plus the extension provided by the Focaslide (approx. 12mm.)

F — The focal length of the lens used.

*Example:*

What is the exposure factor when using a 50mm. lens with a 45mm. extension tube?

Exposure Factor = Focal length of lens, plus length of extension tube or tubes, plus extension of Focaslide squared.  
Focal length of lens squared

Amount of extension  $50 + 45 + 12\text{mm.} = 107\text{mm.}$

$$\frac{107 \times 107}{50 \times 50} = \frac{11,449}{2,500}$$

= 4.58 or approximately 4.6

Exposure Factor =  $4.6 \times$

A quick reference table giving exposure factors as well as other essential data when using 50mm. lenses and various Extension Tubes with the Focaslide is reproduced on the next page.

The table applies only to 50mm. Leica lenses. With lenses of shorter focal length, a given Extension Tube causes greater relative image magnification than it would with a 50mm. lens, and will require a correspondingly greater increase in the exposure factor. With a lens of longer focal length than 50mm., the same Extension Tube, will give rise to a relatively lower image magnification factor than the 50mm. lens and will not require as great an increase in exposure as that necessary for a 50mm. lens.



**Lens Adapters:** Adapters are available for all 90mm., 127mm. and 135mm. Leica lenses to convert the adjustable micrometer extension tube into a short focusing mount for use at infinity. The versatility of this accessory is extended by these four adapter rings which accept the lens components of the following lenses: the 90mm. Elmar f/4; 90mm., f/4.5; 127mm., f/4.5; and the 135mm. Hektor f/4.5 (long-focus) lens.

When using the 90mm. Leica lenses, the flange ring at the end of the adjustable micrometer extension tube must be removed by unscrewing in a counter-clockwise direction. The adapter is then inserted in its place. Then mount the lens component to the adapter.



Figure 17. The flange ring must be removed before fitting either of the two 90mm. lens adapters to the Adjustable Micrometer Extension Tube.



Figure 18. Method of mounting 127mm. and 135mm. lens assembly in the Adjustable Micrometer Extension Tube.

When using the 135mm. or 127mm. Leica lenses on the adjustable micrometer extension tube, the flange ring remains in place and the adapter rings are screwed directly into the flange ring. Then mount the lens component to the adapter.



Table 1: Data for Focalslide Used with 50mm. Elmar and 50mm. Summar

Ratio of Reduction or Magnification	Area Covered in mm.	Distance Back of Camera To Object in mm.	Exposure Factor	Intermediate Focusing Mount and Extension Tubes in mm.	With Intermediate Focusing Mount Calibrations Set at
1:20	460 x700	1138	1.1	Int. F. M.	
1:19	436 x657	1085	1.1	Int. F. M.	
1:18	425 x645	1058	1.1	Int. F. M.	
1:17	392 x594	982	1.1	Int. F. M.	
1:16	368 x555	930	1.1	Int. F. M.	
1:15	345 x522	879	1.1	Int. F. M.	
1:14	320 x485	828	1.2	Int. F. M.	
1:13	300 x450	777	1.2	Int. F. M.	
1:12	275 x420	725	1.2	Int. F. M.	
1:11	250 x380	674	1.2	Int. F. M.	
1:10	227 x345	623	1.2	Int. F. M.	
1:9	203 x310	572	1.2	Int. F. M.	
1:8	182 x275	522	1.3	Int. F. M.	
1:7	160 x244	471	1.3	Int. F. M.	
1:6	137 x206	421	1.4	Int. F. M.	
1:5	125 x185	392	1.4	Int. F. M.	
1:4	70 x105	283	1.8	Int. F. M.+15:	Zero
1:3	48 x 72	242	2.0	Int. F. M.+15:	Out
1:2.5	38 x 57	223	2.5	Int. F. M.+30:	Zero
1:2	30 x 46	215	2.8	Int. F. M.+30:	Out
1:1.5	25 x 40	212	3.5	Int. F. M.+45:	Zero
1:1	24 x 36	208	4.0	Int. F. M.+45:	Out
1.25x	20 x 30	214	5.0	Int. F. M.+60:	Zero
1:5x	18 x 26	216	6.3	Int. F. M.+60:	Out
1.75x	13 x 20	232	7.7	Int. F. M.+90:	Zero
1.2x	12 x 18	236	9.0	Int. F. M.+90:	Out
2.2x	11.5x 17.5	240	10.0	Int. F. M.+90+15:	Zero
2.4x	10.5x 15.5	246	11.0	Int. F. M.+90+15:	Out
2.5x	10 x 15	253	12.0	Int. F. M.+90+30:	Zero
2.65x	9.5x 14.5	259	13.0	Int. F. M.+90+30:	Out
2.75x	9 x 13.5	265	14.0	Int. F. M.+90+45:	Zero
2.85x	8.5x 13	272	15.0	Int. F. M.+90+45:	Out
3x	8 x 12	278	16.0	Int. F. M.+90+60:	Zero
3.5x	7.5x 11.5	284	18.0	Int. F. M.+90+60:	Out
3.8x	7 x 10.5	306	21.0	Int. F. M.+90+60+30:	Zero
4x	6 x 9	312	25.0	Int. F. M.+90+60+30:	Out
4.5x	5.5x 8	360	29.0	Int. F. M.+90+60+60:	Zero
5x	5 x 7	369	36.0	Int. F. M.+90+60+60:	Out



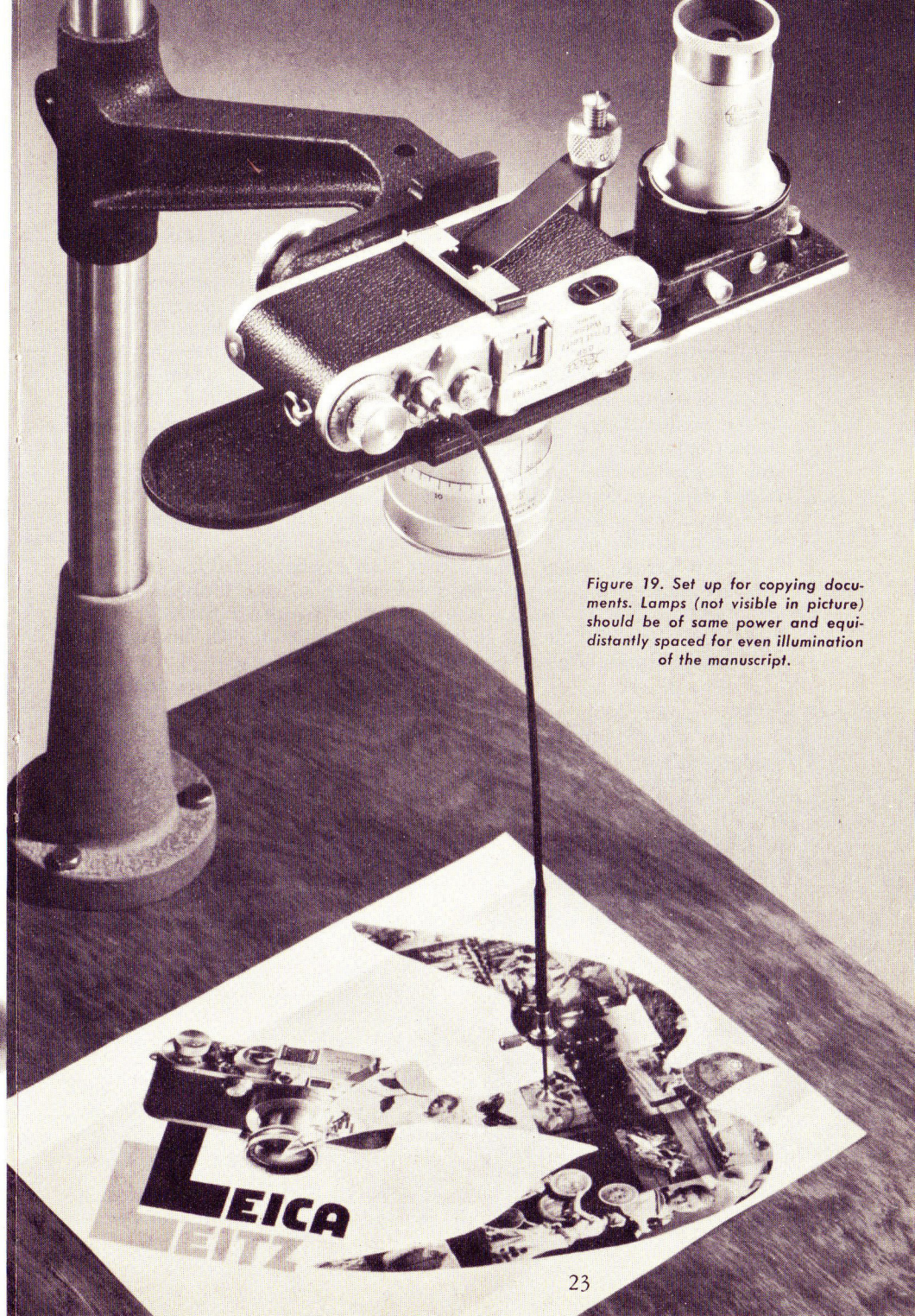

*Figure 19. Set up for copying documents. Lamps (not visible in picture) should be of same power and equidistantly spaced for even illumination of the manuscript.*



**Exposure Calculation:** To apply an exposure factor (as determined by the formula) it is first necessary to determine the "normal" exposure for the subject. With small subjects this presents a difficulty when using a photoelectric exposure meter, for the subject may be the same size, or even smaller than the cell window of the meter. The problem can be solved by first arranging the lighting units for properly illuminating the subject, then substituting for the latter a card which is approximately the same shade as the subject. The exposure meter reading is then made of this card.

To insure that a well exposed negative is obtained, it is recommended that a series of exposures be given on each subject. At least three exposures should be made: one, the exposure calculated; the second, double the calculated exposure; and the third, half of the calculated exposure. For greater insurance, a five-exposure strip is recommended, with in addition to the exposures mentioned includes exposures representing four times and one-quarter of the determined exposure. When darkroom facilities are available, single exposures can be made and checked.

**Film Choice:** In close-up and copy work it is usually necessary to reproduce as fine detail as possible. This calls for the use of fine-grain films, since the finer the inherent grain in the film, the greater is the ability of the film to reproduce detail.

For this purpose the finer grain 35mm. films may be divided into two types:

- a. Medium speed, fine grain films:—Examples of such films are DuPont Superior No. 1, Eastman Panatomic X, and Ansco Finopan.
- b. Slow speed, extreme fine grain films:—Examples of such films are Eastman Microfile, Ansco Minipan and DuPont Microcopy.

For general work the medium speed films are recommended. They have good latitude and are capable of reproducing delicate gradations. When maps, charts, etc., are to be copied, in which case "speed" of the film may not be essential, the slow speed films are recommended because of their ability to resolve fine detail. In those cases where only black and white charts, etc., are to be copied, positive film can be employed. This film is ordinarily used to make film positives from 35mm. negatives. It is relatively cheaper in price than negative film and can be employed in copy work where no colored material is to be copied.

In those cases where moving objects are encountered, which would necessitate relatively high shutter speeds, it may be necessary to use high speed films.

Figure 20. Locking pin on wire release leaves hand free for long exposures when shutter is operated on bulb setting.

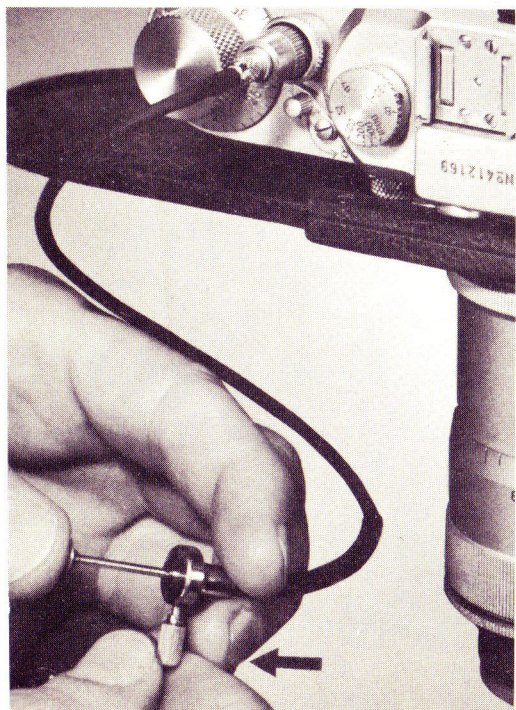



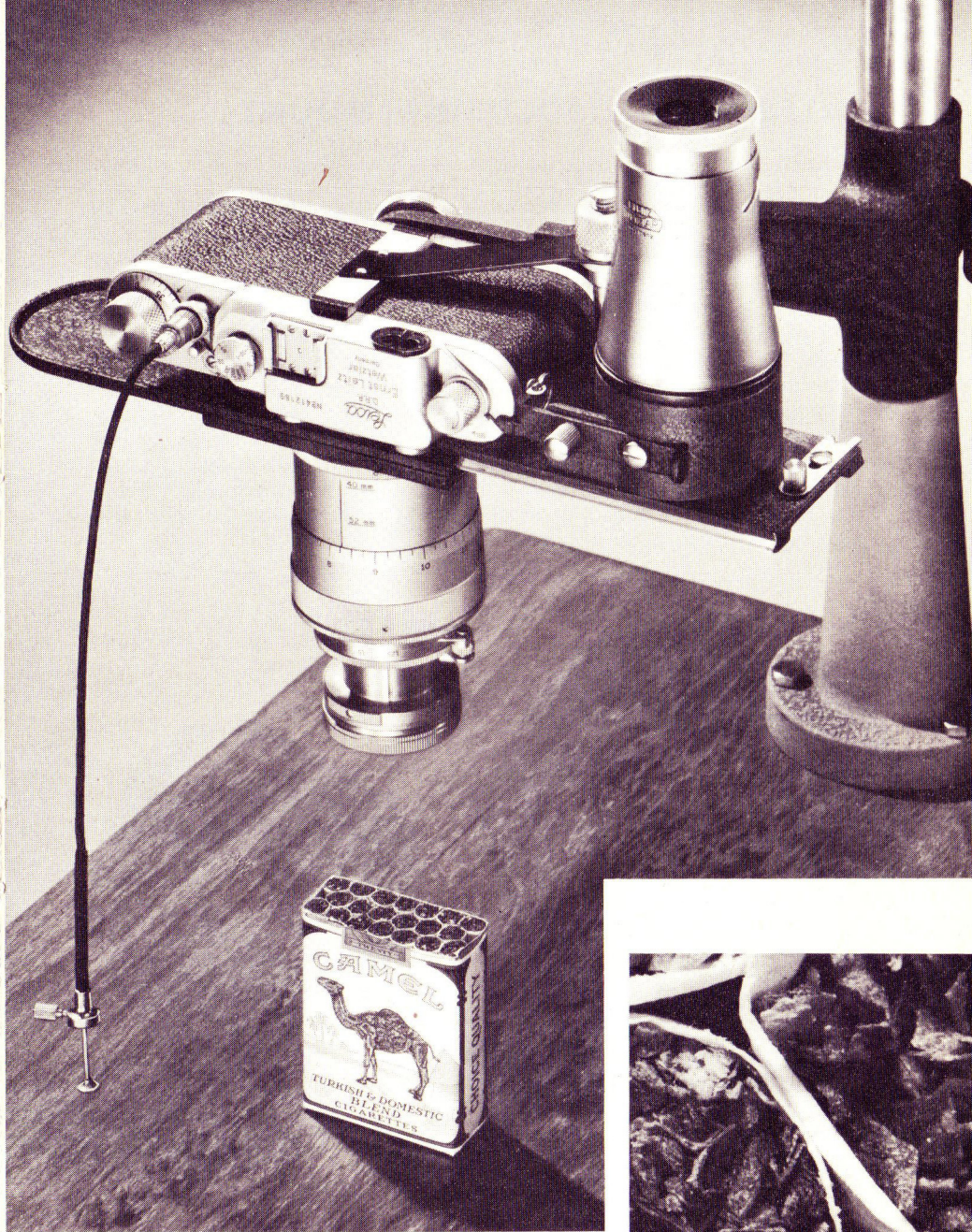

Figure 21. Typical set-up for "Quiz" pictures. For this type of work a small spotlight is ideal.



## INTERMEDIATE FOCUSING MOUNT

The Intermediate Focusing Mount is a valued copying accessory, attaching to the bayonet flanges of the Leica 50mm. lenses, thus ensuring a rigid mounting. It also prevents any possible distortion of the image due to the slight lateral displacement of the lens, which may occur when the Leica 50mm. lens, attached directly to the Focaslides or the extension tube is focused in its free position. The Intermediate Focusing Mount gives a wide range of picture-taking possibilities. When it is attached directly to the Focaslides and the 50mm. Elmar or Summitar lenses, it makes possible the photography of objects at distances from infinity to 15¼ inches, from the back of the camera to the object. A 5 x 7½-inch area is covered at the closest distance. Still smaller areas are easily covered by inserting any of the extension tubes between the lens and the Focaslides. The Intermediate Focusing Mount gives a variable extension of 7.5mm. and can be used as a focusing aid for fine adjustments.

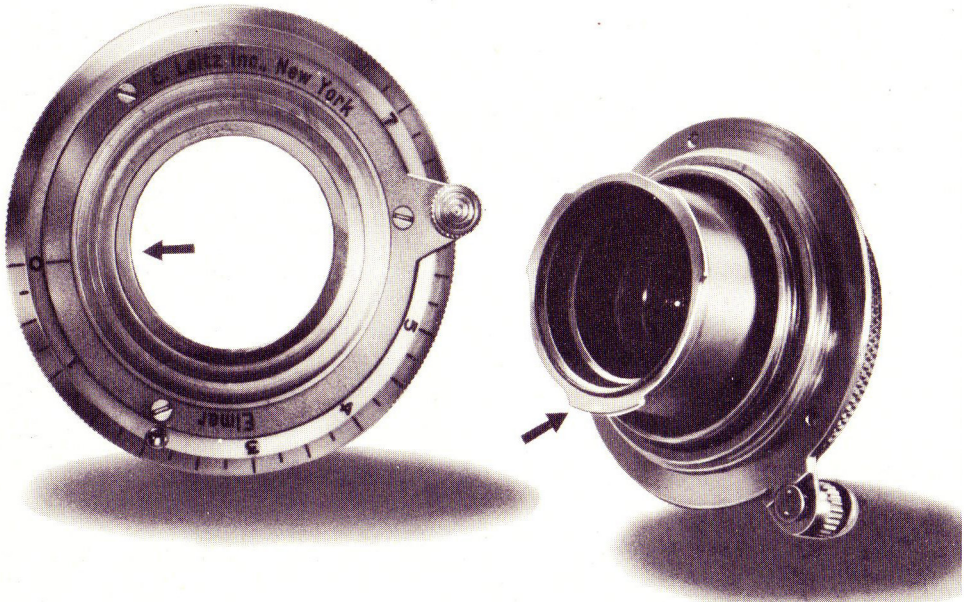

Figure 22. Bayonet flanges of 50mm. lens assembly engage the bayonet catches of the Intermediate Focusing Mount.

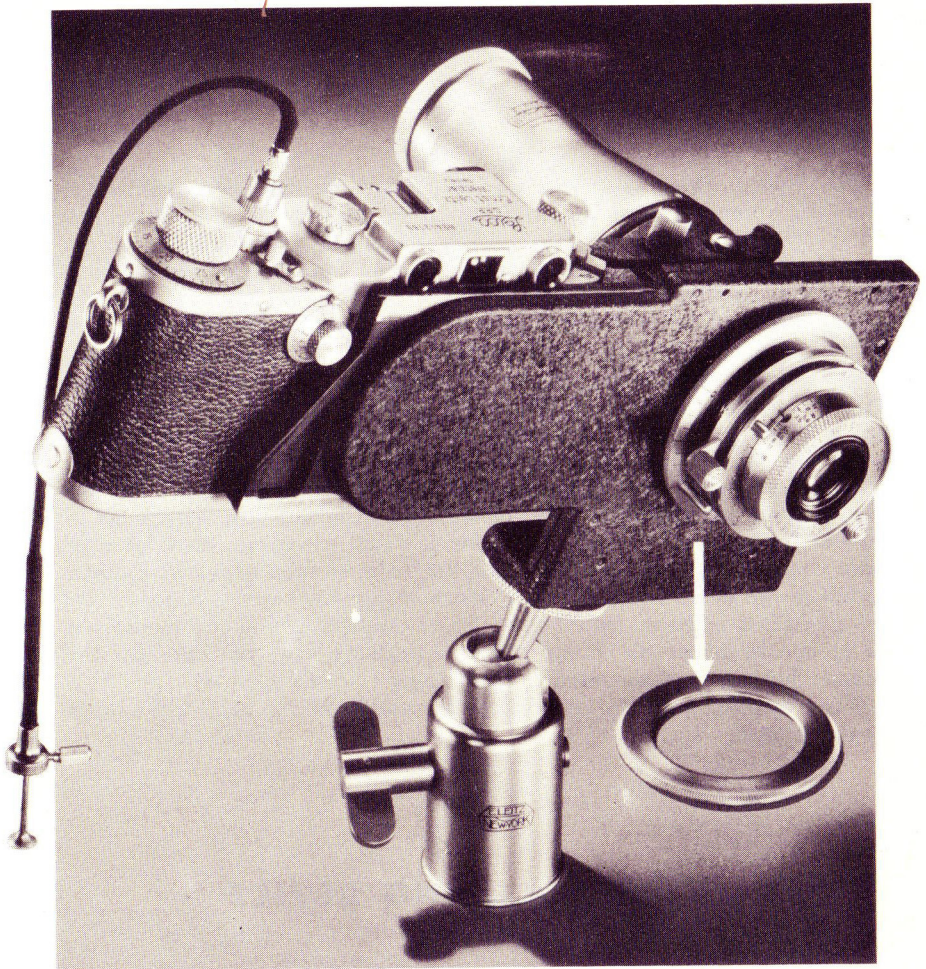

Figure 23. The compensating ring is detached when lens in the Intermediate Focusing Mount is used at infinity.

**The Compensating Ring:** When the Intermediate Focusing Mount is used for normal copy work, the compensating ring remains in its usual position at the point of contact between the lens thread of the Focalslide fixed plate and the focusing mount. When working outdoors at infinity with the Leica camera on the Focalslide and a tripod, unscrew the compensating ring from the Intermediate Focusing Mount in a counter-clockwise direction. Attach the mount, without the ring, directly to the lens thread of the Focalslide. Turn focusing mount out for sliding clearance then back to proper setting.



## OPTICAL SHORT DISTANCE FOCUSING DEVICE

The Optical Short Distance-Focusing Device for the Leica enables the automatic focusing of the Leica lenses to be utilized for close-ups under 3.5 ft. With this device, all object distances between 3.5 ft. and 16½ in. to the plane of the film (back of camera) can be set with rapidity and accuracy. One is not confined to some predetermined focusing distances (as with our setting devices for the use with front lenses and intermediate collars), but can set the lens continuously to all distances between the limits quoted. The ratio of image varies from  $17.5 \times$  to  $6.3 \times$  minification, the size of object from  $16\frac{1}{2}'' \times 24\frac{7}{10}''$  to  $5\frac{9}{10}'' \times 8\frac{9}{10}''$  ( $42 \times 63$ cm. to  $15 \times 22\frac{1}{2}$  cm.). The device consists of an intermediate helical focusing arrangement which is screwed into the lens changing flange of the Leica. This accessory has an optical glass wedge, which positions in front of the rangefinder window providing the necessary deflection of the rays. A square stop which fits in front of the viewfinder, which, by means of a cam movement, provides automatic compensation for parallax, and the reduced field of view. Bayonet catches in the optical short distance device engage the bayonet flange of the lens when it is inserted. Only 50mm. lenses can be used and two models are made, one to accept the Elmar 50mm. (NOOKY) and the other for the Hektor, Summar and Summarit 50mm. lenses (NOOKY-HESUM).

When focusing with the device, only the middle of the field of the range should be used.

## OPTICAL NEAR FOCUSING DEVICE

OMIFO is a near focusing device similar to NOOKY except that it offers a fixed focus with a fixed ratio of 1:4, covering approximately 4x6 inches. It is designed to accommodate the 90mm. Elmar f/4 lens. This combination affords a greater working distance than the 50mm. lens used with the Nooky.

The device consists of an intermediate mount which is screwed into the lens changing flange of the Leica. In addition, the mount accommodates optical wedges that position in front of both rangefinder windows, and a diminished stop in front of the viewfinder window. This arrangement provides the necessary deflection of rays and permits critical focus, as well as indicating the correct field of view. The lens *must* be focused at infinity.



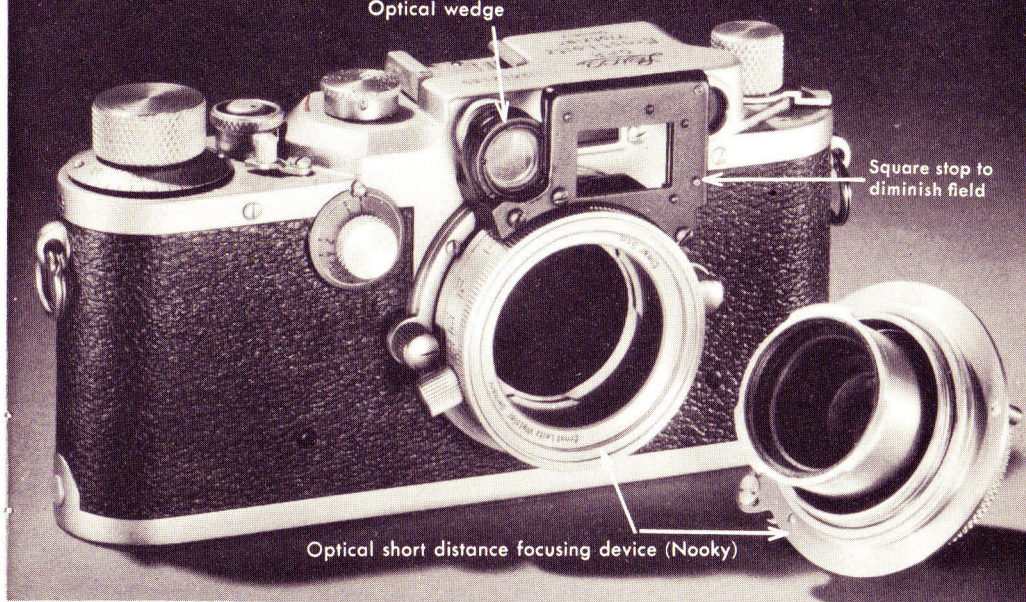
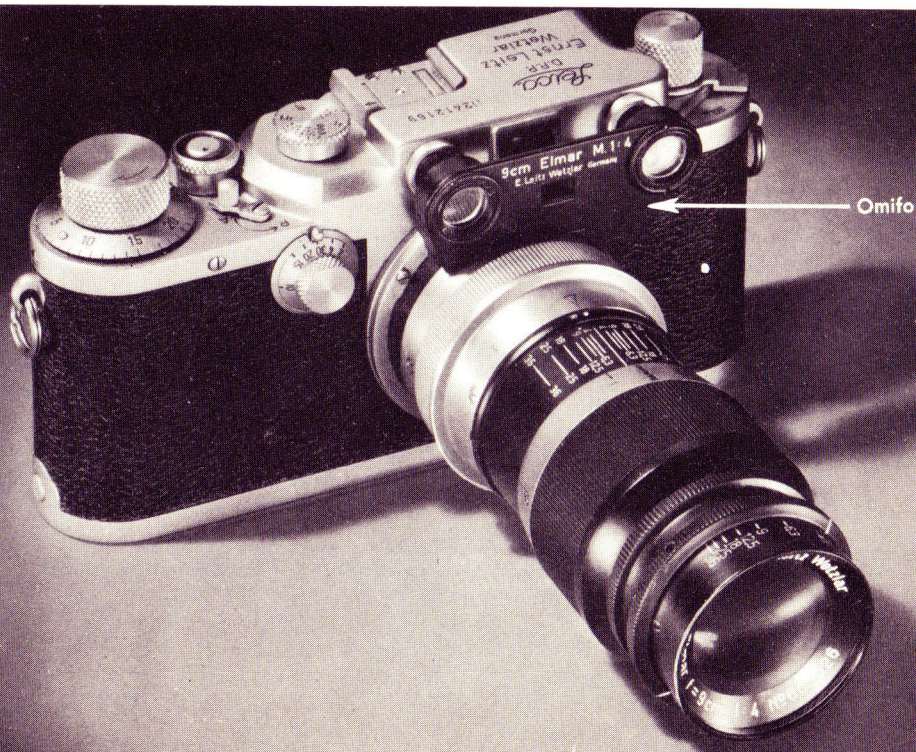

Figure 24. Bayonet flanges of 50mm. lens assembly engage bayonet catches in the Optical Short-Distance Focusing Device, "NOOKY" or "NOOKY-HESUM."

Figure 25. Optical Near-Focusing Device, "OMIFO," with 90mm. Elmar lens attached to the Leica camera.





**TABLE II — COMPARISON CHART OF**

Accessory	Used With	Extension	Lenses Used
<b>Micrometer Extension Tube</b>	Focalslide or Focalslide and fixed extension tubes	40mm. to 60mm. (variable)	Elmar 50mm.
			Summitar 50mm.
			Elmar 90mm.
			f/4.5 90mm.
			f/4.5 127mm.
Hektor 135mm.			
<b>Intermediate Focusing Mount</b>	Focalslide or Focalslide and extension tubes (except 7mm. tube)	7.5mm. (variable)	Elmar 50mm. Summitar 50mm. (separate intermediate mount for each lens)
<b>Optical Short-Distance Focusing Device</b>	Any Leica with coupled rangefinder	5mm. (variable)	Elmar 50mm. Summitar 50mm. (separate device for each lens)
<b>Optical Near-Focusing Device</b>	Any Leica with coupled rangefinder	22.5mm. fixed	Elmar 90mm. (set at $\infty$ )

## AUXILIARY REPRODUCTION DEVICES

In addition to the Focalslide, Bellows Focusing Device and other equipment for close-up photography, with provisions for visual focus, there are available additional reproduction devices designed for portability and easy use.

The Auxiliary Reproduction Devices are of two general types; those using intermediate tubes of fixed length between the Leica and lens, and those using supplementary lenses placed in front of the Leica 50mm. lens. Some of these devices are fixed focus for photographing stamps, finger prints and other subjects at ratios of 1:1. Some are equipped with adjustable legs, which when set and used with the proper tube or front lens, maintain the correct focus distance and outline the area to be photographed.

The supplementary front lenses may be used without the auxiliary accessories by measuring the distance from the back of the Leica to the material to be photographed.

Complete information and instructions for using the auxiliary reproduction devices and the supplementary front lenses are contained in separate booklets available at \$.15 each.

*Figure 26. Universal focusing arrangement, "BAZOO," with adjustable legs for use with tubes giving ratios of 1:1.5, 1:2, and 1:3 and adjustable legs with extensions for use with supplementary front lenses numbers 2 and 3.*

## ACCESSORIES FOR CLOSE-UP PHOTOGRAPHY

Auxiliary Equipment	Focusing Range (Back Of Camera To Object)	Size of Object Closest — Farthest Distance
Flange Ring*	8 $\frac{3}{4}$ " to 9"	5 $\frac{5}{8}$ "x7 $\frac{5}{8}$ " to 7 $\frac{5}{8}$ "x13 $\frac{5}{8}$ "
Flange Ring*	8 $\frac{3}{4}$ " to 9"	5 $\frac{5}{8}$ "x7 $\frac{5}{8}$ " to 7 $\frac{5}{8}$ "x13 $\frac{5}{8}$ "
Adapter**	25" to $\infty$	4 $\frac{1}{4}$ "x6 $\frac{1}{2}$ " to $\infty$
Adapter**	25" to $\infty$	4 $\frac{1}{4}$ "x6 $\frac{1}{2}$ " to $\infty$
Adapter**	46" to $\infty$	6 $\frac{1}{2}$ "x9 $\frac{3}{4}$ " to $\infty$
Adapter**	52" to $\infty$	7"x10" to $\infty$
Compensating Ring	15 $\frac{1}{4}$ " to 48 $\frac{1}{2}$ "	5"x7 $\frac{1}{2}$ " to 17"x25 $\frac{1}{2}$ "
Compensating Ring removed	18" to $\infty$	6"x9" to $\infty$
None	16 $\frac{1}{2}$ " to 39 $\frac{1}{2}$ "	6"x9" to 16"x24"
None	22 $\frac{1}{2}$ " (fixed focus)	4"x6" (fixed area)

\*Supplied With Adjustable Micrometer Extension Tube  
\*\*Separate adapters for each lens

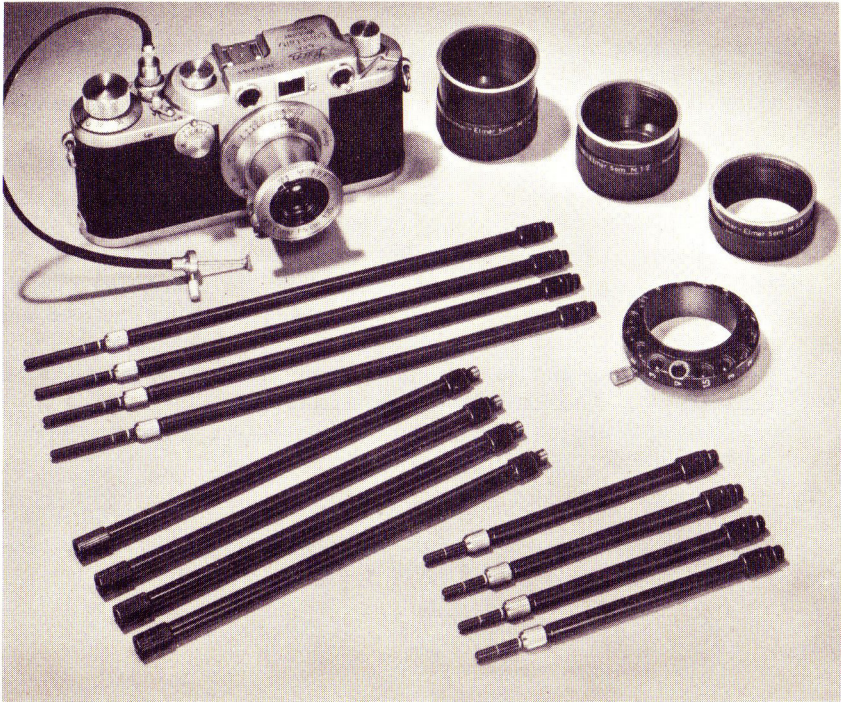



TABLE III — AREAS COVERED BY LEICA LENSES

Lens on Camera			Lens on Focaslide Without Extension Tubes		
Lens mm.	Minimum Focusing Distance	Area At Closest Distance	Nearest Distance	Farthest Distance	Front of Lens To Object At Closest Distance
28	3½'	35" x 52½"	2" x 3"	2¼" x 3½"	3"
35	3½'	27" x 40½"	2¼" x 3½"	2¾" x 4"	4½"
50*	3½'	18" x 27"	3½" x 5¼"	4" x 6"	8⅝"
85	5'	15½" x 23"	4" x 6"	6¼" x 9½"	15½"
90	3½'	9½" x 14¼"	3¾" x 5½"	6¾" x 10"	17¾"
127	5'	9½" x 14¼"	4½" x 6¾"	9½" x 14¼"	27¾"
135	5'	8¾" x 13"	4½" x 6¾"	10" x 15"	31"
200	10'	12¼" x 18½"	Areas given to closest ¼".		
400	25'	16" x 24"			

\*50mm. lenses extended and locked.

## PHOTOMICROGRAPHY WITH THE FOCASLIDE

Photomicrography with the Leica camera, Focaslide and microscope.

This setup permits the use of the Focaslide, with ground glass focusing, for taking photomicrographs, with any standard microscope, in a manner similar to the Micro-Ibso method.

1. Attach the sliding arm and Focaslide with Leica to the upright of baseboard.
2. Screw conical extension tube into lens flange of Focaslide.
3. Screw upper light excluding ring onto conical extension tube.
4. Place microscope eyepiece into lower light excluding ring (which has white circle; arrow should point down) and place eyepiece and ring on monocular tube of microscope.
5. Lower sliding arm so that upper ring just covers white circle of lower ring. The connection is then light-tight.
6. Focus on Focaslide ground glass by means of coarse and fine adjustment of microscope.

Figure 27. Leitz GO 48/77 microscope, Leica IIIc camera, Focaslide, ½x conical extension tube and light excluding rings.



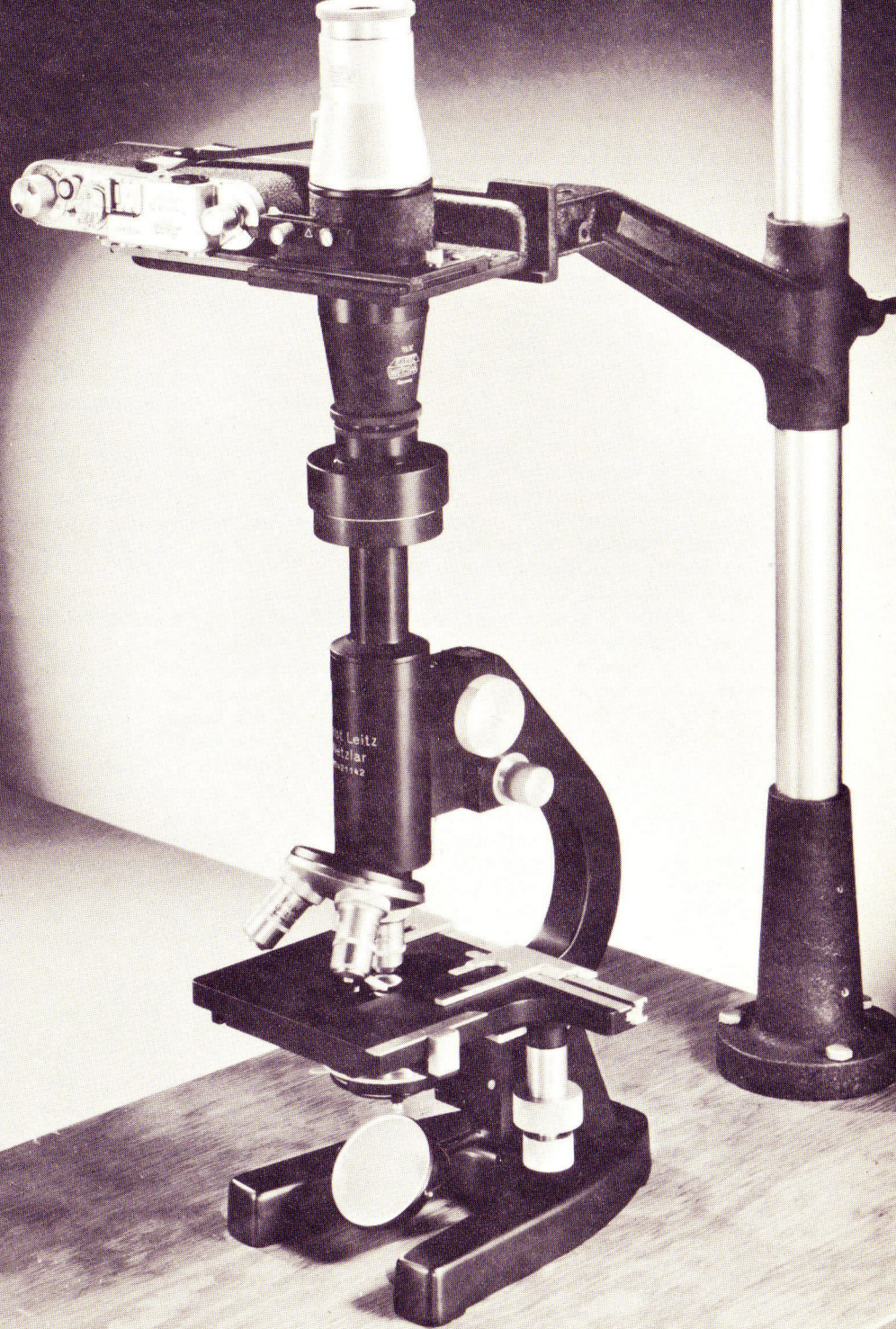



## THE MICRO-IBSO ATTACHMENT

For quick and accurate photomicrography, the Leitz Micro-Ibso attachment can be used with any microscope of standard make, a good microscope lamp and the Leica camera.

The Micro-Ibso attachment consists of a 10x Periplan (compensating) eyepiece, a main housing with built-in shutter, and a lateral viewing telescope. A conical extension tube with an achromatic lens system is set above the shutter.

A semi-silvered beam-splitting prism, designed to reflect 40 per cent of the light into the lateral viewing telescope is mounted in the main housing. The balance passes directly to the camera. The telescope is focused by a network of cross hairs visible in the lateral viewing telescope, which also frames the area of the field of view. The exposure is made when the telescope has been properly focused on the cross hairs, and the specimen has been aligned by means of the coarse and fine adjustment of the microscope itself. Two cable releases are provided — one to actuate the shutter, and the other the prism. The prism, therefore, can be thrown out of the path of the rays so that the full intensity of light passes through the film.

The microscope is set up in the usual manner, with the microscope lamp properly aligned and the substage condenser adjusted for maximum illumination and definition of the specimen to be photographed. The cross hairs in the lateral viewing telescope are then properly focused in order to compensate for any variation in the eyesight of individuals. Now the specimen is focused through the lateral telescope by means of the fine adjustment of the instrument itself. When both the cross hairs and the image to be photographed are sharp, the image on the film will also be sharp. Now ready for exposure, the cable release which actuates the prism is pressed in and, if necessary, locked. This swings the prism out of the way and permits full illumination to reach the film in the camera. The second cable release is then used to make the exposure (of course, after the shutter has been set to conform with the exposure required). Remember that the Leica shutter has to be open and *left open* while making photomicrographs. An Ibsor shutter, which is an integral part of the Micro-Ibso attachment, is used exclusively in this case. The shutter has the following speeds: Bulb, Time, 1 second, 1/2 second, 1/5th second, 1/25th second, 1/50th second, 1/125th second. After one exposure has been made and, before moving to the next, the Leica shutter has to be closed and the winding mechanism turned until the next frame is in place; then the camera shutter is reopened.

Only Leica cameras with interchangeable lenses may be used with this attachment. The standard camera lens must be removed and the cone-shaped funnel of the Micro-Ibso attachment screwed into the camera lens mount. In certain cases, it may be desirable to leave the prism in while taking the photograph, thus enabling the user to view the specimen while the picture is being taken. This, however, increases the exposure time.

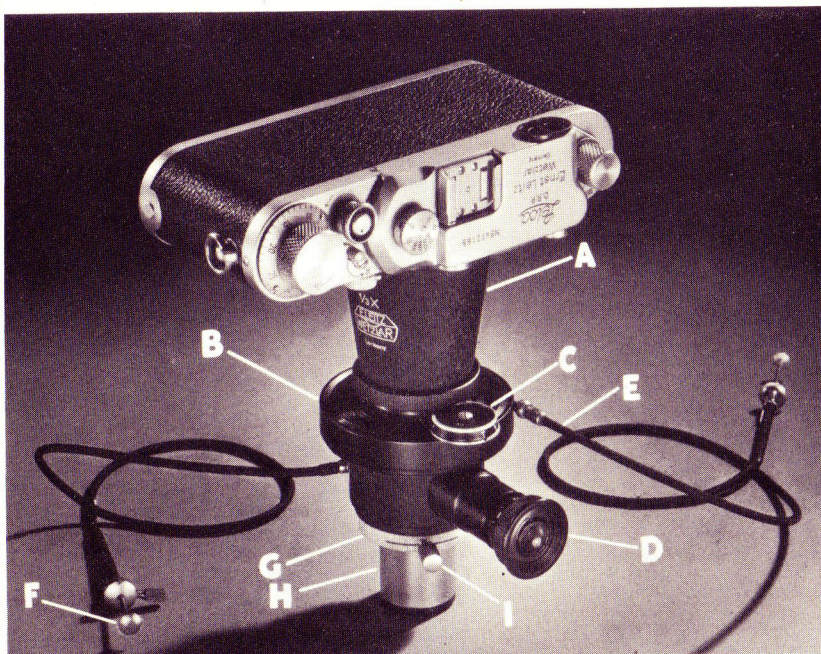

Figure 28. Micro-Ibso attachment mounted on the Leica camera.

- |  |  |
|--|--|
| <p>A. Cone-shaped funnel (with correction lens) which attaches to the Leica camera.</p> <p>B. Ibsor shutter.</p> <p>C. Shutter speed index.</p> <p>D. Focusing eye-piece.</p> <p>E. Cable release for shutter.</p> | <p>F. Cable release for reflecting prism.</p> <p>G. Knurled collar which screws into base of prism housing and holds the eye-piece</p> <p>H. 10x eye-piece (supplied).</p> <p>I. Set-screw to hold Micro-Ibso on microscope draw tube.</p> |
|--|--|

It is difficult to make a definite recommendation for a suitable film. Many of the leading microscopists prefer the slower but fine grain Eastman Micro-Film or Panatomic-X. A fine grain developer is preferred to retain the maximum detail on the negative — of great importance in photomicrography. For color work, one may use either the Ansco Color Tungsten or Kodachrome Type "A" film.

Assembly of the photomicrographic equipment involves but five simple steps. First, remove the lens from the camera and screw the Micro-Ibso attachment into the lens mount. The eyepiece is then removed from the microscope and the attachment inserted into the monocular body. Finally, tighten the set screws that hold the attachment rigidly in position on the microscope.



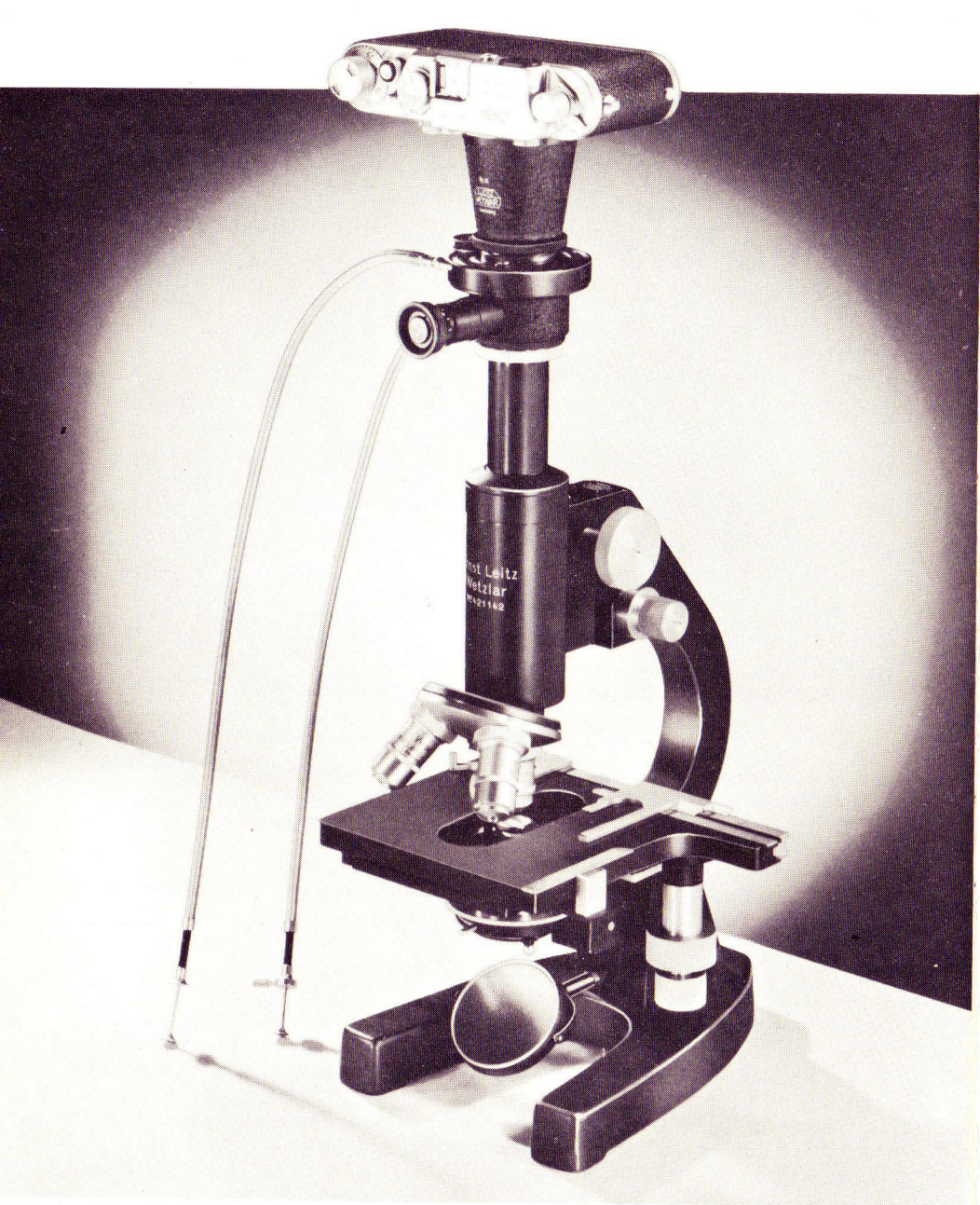

Figure 29. The Leitz GO 48/77 microscope fitted with the Micro-Ibso attachment and the Leica camera model IIIf.



## BELLOWS FOCUSING DEVICE

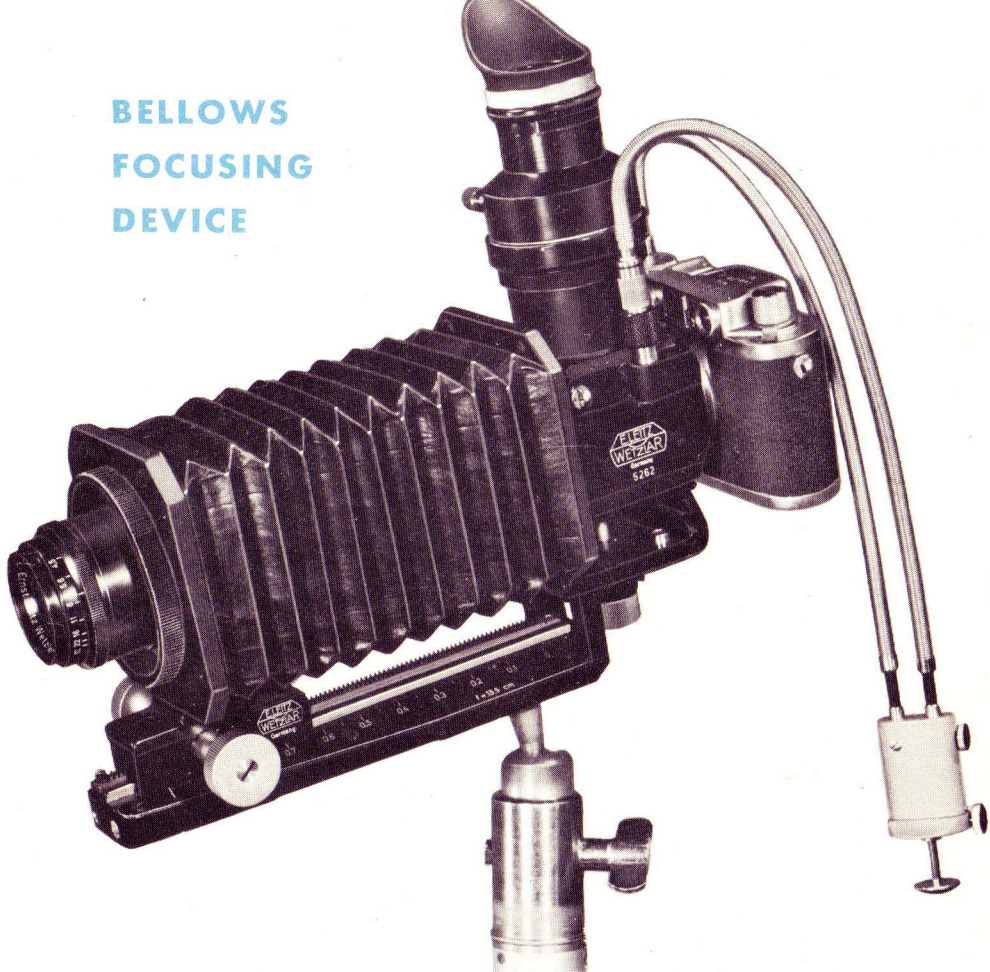

Figure 30. The Leica camera equipped with the Bellows Device.

Close-up and macro-photography have become daily tasks in technical and scientific work. They have also proved their worth in ophthalmic, dental and other types of medical photography. The amateur has found that taking pictures of small objects such as flowers, insects, stamps, etc., with their infinite variety of shapes, colors and forms . . . is an inexhaustible field.

**Near Focusing Devices** for the Leica, particularly the intermediate extension tubes which increase the distance between lens and camera, have fostered this development. Their only disadvantage was the time consumed in changing the extension tubes of various sizes so that the focusing distance could be changed quickly. This brought about the desire for a universal *continuous* method of focusing near-objects, which has now been achieved with the Bellows Focusing Device. It is intended primarily for the Leica camera with the Hektor 135mm. lens combined with the Mirror Reflex



Housing. This offers continuous focusing from infinity to a ratio of 1:1. The 135mm. lens will be found particularly advantageous for close-up work, as it provides a greater working distance at any given image size, with consequently more space to arrange lighting and in the case of medical photography, more comfort for the patient.

The Bellows Focusing Device offers the selective use of the mirror reflex housing or the special sliding focusing attachment. It provides a ground glass image with viewing magnifier, perfect control of image area, illumination and depth of focus up to the time of making the exposure. When using the Elmar 50mm. lens with the Mirror Reflex Housing, a magnification of 3.5x on the negative is possible. For photographing objects at shorter distances, 1:17 to 2.5:1 (area approximately 30x40cm.) a special Sliding Focusing Attachment must be used instead of the reflex housing. (*The domestic Focaslide will not work with the Bellows Focusing Device.*)

The Bellows Focusing Device can, with the aid of the special sliding focusing attachment, be adapted for copying books, magazines, etc., in a vertical position. It has a sturdy and precise rack and pinion motion on a dovetail slider. This provides smooth but definite motion, which permits extremely accurate and fine focusing. There are handy-grip knurled knobs for adjustment on both the right and left sides. Scales on the dovetail slider indicate the ratio of reproduction for the Hektor 135mm. lens on one side from infinity to 1:1 and the Elmar 50mm. lens on the other from 1:17 to 2.5:1.

Exposure factors are also indicated in red.

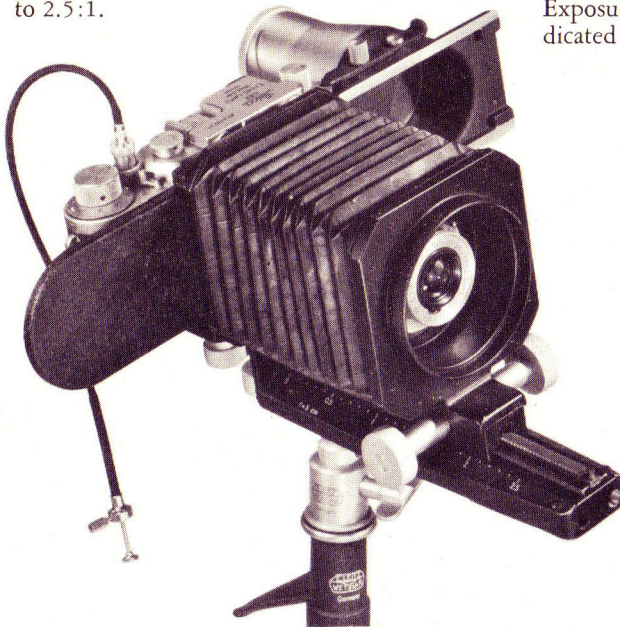

Figure 31. The Leica camera equipped with the Bellows Device, special Sliding Focusing Attachment, and Elmar 50mm. lens.

**Focusing:** Focusing is accomplished by observing the image on the ground glass of the special sliding focusing attachment or the reflex housing while racking the Bellows in or out. This should be done with the lens at full aperture, stopping down to the required opening when sharp focus has been obtained. It is desirable to use one of the magnifiers with the special sliding focusing attachment to assure critical focus, such as the 5x magnifier "lvfoo" or the 5x magnifier with 90° viewing angle "pamoo." The new magnifier "pegoo" with a magnification of 4x produces an erected image and one which is corrected from right to left, having particularly even distribution of light.

**Used with the Hektor 135mm. lens:** Different adapters are used for each of the lens combinations. This lens, designed for distance shots, is also particularly suitable for close-up work of small objects; the long working distance is very convenient for composing and illuminating the object. The versatility of this lens for long distance as well as close-up photography is only now being fully explored by using the Bellows Focusing Device.

The Hektor 135mm. objective has to be detached from either the regular or short focusing-mount. Remove the complete lens assembly from its focusing mount by unscrewing it and fasten it into the correct adapter. Screw the adapter into the front of the Bellows Attachment.



Figure 32. Removing the Hektor 135mm. lens assembly from the mount.

**Used with the Elmar 50mm. lens:** An interchangeable adapter ring with bayonet mount suitable for this lens is necessary. Remove the lens from the Leica and collapse it in its mount. Using the bayonet lugs on the rear of the lens, fasten it in the adapter. Screw the adapter into the front of the Bellows Attachment.

Place the special sliding focusing attachment on the base of the extension at the rear of the Bellows and fasten it with the tripod screw on the right side (when viewing from the rear), screwing it into the tripod socket on the right side of the special sliding focusing attachment.

Adjust the camera positioning bar of the special sliding focusing attachment and fasten the Leica to it as described under Focaslide instructions, Page 10.

**Exposure:** The mirror reflex housing, as well as the special sliding focusing attachment, is fastened to the bellows by a tripod screw. With the 135mm. lens focused at normal distances, the Bellows Focusing Device may be held in the hand, but when working close-up, and when using the 50mm. lens, it should be mounted on a tripod. A tripod socket is located in the base, and when used with the large ball-jointed tripod head, the unit may be turned through 90° permitting vertical pictures with the special sliding focusing attachment.



When making close-up pictures, the lens is extended further from the film than when photographing at normal distances and, therefore, requires an increase in exposure from the normal. The exposure increase necessary when using the 135mm. lens with the reflex housing, and the 50mm. lens with the special sliding focusing attachment is given in the accompanying table. When other combinations or lenses of other focal-lengths are employed, the exposure increase may be computed by using the formula:

$$T = \frac{D^2}{F^2}$$

T = Increase in exposure

D = Distance from center of lens to film plane

F = Focal-length of lens

TABLE IV — BELLOWS DEVICE EXPOSURE DATA

Image Size (Ratio)	Area Covered MM.	Depth of Field MM.				Distance from Object to Lens CM.		Exposure Factor
		f/5.6	f/8	f/11	f/16	Hektor 135 mm.	Elmar 50 mm.	
0.1	240 x360	41.1	58.7	80.7	117.3	147.3	56.1	1.2X
0.2	120 x180	11.2	16.0	22.0	32.0	79.8	30.3	1.4X
0.3	80 x120	5.4	7.7	10.6	15.4	57.3	21.7	1.7X
0.4	60 x 80	3.3	4.7	6.4	9.3	46.0	17.4	2.0X
0.5	48 x 72	2.2	3.2	4.4	6.4	39.3	14.8	2.3X
0.6	40 x 60	1.7	2.4	3.3	4.7	34.8	13.1	2.6X
0.7	34.3x 51.4	1.3	1.9	2.5	3.7	31.6	11.9	2.9X
0.8	30 x 45	1.1	1.5	2.1	3.0	29.2	11.0	3.2X
0.9	26.7x 40	0.9	1.3	1.7	2.5	27.3	10.3	3.6X
1.0	24 x 36	0.7	1.1	1.5	2.1	25.8	9.7	4.0X
1.5	16 x 24	0.4	0.6	0.8	1.2		8.0	6.3X
2.0	12 x 18	0.3	0.4	0.6	0.8		7.1	9.0X
2.5	9.6x 14.4	0.2	0.3	0.4	0.6		6.6	12.0X

## SUNSHADE

There is available, as an accessory, an adjustable sunshade of the bellows type similar to that used on motion picture cameras, as a sunshade for special effects in taking pictures against the light or for extreme short-range work where the photographic lights are close to the lens.

It is advisable, wherever possible, to use the adjustable sunshade as it eliminates all extraneous light and produces a crisper and more brilliant negative or color transparency.

The special sunshade is fitted to the bellows attachment by placing its two guide rods into the holes provided for them in the front of the rack and

Figure 33. The Leica camera equipped with the Bellows Device, Mirror Reflex Housing, Hektor 135mm. lens and sunshade.

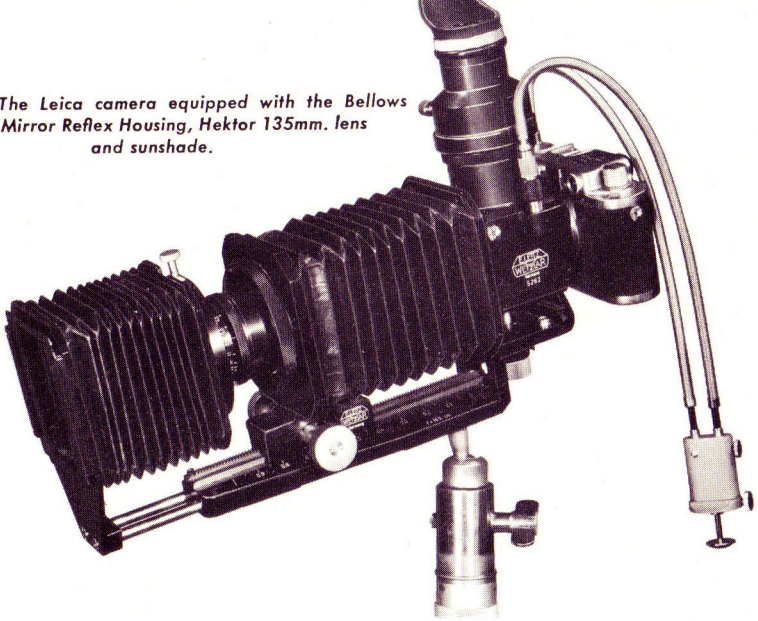

pinion base. When the 135mm. lens is in position, the inner ring of the sunshade bellows slips over the lens, and, when the 50mm. lens is in position, the outer ring of the sunshade bellows slips over the 50mm. adapter and is held by tightening the set screw.

The shade is adjusted to the desired length for maximum protection by sliding the guide bars in or out. The masking aperture plate, which fits in grooves at the front of the adjustable shade, is positioned vertically or horizontally, depending upon the type of picture being taken.

Figure 34. Excellent ophthalmic setup using Bellows Device and Mirror Reflex Housing. Office of Dr. Wayne Hull, Omaha, Nebr.

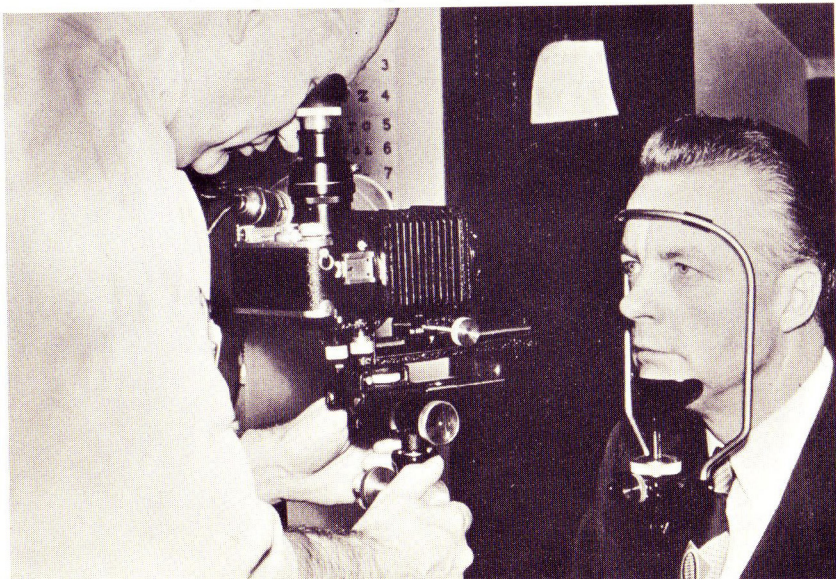



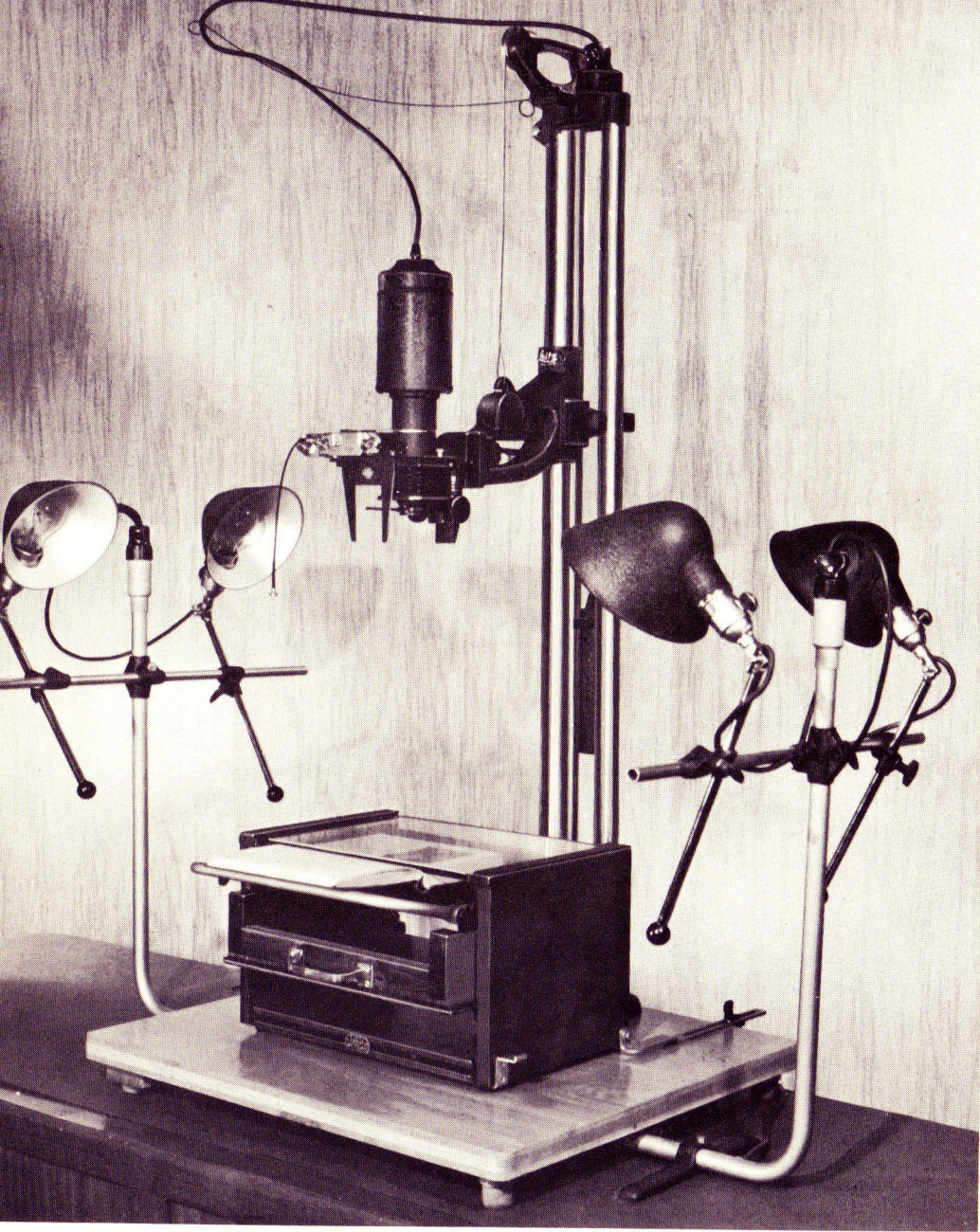

*Figure 35. Reprovit II for microfilming with the Leica.*



## MICROFILMING WITH THE LEICA REPROVIT II

The Reprovit II provides an easy, rapid means of microfilming with the Leica, accommodating material from 1" x 1.5" to 20" x 30". It consists of a baseboard, supporting uprights, special sliding copying attachment for the Leica, rack and pinion arrangement, illuminating equipment for lighting the copy and a special easel. It may be transported from one place to another, and is self-contained; simply plug it into a 110-volt A.C. or D.C. line.

**Baseboard:** The baseboard, supporting the complete unit, except the copying lights, measures 23" x 26" and is constructed of laminated, warp-resistant wood, set on thick rubber feet to absorb vibration. A two-way light switch is built into the base, and wiring connections are concealed beneath it. The constant level easel can be removed to place large work directly on the base.

**Upright Supports:** The large sturdy upright, paralleled by two smaller ones, fits into a casting mounted on the baseboard. This carries the clamping arm, copying head and the focusing light. The small upright serves as a guide for the counter-weight which connects to the clamping arm through a flexible cable. The third upright guides the arm by steel rollers, keeping it in perfect alignment at all times. The base of the uprights contains the main power switch.

**Clamping Arm:** The clamping arm holds the copying head. A small built-in finger release securely locks the arm in any desired position. A spring-wound steel tape, housed in the arm is used for measuring the distance to the material to be copied. A round bracket is located on the arm to hold the focusing light when not in position on the copying attachment.

**Copying Head:** The detachable copying head consists of a focusing light, sliding copying attachment, adjustable bellows with rack and pinion, a special 50mm., f/3.5 coated Elmar lens in rigid mount with click stops and automatic diaphragm setting arrangement, and a second rack and pinion for fine adjustment. It also contains a scale which shows at a glance the ratio at which the reproduction is made and the exposure factor. The head is fastened to the clamping arm by a sturdy tripod screw and may be removed for field use. The diaphragm setting arrangement may also be removed when used in the field and photographs may be taken at distances from infinity to 1:1.

The focusing light is a tubular, well-ventilated housing, from which the top may be removed to replace a special 100-watt projection bulb; the lower end of the housing contains a multi-element condensing system. Electrical connections for the focusing light are made by means of a plug which fits into a receptacle at the top of the upright column. A spring wire, extending from the top of the column, keeps the cord from interfering with the operation of the equipment.

The light fits over the ground glass of the sliding copying attachment by means of bayonet lugs. When the light is on an illuminated area, the size to



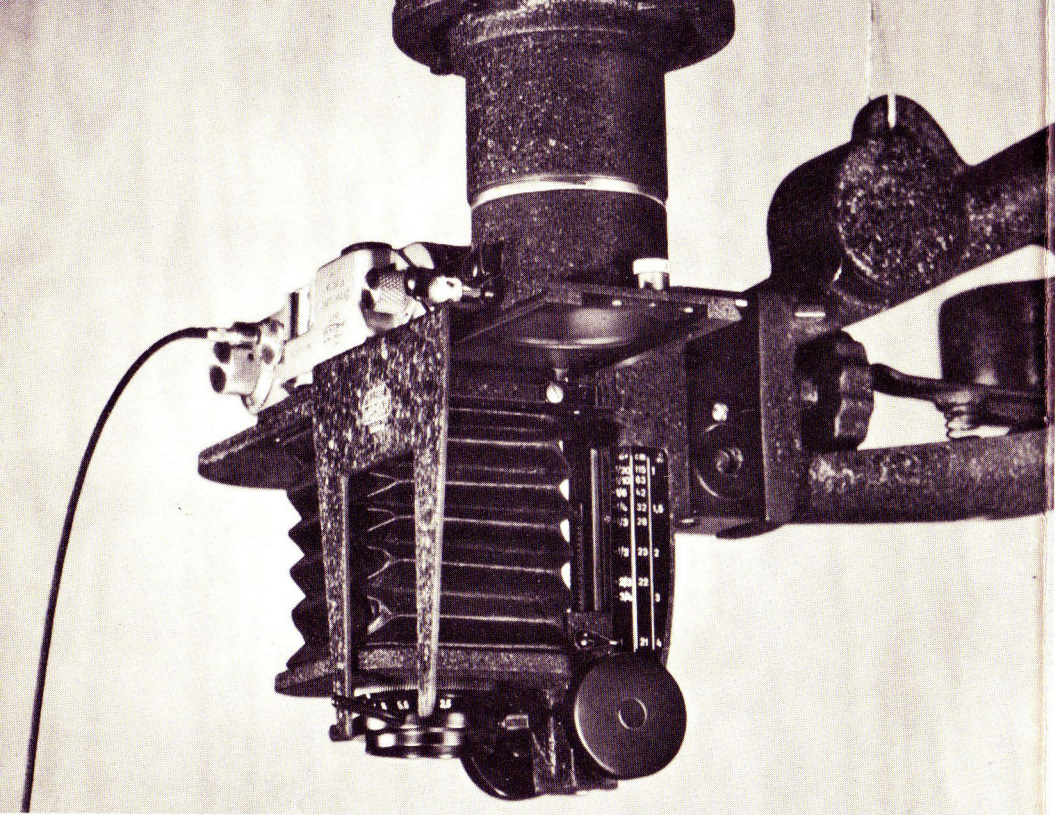

Figure 36. Copying head showing automatic diaphragm setting control and focusing light.

be photographed is projected onto the easel or baseboard, together with a focusing pattern.

**Focusing:** When photographing flat objects, focusing is simplicity itself. Turn on the power with the switch located in the base of the uprights, and move the baseboard switch forward. Place the sliding plate in the left position so that the ground glass screen is over the lens and fasten the focusing light over the ground glass.

Raise or lower the copying head on its upright by releasing the finger clamp until the desired area to be photographed is projected. Using the front rack and pinion, adjust the bellows until the projected pattern is sharp. Gross changes in distance are made by moving the clamping arm, whereas, minor variations are made with the rear rack and pinion.

When the projected image is correctly focused, the material being photographed will be in sharp focus with the camera in position. If it is desired to make a photograph at a predetermined ratio, determine the distance necessary from the scale and, holding the tape measure to the copy by its weight, move the copying head on the upright until the correct distance is noted, then focus the projected focusing pattern.

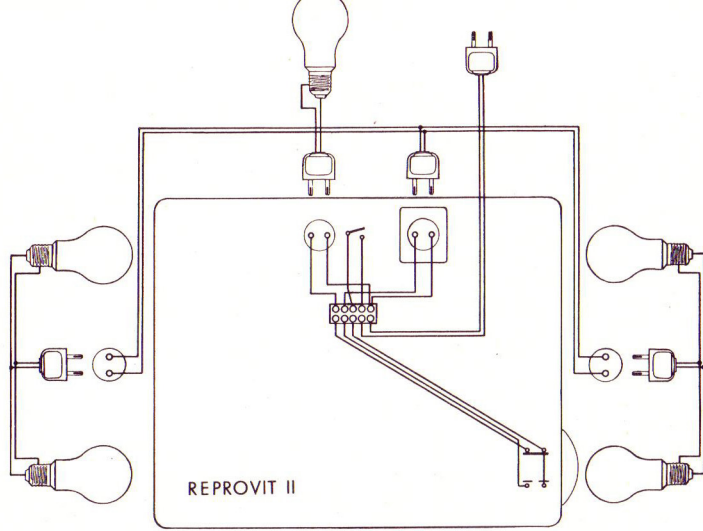

Figure 37. Wiring diagram of Reprovit II.

To avoid accidental movement of the sliding plate when focusing, lock it in position by pushing the slotted locking plate to the rear.

**Lights:** Place the stand holding the copy lights under the baseboard, centering it, and adjust the feet until the tubes holding the lights are upright.

Plug the double cords from the lamps into the proper socket on top of the tubular uprights, and adjust the individual lamps so they are evenly spaced. The plug with double cord running from the base of the lights should be plugged into the receptacle on the baseboard. Plug the single cord running from the baseboard into any 110-volt line, and turn on the main power switch located in the base of the upright columns. Throw the switch, on the under left side of the baseboard, to the rear. If all four copy lights are not burning, turn them on by the individual socket switch. Adjust the cross arms and each individual lamp until the illumination on the easel or baseboard is even. The best position for the lights, to avoid reflection, is at an angle of  $45^\circ$  to the material being photographed.

**Easel:** Small sheets, books and copy that tend to curl should be placed in the special easel. Pull the drawer out half way and place the material to be copied between the platform and glass top. When the drawer is pushed in, the copy will be held flat against the glass. If the material is too thick to rest between the platform and glass with the drawer half way out, take out the drawer and put it in one of the lower grooves. The easel may be fastened to the baseboard by the clamping bars with slot and wing nuts to the rear and beneath the baseboard. Make certain the glass top of the easel is clean and dust free. Adjust the arm of the lower platform to hold that portion of the copy which may extend beyond the glass top. (If a number of exposures are to be made without refocusing, it is advisable to lock the sliding plate in position by turning down the locking arm located on the right edge of the lower plate of the sliding attachment.)



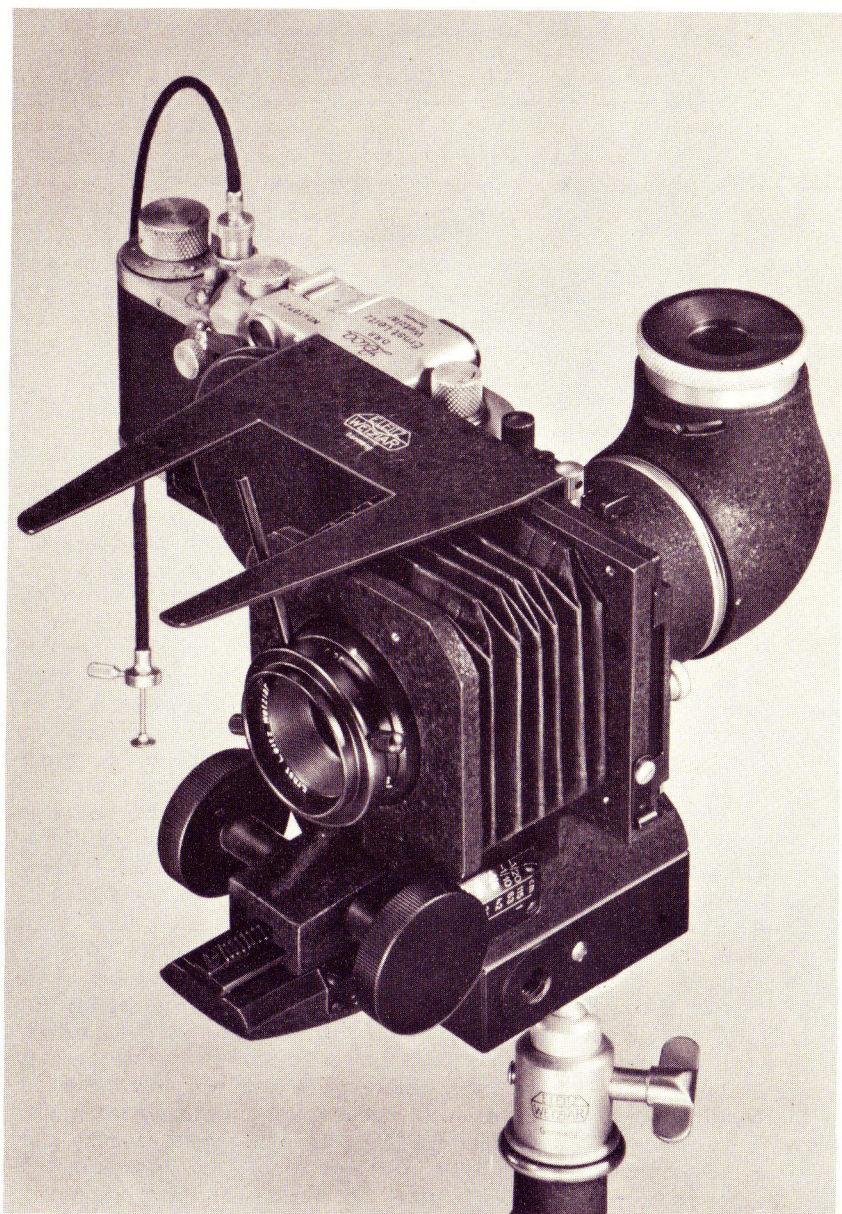

Figure 38. The Leica camera with the special Sliding Focusing Attachment and Reprovit Bellows for field use.



Correct exposure is determined by an exposure meter and noting the exposure factor indicated on the rack and pinion scale. It is good practice to use a cable release to avoid motion.

**Field Use:** The Reprovit II is not limited to microfilming. The pathologist will find it most convenient for photographing gross specimens, and the industrialist will use it for photographing small models, tools and machine parts. Focusing under these conditions can be carried out by observing the image on the ground glass, or by projection, selecting a mid-place on the subject for sharp focus of the projected pattern.

For field use, remove the focusing light and store it in its bracket; then remove the copying head from the clamping arm by unfastening the tripod screw. The image is viewed on the ground glass while focusing with the rack and pinion, and for critical results, one of the magnifiers designed for the Focaslides should be used. The clear central spot on the ground glass screen permits the use of the 30x magnifier.

For use in the field, it may be more convenient to remove the automatic diaphragm stop from the copying head. The forked adjusting plate can be taken off the sliding attachment by loosening the knurled screw on the ground glass housing and sliding the plate to the left. The diaphragm setting ring is removed by loosening the knurled screws.

**Sliding Copying Attachment:** Remove the lens from the Leica and fasten it to the special Sliding Focusing Attachment. Set the slotted locking bar on the right edge of the sliding plate to its central stop; then the plate is free to move to the right. (The locking lever on the right end of the lower stationary plate should be parallel with the end of the plate.)

The sliding copying attachment which holds the Leica and provides a means of visual focusing is similar to the Focaslides; however, the two are not interchangeable.

**Automatic Diaphragm Stop:** It is desirable to focus with the lens at full aperture and then stop down before making the exposure. This change in diaphragm setting is automatic in the Reprovit II. Push the sliding plate of the Sliding Focusing Attachment to the left, set the ground glass screen in position over the lens, and set the lens at  $f/3.5$ . Fit the clamping ring with long pin on the diaphragm ring of the lens. Rest the pin against the right fork of the adjusting plate and tighten the two knurled screws. Push the sliding plate to the right, bring the camera into position over the lens, and the left fork of the adjusting plate engages the pin of the clamping ring closing the diaphragm to  $f/11$ .

**Making the Exposure:** After correct framing and focus has been attained, extinguish the focusing light by means of the base switch and illuminate the copy; then slide the camera into position over the lens.

Leica lenses cannot be used on the copying head, and a sunshade cannot be used with the special 50mm. lens, as it is deep-seated in its mount.





Leitz





E. LEITZ INC.

304 HUDSON STREET

NEW YORK 13, N. Y.