

# WILSONWERKS ARCHIVES

This camera manual is for reference and historical purposes, all rights reserved.

This cover page is copyrighted material. This document may not be sold or distributed without the express consent of the publisher.

©2008 wilsonwerks Llc

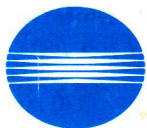

MINOLTA

# X-370

OWNER'S MANUAL

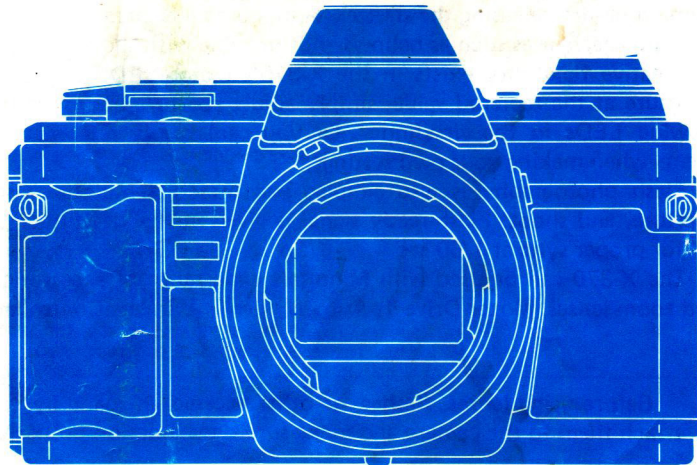

Your Minolta X-370 is an easy-to-use microcomputerized single-lens-reflex (SLR) camera with quartz control of mechanical sequences and shutter speed, providing lasting accuracy and years of enjoyment.

In its aperture-priority auto-exposure (AE) mode ("AUTO" on the camera), the X-370 automatically sets the precise shutter speed for correct exposure according to the in-camera meter at the aperture you selected. An AE lock can be used to hold a meter reading and then readjust the framing before releasing the shutter. Auto control is maintained even when using mirror lenses and close-up accessories such as bellows—not possible with shutter-priority AE systems.

Creative flexibility exists in the X-370's match-LED/full-metered manual mode: For correct exposure at the metered value, simply adjust aperture and/or shutter speed to align blinking and glowing LEDs in the viewfinder. Or you can merely refer to these LEDs—or totally disregard them—when making your own settings.

Flash photography is also simple: just attach a Minolta X-series Auto Electroflash, adjust aperture, and shoot. Flash-ready signal is given in the viewfinder, and the shutter is automatically set for proper sync at 1/60 sec.

The X-370 can be used with Minolta's wide range of accessories, such as wideangle, telephoto, and zoom lenses, Motor Drive 1, Auto Winder G, Wireless Controller IR-1, and much more.

Before using lenses, flashes, or other accessories made by companies other than Minolta, attach them to the camera and make sure they function properly by taking test photographs.

## CONTENTS

<b>NAMES OF PARTS</b> . . . . .	2	<b>CREATIVE CONTROL</b> . . . . .	24
<b>STRAP AND CASE</b> . . . . .	5	<b>AE LOCK</b> . . . . .	24
<b>SUMMARY OF OPERATION (auto mode)</b> . . . . .	6	<b>MANUAL EXPOSURE MODE</b> . . . . .	26
<b>PREPARING TO TAKE PICTURES</b> . . . . .	8	Long exposure at "B" setting . . . . .	27
<b>ATTACHING AND REMOVING LENS</b> . . . . .	8	<b>DEPTH OF FIELD</b> . . . . .	28
<b>BATTERIES AND POWER</b> . . . . .	9	<b>SHUTTER SPEED</b> . . . . .	29
Battery check . . . . .	11	<b>OTHER FOCUSING METHODS</b> . . . . .	30
Cold-weather operation . . . . .	11	Distance scale . . . . .	30
<b>FILM AND FILM SPEED</b> . . . . .	12	Infrared index . . . . .	30
<b>LOADING FILM</b> . . . . .	13	Film-plane index . . . . .	30
Safe Load Signal/Frame counter . . . . .	15	<b>FLASH PHOTOGRAPHY</b> . . . . .	31
<b>VIEWFINDER</b> . . . . .	16	<b>ACCESSORIES</b> . . . . .	32
<b>PRESHOOTING CHECK</b> . . . . .	17	<b>TECHNICAL DETAILS</b> . . . . .	34
<b>TAKING PICTURES IN AUTO MODE</b> . . . . .	18	<b>CARE AND STORAGE</b> . . . . .	36
<b>CAMERA SETTINGS</b> . . . . .	18		
<b>FOCUSING</b> . . . . .	20		
<b>HOLDING CAMERA AND RELEASING</b>			
<b>SHUTTER</b> . . . . .	21		
Mounting camera on tripod . . . . .	22		
Self-timer . . . . .	22		
Eyepiece cap . . . . .	22		
<b>REWINDING AND UNLOADING FILM</b> . . . . .	23		



## NAMES OF PARTS

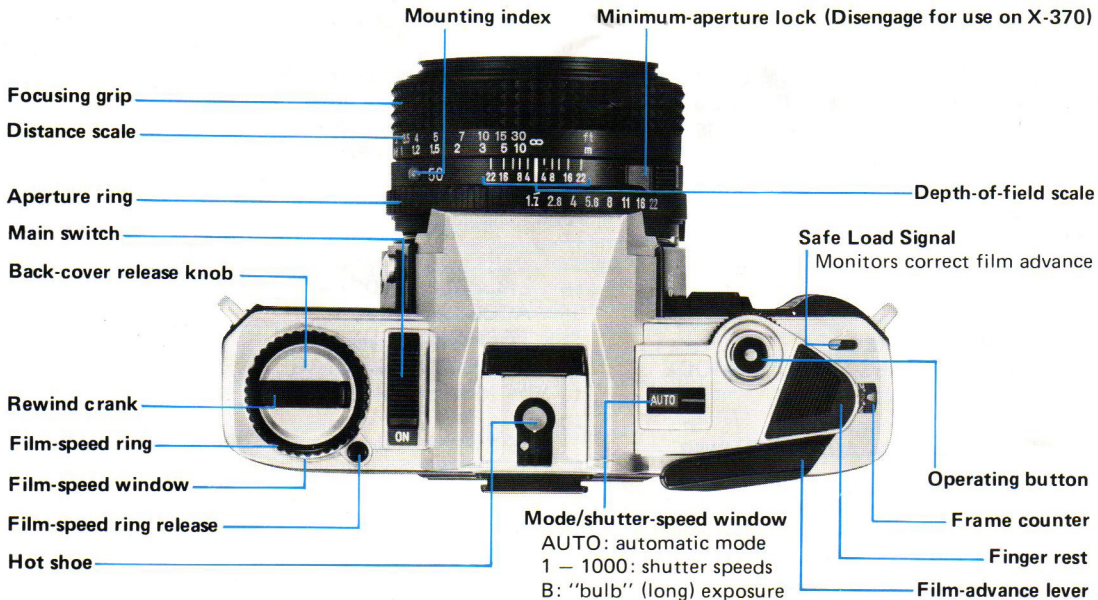

**AE lock/self-timer switch**

- AE lock for holding close-up or adjusted-viewing meter readings
- Self-timer with triple-rate blinking LED

**Mode/shutter-speed selector**

**Self-timer LED**

**Front grip**

**Bayonet lens mount**

**MC coupler**

**Lens-mounting index**

**Lens-release button**

**Shutter-release socket**

**Mirror**

**Diaphragm-control lever**

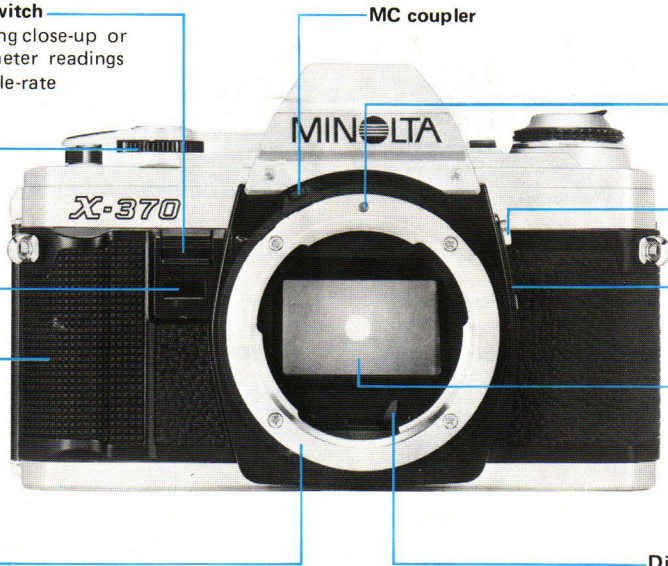

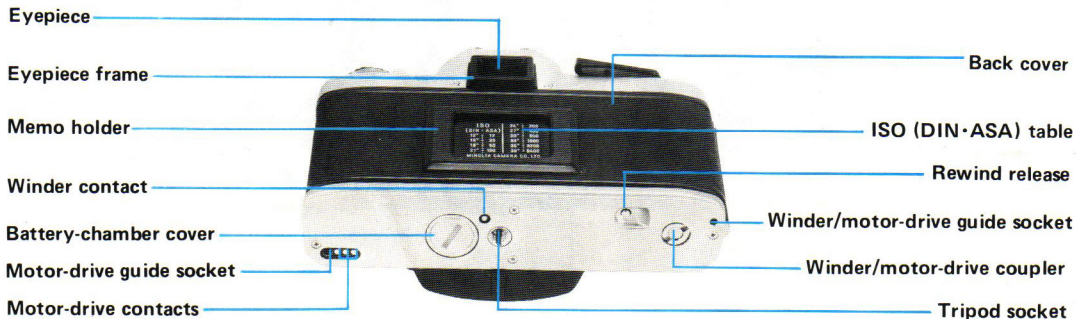
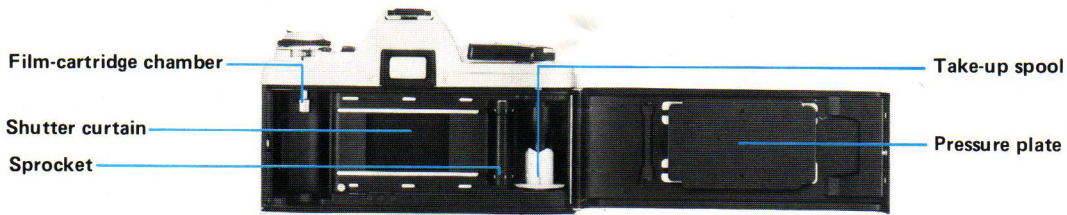

## STRAP AND CASE

Attach the strap (provided) and case (optional) as shown. The strap includes a battery holder used for storing fresh spare batteries.

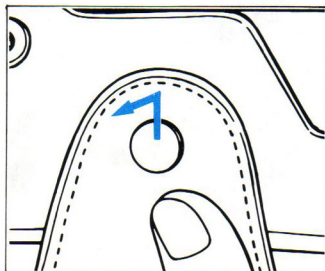
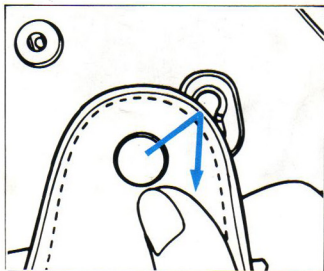
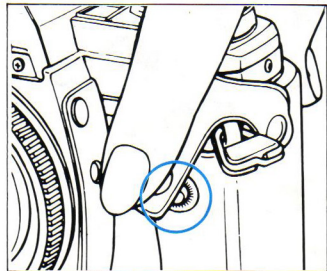
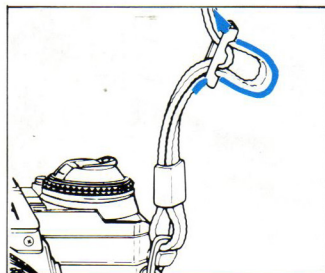
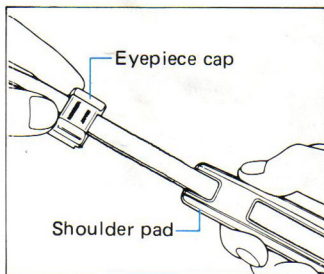
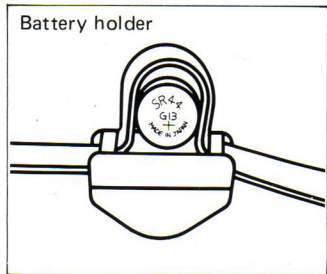

## SUMMARY OF OPERATION (Automatic mode)

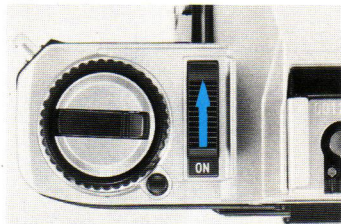

1. Slide main switch to "ON"  
(p. 10).

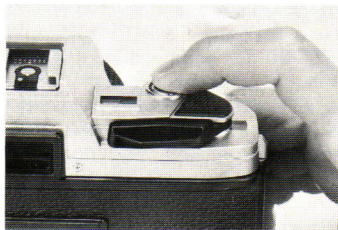

2. Check battery power  
(p. 11).



3. Set film speed (p. 12).

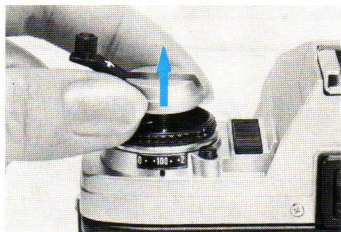

4. Open back cover (p. 13).

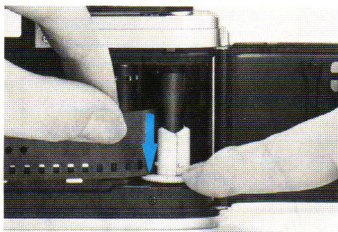

5. Load film properly and  
close cover (p. 14).

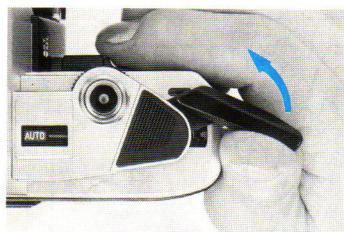

6. Advance film to frame "1"  
and check Safe Load Signal  
(p. 15).





7. Set mode/shutter-speed selector to "AUTO" (p. 18).



8. Select lens aperture (p. 19).



9. Adjust focus (p. 20).



10. Release shutter (p. 21).

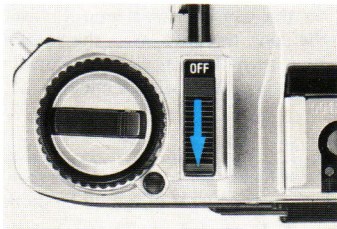

11. Slide main switch to "OFF".

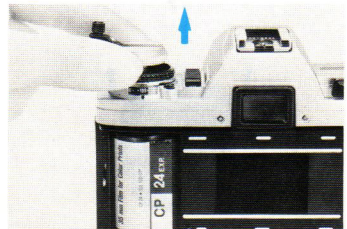

12. Rewind and remove film (p. 23).



## PREPARING TO TAKE PICTURES

### ATTACHING AND REMOVING LENS

#### Body and lens caps

Remove body and lens caps as shown.



#### To attach

Align the red mounting index on the lens barrel with the red index on the camera's lens mount. Insert the lens bayonet into the mount, then turn the lens clockwise until it locks into place with a click.



#### To remove

While pressing the lens-release button, turn the lens counterclockwise as far as it will go, then lift it out of the mount.

- Never set a lens with its rear end down unless a rear lens cap is on, or its control pins may be damaged.
- Be careful not to touch anything inside the camera, especially the mirror, when attaching or removing lenses.

## BATTERIES AND POWER

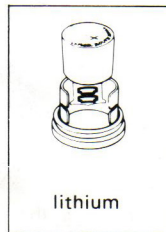
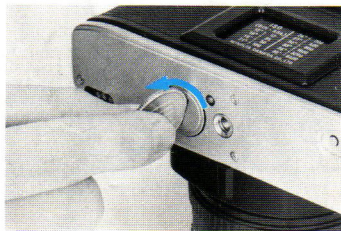
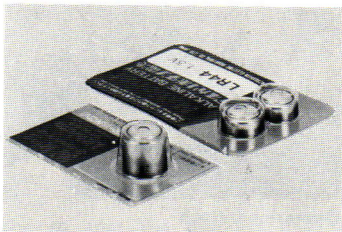

### Batteries

Use one of the following types of batteries:

- Two 1.55v silver-oxide (SR-44: Eveready S-76, EPX-76, or equiv.)
- Two 1.5v alkaline-manganese (LR44: Eveready A-76 or equiv.)
- One 3v lithium (CR-1/3N)

1. Using a coin or similar object, unscrew the battery-chamber cover counterclockwise and remove it.

2. Wipe the terminals with a clean, dry cloth. Hold the batteries by their edges and insert them plus (+) side up into the sleeve on the inside of the cover.

- Do not use 1.35v mercury batteries (MR44: Eveready EPX-675 or equiv.), which are the same shape and size, because their voltage is too low.
- To avoid battery leakage or bursting, do not mix batteries of different types, brands, or ages.
- Keep batteries away from young children.



3. Replace the cover and screw it in clockwise as far as it will go.

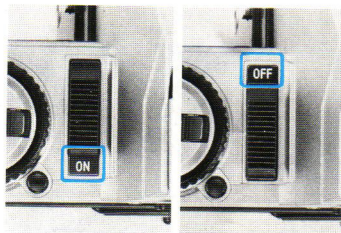

#### Main switch

To operate the camera, slide the main switch to "ON".

When you have finished taking pictures, move the main switch to "OFF" to prevent accidental exposures and battery drain. (If the switch is left on, however, battery drain occurs only when the operating button is touched, so you may want to leave it on to avoid missing unexpected shots.)

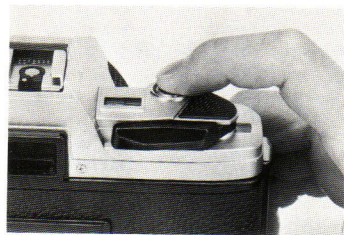

#### Operating button

Touching the operation button (with the main switch on) activates the camera's meter, viewfinder LED display, and exposure-control system. If proper contact is not possible (e.g., when wearing gloves), press the operating button slightly. The shutter is released when the button is pressed all the way down.

The viewfinder LED display will remain on for 15 sec. after you remove your finger.

A	-A-	
1000	1000	1000
500	500	500
250	250	250
125	125	125
60	60	60
okay	prepare spares	replace

### Battery check

The camera automatically checks battery power when the operating button is touched or pressed.

- When batteries are nearly exhausted, the mode LED ("A" or "M") in the viewfinder blinks to warn that fresh batteries will soon be needed.
- When batteries are completely exhausted (or not correctly installed), no LEDs light and the shutter locks.

### Cold-weather operation

Since batteries tend to lose power as temperature drops, always use fresh batteries when photographing in cold weather and keep a spare set with you, preferably in a warm pocket close to your body. Battery capacity will be restored when temperature returns to normal.

For prolonged cold-weather use at approx. 0°C (32°F) or lower, it is recommended to use silver-oxide batteries; if a lithium battery is used below approx. 0°C (32°F), the camera may not operate.

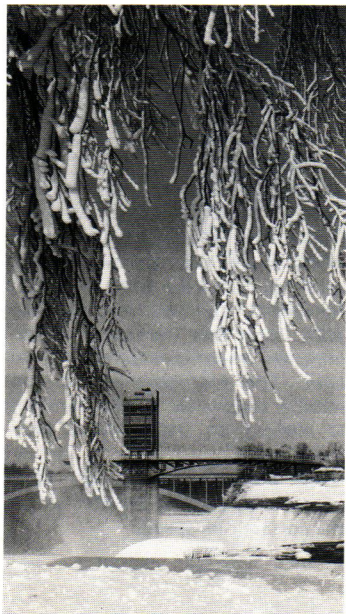



## FILM AND FILM SPEED

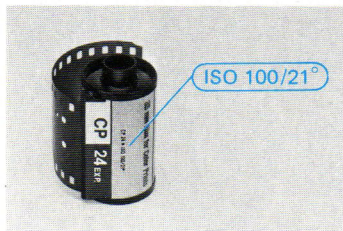

The camera uses standard 35mm cartridge film. Each film has an ISO film-speed number (incorporating ASA and DIN numbers) which indicates the film's sensitivity to light. The first part of the ISO number (equivalent to ASA number) is marked on the camera's film-speed ring.

For proper exposure, the camera's film-speed ring must be set to the correct film speed.

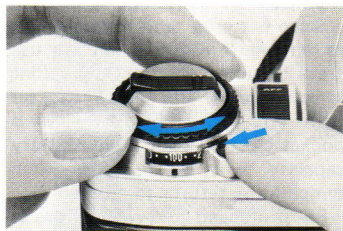

### Setting film speed

While pressing the film-speed ring release, turn the film-speed ring until the desired number lines up with the index and locks in place when you remove your finger from the release.



### Memo holder

An ISO (DIN•ASA) table is located on the camera back. It is surrounded by a handy memo holder where you can insert the film box end as a reminder of the film type in use.

### Intermediate settings and DIN equivalents

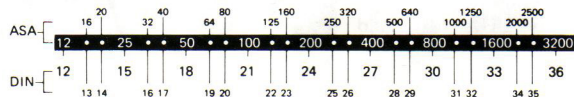

## LOADING FILM

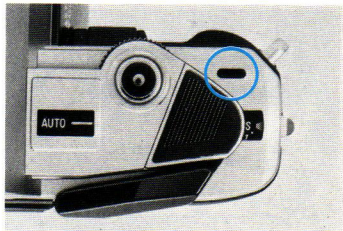

Before opening the camera back, make sure there is no film inside the camera by checking the Safe Load Signal (p. 15).

### NOTE

- When loading film in a dark place or with the lens cap on, loading will be easier if the mode selector is not set at "AUTO".

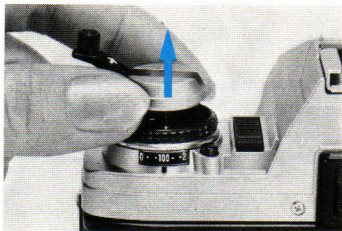

1. Unfold the rewind crank and pull up on it to lift the back-cover release knob. Pull up on the knob until the camera back springs open.

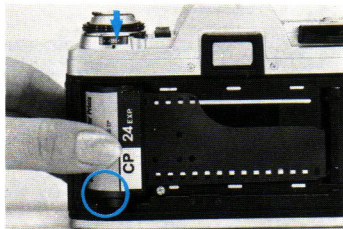

2. Leaving the knob pulled out, position a 35mm film cartridge in the chamber with its projecting spool down. Then push the back-cover release knob all the way in, rotating it slightly if necessary.

- Always handle and load film in subdued light—at least shaded from direct light by your body.

- Do not touch any parts or areas inside the camera shown in blue.

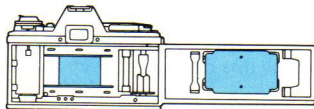



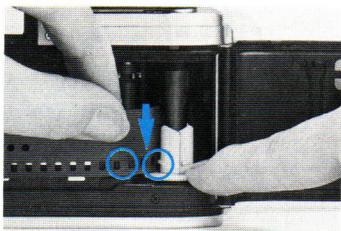

**3.** Pull out just enough film leader to reach the take-up spool. Insert the end of the film into a slot on the left side of the take-up spool, making sure that a hole in the film is lined up with the tooth on the take-up spool. The sprocket teeth should be engaged with holes at the bottom of the film.

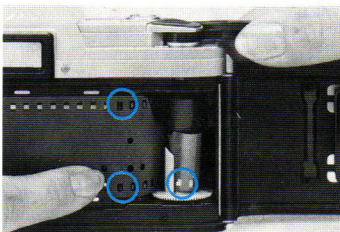

**4.** With the film held against the sprocket by your left hand, slowly operate the film-advance lever until the film is wound firmly around the take-up spool, the sprocket teeth are engaged with holes on both edges of the film, and the slack in the film is taken up. If the film-advance lever stops at the end of a full stroke during this procedure, release the shutter and continue (main switch must be on).

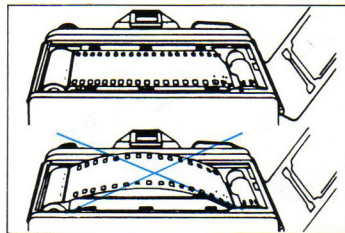

**5.** After making sure that the film is taut, close the camera back by pressing it until it locks shut with a click. A red "S" should now appear opposite the index in the frame counter.

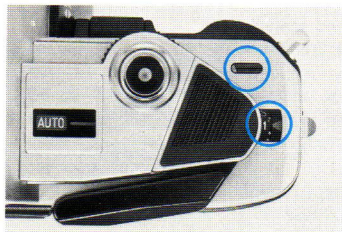

6. Advance the film and release the shutter until the index points to "1". A red bar should appear at the far left in the Safe Load Signal indicating that film is loaded and advancing properly. If it does not appear or swings far to the right, repeat steps 3 to 6.

The camera is now ready for taking the first picture, provided film speed is set.

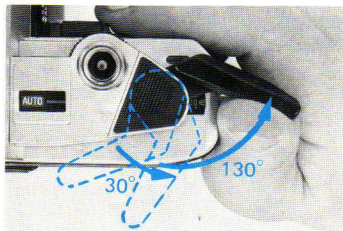

#### Film-advance lever

The lever has  $30^\circ$  of unengaged movement to allow swinging it out from the camera body so the right thumb will fit comfortably behind it. As the lever is moved an additional  $130^\circ$  until it stops, the film and frame counter advance and the shutter is cocked for the next exposure.

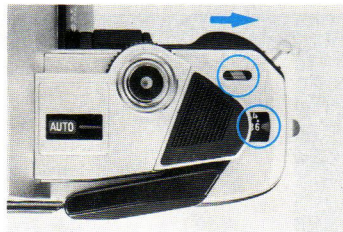

#### Safe Load Signal/Frame counter

As you take pictures and advance the film, the red bar in the Safe Load Signal gradually moves to the right and the rewind crank rotates counterclockwise, indicating proper film advance.

Never force the film-advance lever when it stops and resists further movement at the end of the film, which may be somewhat before or after the common film lengths (12, 20, 24, 36 exposures) shown in red in the frame counter. The frame counter stops advancing after 36 exposures.

## VIEWFINDER

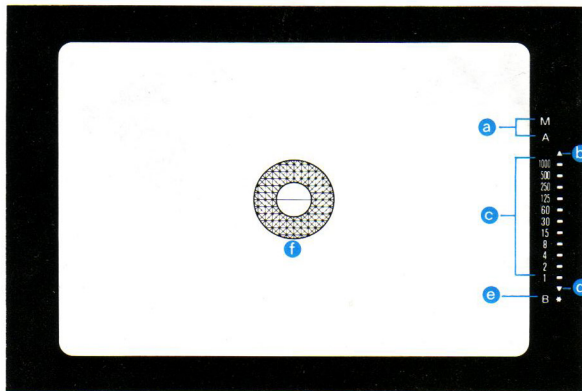

**a Mode indicators**

M: Manual mode  
A: Auto mode

**b Over-range LED**

Blinks at 4Hz (4 times per second)

**c Shutter-speed scale/LEDs**

- Glowing LED(s) indicate: (1) in "A" (auto) mode, shutter speed set by camera (if two LEDs glow, camera sets stepless speed between the two), and (2) in "M" (manual) mode, the metered speed
- Blinking LED (at 4Hz) indicates user-set shutter speed in manual mode
- "60" LED blinks at 2Hz as flash-ready signal with X-series Minolta Auto Electro-flashes

**d 1 – 4 sec./under-range LED**

- Glows if metered speed is between 1 and 4 sec.
- Blinks (at 4Hz) if outside range

**e B-setting indicator**

**f Focusing screen**

Split-image spot, microprism band, and Acute Matte field

## PRESHOOTING CHECK

Check the following items to make sure your camera is ready for picture-taking:

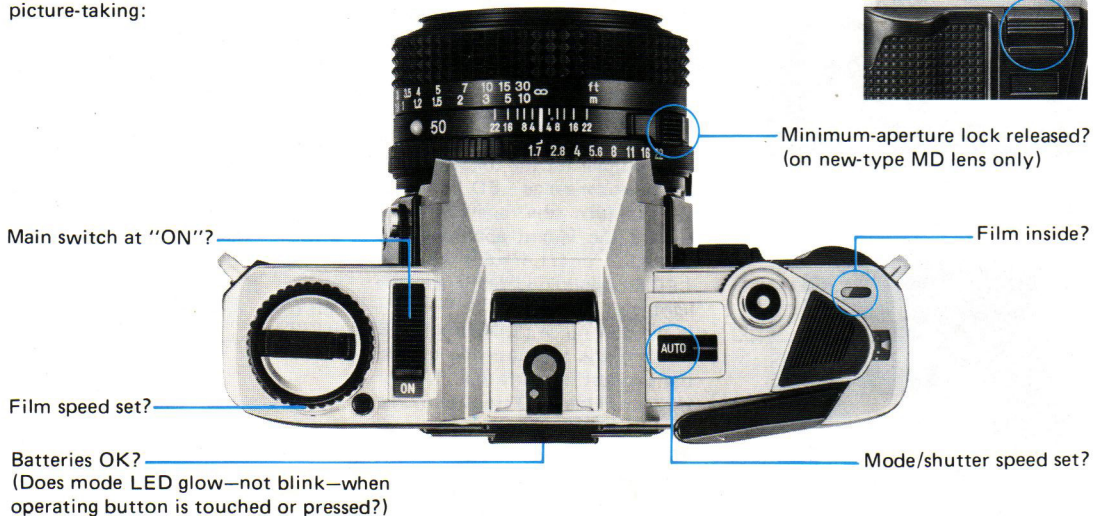

## TAKING PICTURES IN AUTO MODE

### CAMERA SETTINGS

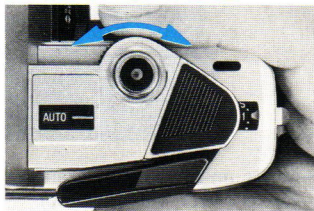

Set mode/shutter-speed selector to "AUTO".



Set lens at desired aperture.

In aperture-priority auto mode, all you need to do is set the desired aperture—the camera will automatically select the shutter speed needed for proper exposure.

#### Viewfinder display

Before releasing the shutter, compose your picture, focus, and check the viewfinder for the following:

- Is the under-range LED blinking? If so, turn the aperture ring toward the largest aperture (i.e.,  $f/2$ ,  $f/1.7$ , or  $f/1.4$ , etc.) until the LED stops blinking, or increase the light level if possible.
- Is the over-range LED blinking? If so, turn the aperture ring toward the smallest aperture (i.e.,  $f/16$  or  $f/22$ ) until the LED stops blinking. If it does not stop, use a neutral-density (ND) filter, or reduce the light level if possible.
- Is an LED on indicating  $1/30$  sec. or slower shutter speed? Using slow shutter speeds may result in

blurred pictures due to camera movement. To correct, turn the aperture ring toward the largest aperture (i.e.,  $f/1.7$ ,  $f/1.4$ , etc.) until the  $1/60$  sec. LED lights. If not possible, use a tripod (p. 22) or flash (p. 31).

#### NOTE

- In some situations you should use the AE lock (p. 24)
- If your head is not shielding the eyepiece from light when the picture is taken (as when using self-timer or a cable release), attach the eyepiece cap (p. 22)







### Selecting aperture

In auto mode, your camera will automatically set the precise shutter speed for proper exposure at the set aperture. Even so, you have considerable control over results and can adjust aperture and shutter speed over sizable ranges.

For good pictures where no particular effect is desired, simply set the aperture as indicated in the table. These settings will provide as much depth of field as possible while producing a shutter speed fast enough to stop the motion of most subjects.

There may be times, however, when you want to obtain a particular effect, such as rendering a certain range in sharp focus, emphasizing a subject against an out-of-focus background, or selecting a specific shutter speed. In these cases, you must select the appropriate aperture to give the desired depth of field (see p. 28) or the desired shutter speed (p. 29).

### Guidelines for typical picture-taking situations

ISO	Sunny	Hazy Sun	Heavy Over-cast	Indoors
				
25/15°	f/8	f/4	f/2	f/1.4
64/19°	f/8	f/4	f/2.8	f/1.4
100/21°	f/11	f/5.6	f/4	f/1.4
160/23°	f/11	f/8	f/5.6	f/2
200/24°	f/11	f/8	f/5.6	f/2
400/27°	f/16	f/11	f/8	f/2.8
1000/31°	f/22	f/16	f/11	f/4



## FOCUSING

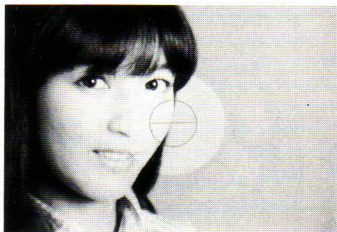

In focus



Out of focus

The camera's focusing screen has a focusing aid consisting of a split-image spot surrounded by a band of microprisms in the center of an Acute Matte field.

To focus the camera visually, look through the viewfinder and turn the lens' focusing grip until:

- Upper and lower subject images in the spot are exactly aligned with no broken lines between them.
- Subject image in the band does not shimmer or appear broken up.

At this point, the subject image within the viewfinder's center focusing aid appears clearest and seems to blend with that on the matte field surrounding it.

You will probably find that focusing is easiest if:

- Split-image spot is used for subjects having vertical lines.

- Microprism band is used for lenses from medium wideangle through medium telephoto, especially with subjects not having vertical lines.
- Matte field is used for longer focal-length lenses or for macro or other work involving considerable lens extension.

## HOLDING CAMERA AND RELEASING SHUTTER

Holding the camera as shown lets you operate most controls while viewing through the camera's eyepiece.



### LEFT HAND

- Thumb: focusing grip, aperture ring
- Index: focusing grip
- Middle: aperture ring

### RIGHT HAND

- Thumb: film-advance lever
- Index: mode/shutter-speed selector or operating button
- Middle: AE lock



To obtain sharp, blur-free photos, hold the camera as still as possible and press the operating button gently to release the shutter. The camera should be steadied against your face or body. Always press the button with a slow, steady squeeze to release the shutter—never a quick jab.

Some ways of holding the camera are shown here. If you grasp the camera firmly with your right hand on its front grip, you can shift it



back and forth for horizontal **(a)** and vertical **(b)** pictures without removing your hand from its controls. By cradling the camera in your left hand, you can easily focus and set the aperture, then shoot. Photo **(c)** shows an alternative for holding the camera vertically.



### Mounting camera on tripod

For maximum sharpness when making exposures too long to permit handholding of the camera (1/30 sec. or slower), mount the camera on a tripod using the socket on the camera bottom.

Screw the Remote Cord into the shutter release socket and release the shutter.

- Do not use excessive force when attaching the camera to a tripod.
- The mounting screw should be 5.4mm (1/4 in.) or shorter.

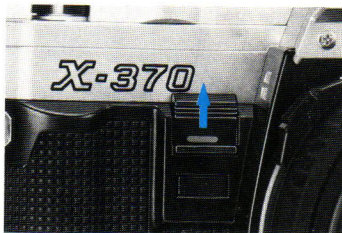

### Self-timer

The camera's electronic self-timer can be used to delay shutter release for 10 sec.

1. Mount the camera on a sturdy support (such as a tripod), compose your picture, and focus.
2. Set the mode/shutter-speed selector at any setting other than "B", and make sure that the film is advanced.
3. Pull the self-timer switch up.
4. To start the timer, press the operating button.

A visual signal will indicate how much time is left before the self-timer releases the shutter.

Self-timer LED blinks as follows:  
 First 8 sec.: twice per sec.  
 Next sec.: eight times per sec.  
 Last sec.: continuously

### NOTE

- You may cancel the self-timer after it has been started by pushing the self-timer switch down or by sliding the main switch to "OFF".
- After taking the picture, switch off the self-timer, or the next picture will be taken after a 10-sec. delay.

### Eyepiece cap

When using the camera in auto mode or at "B" and your head does not shield the eyepiece from light (self-timer operation or Remote Cable release), slide the eyepiece cap onto the eyepiece frame. This prevents unwanted light from affecting exposure.

To keep it handy, the eyepiece cap threads onto the camera strap.

## REWINDING AND UNLOADING FILM

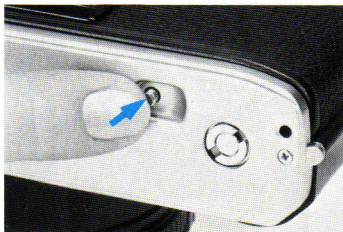

1. Press the rewind release on the camera bottom.



2. Unfold the rewind crank and turn it in the direction of the arrow until the red bar in the Safe Load Signal moves out of the window to the left. Near the end, you will feel tension of the film increase then completely disappear, and the crank will then turn freely.

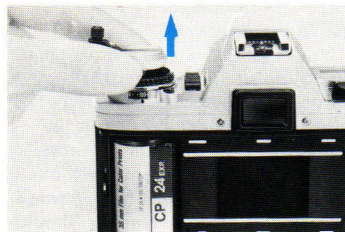

3. When you are certain that the exposed film is completely rewound into the cartridge, pull up on the back-cover release knob to open the back, then remove the film cartridge.

- Never open the camera back when there is any red still visible in the Safe Load Signal.



## CREATIVE CONTROL

### AE LOCK

#### When to use

Your X-370's center-weighted averaging meter system is designed so that light from all parts of the viewfinder is measured, but influence from a large central area is greatest. Thus, when the main subject fills most of the frame's center, the meter reading should give satisfactory exposure. However, when there is a great brightness difference between the subject and background where the main subject does not fill the center of the frame, the AE lock should be used (with camera in auto mode).

Use the AE lock in situations where subjects appear dark against strong backlighting, such as windows, or against a light background of snow or sand; or where subjects appear very light against a dark background, as when standing in a spotlight or shaft of sunlight.



#### How to use

To obtain proper exposure in high-contrast lighting situations where your subject is on the edge of the frame or occupies only a small portion in the center, use the AE lock as follows:

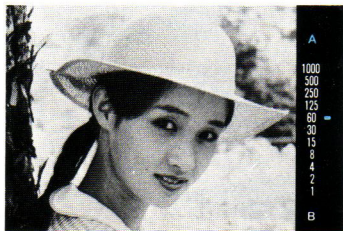

1. Shift the camera's position so the subject fills most of the frame. For small subjects, you may need to move closer (or zoom closer).

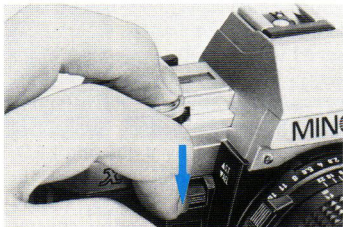

2. Press the AE lock all the way down and hold it.



3. While still holding the AE lock down, recompose your picture as desired and press the operating button all the way down to release the shutter.

#### NOTE

- The AE lock cannot be used in manual mode or with the self-timer.
- If you wish to change the aperture, do so before pressing the AE lock.
- For precise exposure control when using the AE lock with a variable-effective-aperture zoom lens (such as Minolta 35–105mm f/3.5–4.5 MD Zoom), slightly adjust the aperture after engaging the AE lock to compensate for the change when zooming (or do not zoom after engaging the lock). For exact compensation value, please refer to the zoom lens' owner's manual.
- When using an R60 (red) filter, adjust exposure +1 stop.



## MANUAL EXPOSURE MODE

### Basic setting

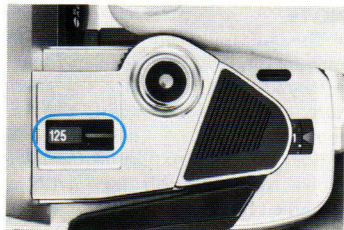

Set mode/shutter-speed selector at desired click-stop from "1" (1 sec.) to "1000" (1/1000 sec.).

### Viewfinder shows:

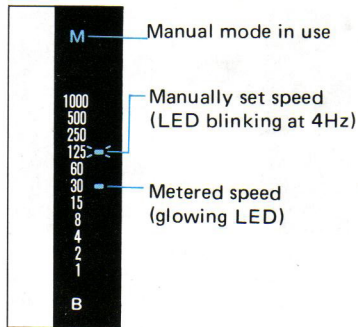

### Taking a picture

In the camera's match-LED manual mode, the manually set shutter speed is indicated in the viewfinder by an LED blinking at 4Hz (4 times per sec.), and the metered speed (for the aperture and film speed set) is indicated by a glowing LED. To obtain normal exposure as metered by your camera, simply adjust the aperture and/or shutter speed until the blinking and glowing LEDs match up.

### Darken picture

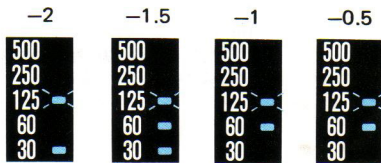

f-stops 16

(13)

11

(9.5)

### NORMAL (at EV13)



8

+0.5



(6.7)

+1



5.6

### Lighten picture

+1.5



(4.8)

+2



4

### Long exposure at "B" setting

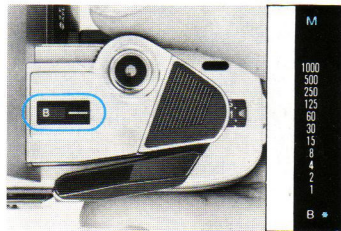

When the mode/shutter-speed selector is set at "B", the shutter will open when you press the operating button and remain open until you release the button. This makes exposure longer than one second possible. A tripod or other camera support should generally be used. To avoid shaking the camera when pressing the operating button or releasing the shutter, use a standard cable release (preferably a lockable type for longer exposures) or a

Minolta Remote Cord. The eyepiece cap (p. 22) should be used to prevent stray light from affecting the exposure.

#### NOTE

- The self-timer does not operate at the "B" setting.
- With fresh batteries at moderate temperatures, the maximum long exposure is approx. 10 hours. At lower temperatures, exposure time may be shorter.

## DEPTH OF FIELD

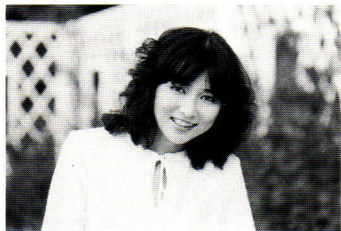

-A-

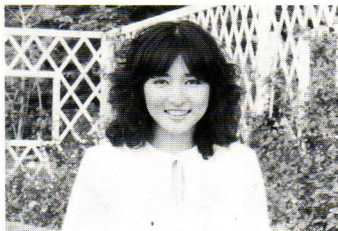

-B-

When a lens is focused on a given subject, there is a certain range behind and in front of the subject which appears sharp. This range is called "depth of field", and it varies according to the aperture set: large apertures (e.g.,  $f/1.7$ ) yield a shallow depth of field rendering the background out of focus (example **A**); small apertures (e.g.,  $f/22$ ) give greater depth of field with sharper background (example **B**). The depth of field can be checked on the lens' depth-of-field scale as shown.

Depth of field also varies with subject distance: when the lens is focused on a close subject, the depth of field is shallow; when focused on a distant subject, the depth of field is greater.

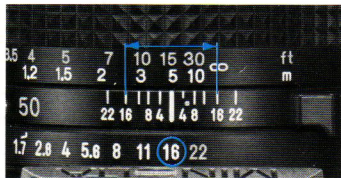
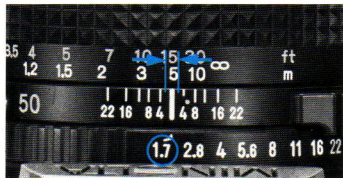

## SHUTTER SPEED

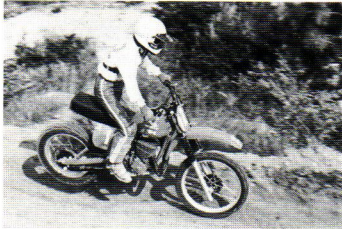

-A-

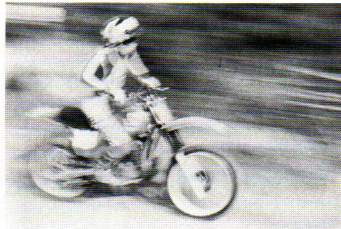

-B-

Sometimes the subject or the effect that you want makes the shutter speed more important. To set a desired shutter speed when using auto mode, turn the lens' aperture ring until the LED next to the desired shutter speed lights.

Fast shutter speeds such as  $1/500$  or  $1/1000$  sec. can "freeze" action (example **A**). Slow shutter speeds such as  $1/2$  or 1 sec. can be used to emphasize subject flow or motion (example **B**).



## OTHER FOCUSING METHODS



### Distance scale

You may find that in certain situations it is easier to focus by estimating the distance to your subject, then aligning the corresponding figure on the distance scale with the index, such as:

- When taking long exposures or flash pictures when it is too dark to focus through the lens
- If you want to prefocus on your subject, as in quickly shot candid photos

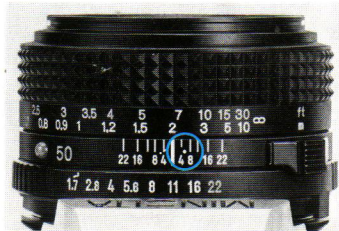

### Infrared index

For proper focus when using infrared film, first focus your subject as usual with visible light. Attach a red filter and turn the focusing ring to the right to align the point of proper focus on the distance scale with the small red dot (or red "R" on MC and old-type MD lenses) on the depth-of-field scale. Set exposure according to the film manufacturer's recommendations.

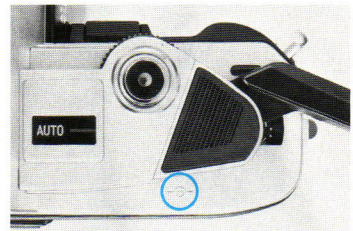

### Film-plane index

The symbol beneath the film advance lever indicates the position of the film inside the camera. This mark can be used for measuring the distance from subject to film when taking close-ups, photomicrographs, and photomicrographs, where the exact distance is sometimes important.

## FLASH PHOTOGRAPHY

### Connecting flash units

Cordless clip-on flash units, such as the Minolta Auto Electroflash 200X and 118X are attached and electrically connected by simply sliding them into the camera's hot shoe.

### Synchronization

When a Minolta X-series Auto Electroflash is used on the camera with its mode/shutter-speed selector at any position other than "B", the "60" LED in the viewfinder will blink as a flash-ready signal when the flash is turned on and fully charged, and the shutter will be automatically switched over to 1/60 sec. when the shutter is released.

If you use an electronic flash other than a Minolta X-series Auto Electroflash, the mode/shutter-speed selector must be set at "60" to assure complete exposure of the film frame. Slower speeds can also be used under certain conditions if desired for particular effects. Do not use speeds faster than 1/60 sec. (i.e., 1/125 and upward).

### NOTE

- For more detailed instructions, please refer to the flash unit's owner's manual.



## ACCESSORIES



### MOTOR DRIVE 1 and AUTO WINDER G

With Motor Drive 1 attached, you can capture the action with single-frame or continuous operation at either 2 or 3.5 frames per second. The comfortable handgrip has two operating buttons, each with a Minolta "touch switch", enabling full viewfinder readout for either horizontal or vertical framing.

Auto Winder G lets you focus full attention on the creative aspects of photography by freeing you from winding the film after each picture. Continuous sequences up to 2 frames per second are also possible by holding down the camera's operating button.

Both units are designed to attach quickly and easily to your X-370 without access caps to remove or store. Their film-advance mechanisms stop automatically at the end of the roll, and film can be easily loaded and unloaded without removing the units.





### AUTO ELECTROFLASHES

Taking flash pictures is as simple and easy as taking normal shots with your camera when you use Minolta X-series Auto Electroflashes, such as the 118X and 200X. These automatic electronic flash units are designed for your camera, featuring dedicated-flash functions that electronically set the camera for proper X-sync, and activate a blinking flash-ready signal in the viewfinder when the flash is charged and ready to fire.

Other features are multiple auto-aperture settings, manual mode, and Ni-Cd battery power supply.



### WIRELESS CONTROLLER IR-1 SET

The IR-1 infrared transmitter/receiver set lets you trigger your camera from up to 60m (about 200 ft.) away for remote-controlled single-frame exposures, continuous sequences, or long exposures. When used with extra receivers, the three-channel transmitter enables independent operation of up to three cameras or groups of cameras, or simultaneous operation of an unlimited number of cameras.



## TECHNICAL DETAILS

**Type:** Quartz/electronically governed 35mm single-lens reflex auto-exposure (AE) camera

**Exposure-control modes:** Aperture-priority automatic ("AUTO") and match-LED/full-metered manual ("M")

**Lens mount:** Minolta SLR bayonet (54° rotating angle); coupling for full-aperture metering and automatic diaphragm control with Minolta MD and MC lenses

**Exposure control and functions:** Low-voltage, low-current computer circuit varies shutter speed steplessly according to aperture set in AUTO mode, to yield proper exposure for film speed set; auto-exposure range: EV 1 to EV 18 (e.g., 1 sec. at f/1.4 to 1/1000 sec. at f/16) at ISO 100/21° with f/1.4 lens; AE lock enabling holding meter reading for exposure at that value

**Shutter:** Quartz-controlled horizontal-traverse focal-plane type; stepless speeds 1/1000 to 4 sec. set automatically with selector dial at "AUTO" setting or fixed speeds 1 to 1/1000 sec. or "B" (bulb) set manually at detented indications; electromagnetic shutter release locks when voltage too low for proper operation

**Metering:** TTL center-weighted averaging type, by silicon photocell mounted at rear of pentaprism

**Film-speed range:** ISO 12/12° to 3200/36° set by film-speed dial that locks at 1/3-EV increments

**Mirror:** Triple-coated oversize instant-return slide-up type

**Viewfinder:** Eye-level fixed pentaprism type showing 95% of 24 x 36mm film-frame area; magnification: 0.9X with 50mm standard lens focused at infinity; power: -1D, adjustable with accessory snap-on eyepiece lenses; Acute Matte focusing screen with central horizontally oriented split-image focusing spot surrounded by microprism band; visible around frame: mode indication ("A" or "M"), shutter speed scale with LED setting indication for metered speed and manually set speed, 1-4 sec. auto-speed indication, over-/under-range LED indicators, "B" setting indication, flash-ready signal, automatic battery check; display and metering activated by normal finger contact, or slight pressing of operating button or by engaging AE lock, continue for 15 sec. after finger removed

**Flash sync and control:** Hot shoe for X sync; camera-control contact on hot shoe for automatic setting of shutter at 1/60 sec. (except when mode/shutter-speed selector at "B") and flash-ready signaling with X- and PX-series Auto Electroflashes; other electronic flashes synchronize at 1/60 sec. and slower manual speeds or "B" setting; Class MF, M, and FP flashbulbs, at 1/15 sec. or slower setting

**Film advance:** Manual: by lever with single 130° stroke after 30° unengaged movement; motorized with accessory Motor Drive 1 or Auto Winder G; release button for rewind on camera bottom; advancing-type frame counter; Safe Load Signal indicating film loading and advancing condition

**Power:** Two 1.5v alkaline-manganese (LR44: Eveready A-76 or equiv.), two 1.55v silver-oxide (SR44: Eveready S-76, EPX-76 or equiv.), or one 3v lithium (CR-1/3N) cell(s) power both auto exposure control and manual operation; main switch with indication for off or on; mode LED blinks when cells approach exhaustion; no LEDs light and shutter will not release when voltage is too low for proper operation

**Self-timer:** Electronic for 10-sec. delay, with operation indicated by camera-front LED that blinks at 2Hz for 8 sec., then 8Hz for 1 sec., then remains on until shutter releases, cancelable anytime before release

**Other:** Integral front handgrip; back with memo holder, and ISO (DIN·ASA) table; positive 4-slot take-up spool; remote shutter-release socket

**Size and weight:** 137 x 90 x 51.5mm (5-3/8 x 3-9/16 x 2 in.), 470g (16-9/16 oz.) without lens and power cell(s)

**Standard accessories:** Carrying strap with slide-on battery holder and eyepiece cap

**Optional accessories:** Minolta Auto Electroflashes; Motor Drive 1, Auto Winder G; Wireless Controller IR-1 Set; MD, MC, and other Minolta interchangeable lenses and applicable Minolta SLR system accessories

Specifications subject to change without notice

## CARE AND STORAGE

- Always keep your camera in its case with the lens capped when not in use, or with a body cap on when a lens is not attached.
- No part of the camera should be forced at any time.
- Never subject your camera to shock, high heat, high humidity, water, or harmful chemicals. Be particularly careful not to leave it in the glove compartment or other places in motor vehicles where it may be subjected to high temperatures.
- Never lubricate any part of the camera body or lens.
- Never touch the shutter curtains or the front inside part of the body or blow against them, as doing so might damage the alignment and movement of either the curtains or mirror.
- External camera and lens barrel—but not glass—surfaces should be wiped with a clean, dry, or silicone-treated cloth now and then, especially after using near salt water.
- It is advisable to operate the film-advance lever and release the shutter once or twice from time to time during extended storage.
- Never touch lens or eyepiece surfaces. Remove loose matter with a blower brush. If necessary, clean with a soft, clean cloth or special photographic lens tissue which may be moistened with not more than one drop of a quick-evaporating fluid cleaner specially compounded for photographic lenses. Never drop fluid directly on the glass surface.
- It is recommended to have your camera cleaned once per year at an authorized Minolta service facility.
- If the camera is to be stored for a long period of time, remove the batteries and keep in a cool, dry place away from dust or chemicals, preferably in an airtight container with a drying agent such as silica gel.

If you have questions concerning the operation of your camera, feel free to contact your local Minolta agent or distributor by writing one of the offices listed below.

To assure prompt service, please contact your Authorized Independent Service Center before sending your camera for repairs.

---

**Minolta Camera Co., Ltd.**

**Minolta Camera Handelsgesellschaft m.b.H.**

**Minolta France S.A.**

**Minolta (UK) Limited**

**Minolta Austria Gesellschaft m.b.H.**

**Minolta Nederland B.V.**

**Minolta (Schweiz) GmbH**

**Minolta Svenska AB**

**Minolta Corporation**

**Head Office**

**Los Angeles Branch**

**Chicago Branch**

**Atlanta Branch**

**Minolta Canada Inc.**

**Head Office**

**Montreal Branch**

**Vancouver Branch**

**Minolta Hong Kong Limited**

**Minolta Singapore (Pte) Ltd.**

**30, 2-Chome, Azuchi-Machi, Higashi-Ku, Osaka 541, Japan**

Kurt-Fischer-Strasse 50, D-2070 Ahrensburg, West-Germany

357 bis, rue d'Estienne d'Orves, 92700 Colombes, France

1-3 Tanners Drive, Blakelands North, Milton Keynes, MK14 5BU, England

Amalienstraße 59-61, 1131 Wien, Austria

Zonnebaan 39, Postbus 264, 3600 AG, Maarssenbroek-Maarssen,

The Netherlands

Riedhof V, Riedstrasse 6, 8953 Dietikon-Zürich, Switzerland

Brännkyrkagatan 64, Box 17074, S-10462 Stockholm 17, Sweden

101 Williams Drive, Ramsey, New Jersey 07446, U.S.A.

3105 Lomita Boulevard, Torrance, CA 90505, U.S.A.

3000 Tollview Drive, Rolling Meadows, IL 60008, U.S.A.

5904 Peachtree Corners East, Norcross, GA 30071, U.S.A.

1344 Fewster Drive, Mississauga, Ontario L4W 1A4, Canada

376 rue McArthur, St. Laurent, Quebec H4T 1X8, Canada

1620 W. 6th Avenue, Vancouver, B.C. V6J 1R3, Canada

Oriental Centre Ground Floor, 67-71 Chatham Road South,

Kowloon, Hong Kong

10, Teban Gardens Crescent, Singapore 2260



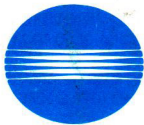

MINOLTA

© 1984 Minolta Camera Co., Ltd. under the Berne Convention  
and Universal Copyright Convention

9222-2025-31

N410-B6 Printed in Japan