

WILSONWERKS ARCHIVES

This camera manual is for reference and historical purposes, all rights reserved.

This cover page is copyrighted material. This document may not be sold or distributed without the express consent of the publisher.

©2008 wilsonwerks Llc

Nikon

N5005

AF

INSTRUCTION MANUAL

CONTENTS

FOREWORD	4
NOMENCLATURE	5-7

BASIC OPERATION	8-20
MOUNTING THE LENS	8
INSTALLING BATTERIES	9
CHECKING BATTERY POWER	10-11
LOADING FILM	12-13
BASIC SHOOTING	14-17
REWINDING FILM	18-19

FOCUS	20-27
AUTOFOCUS	20-23
With a stationary subject	20
With a moving subject	21
Taking pictures with an off-center main subject	22
Autofocusing with AF illuminator	23
MANUAL FOCUS WITH ELECTRONIC FOCUSING	
CONFIRMATION	24
MANUAL FOCUS USING CLEAR MATTE FIELD	25
SPECIAL FOCUSING SITUATIONS	26-27

EXPOSURE	28-36
SHUTTER SPEED DIAL AND APERTURE DIAL	28
PROGRAMMED AUTO EXPOSURE MODE -	
AUTO MULTI-PROGRAM	29
SHUTTER-PRIORITY AUTO EXPOSURE MODE	30-31
APERTURE-PRIORITY EXPOSURE MODE	32-33
MANUAL EXPOSURE MODE	34-36
T setting	36

EXPOSURE METERING SYSTEM	37-43
MATRIX METERING	37
CENTER-WEIGHTED METERING	37
MATRIX METERING VS.	
CENTER-WEIGHTED METERING	38-41
CENTER-WEIGHTED METERING FOR	
SPECIAL EXPOSURE SITUATIONS	42-43
AEL (Auto Exposure Lock) button	42
Manual exposure mode	43

SELF-TIMER	44-45
-------------------------	-------

FLASH PHOTOGRAPHY	46-64
AUTOMATIC BALANCED FILL-FLASH	46-47
Matrix Balanced Fill-Flash	47
Center-Weighted Fill-Flash	47
USING BUILT-IN TTL FLASH	48-61
Notes on selecting aperture	48
Operation in programmed	
auto exposure mode	49-51
Operation in shutter-priority	
auto exposure mode	52-54
Operation in aperture-priority	
auto exposure mode	55-57
Operation in manual exposure mode	58-60
USABLE AF NIKKOR LENSES	61
BUILT-IN TTL FLASH SPECIFICATIONS	62-63
SPEEDLIGHT COMPATIBILITY CHART	64

LENSES	65-66
ACCESSORY COMPATIBILITY	67
CAMERA CARE TIPS	68-70
NOTES ON BATTERIES	70-71
SPECIFICATIONS	72-75
GLOSSARY	76-78
VIEWFINDER INFORMATION	79

FOREWORD

Thank you for purchasing this Nikon product. We hope you enjoy the Nikon N5005, and we're sure it will make photography a bigger part of your life.

Get to know your N5005, but before using it, be sure to read this manual thoroughly.

Nikon cannot be held responsible for malfunction resulting from the use of the camera other than as specified in this manual.

The Nikon autofocus SLR system is designed based on the premise that any of its components, such as the F4 series, N8008s, N8008, N6006, N5005, N4004s, N2020, AF Nikkor lenses and Nikon accessories will be used integrally, with one another.

AF Nikkor lenses electronically communicate all the necessary information required for perfect operation within current and future Nikon autofocus SLR systems.

Nikon does not assume responsibility if malfunctions or damage occurs to the N5005 when lenses and/or accessories of other makers are used with it. For this reason, we recommend the use of AF Nikkor lenses and Nikon system accessories.

NOMENCLATURE

Aperture dial

Film rewind button

Frame counter

Dial lock-release button

Self-timer indicator LED

Shutter release button

Shutter speed dial

Handgrip

AEL (Auto Exposure Lock) button

Minimum aperture lock

Aperture scale

Focusing ring

Accessory shoe

Film plane indicator

Self-timer button

Flash lock-release buttons

Flash head

Lens mounting index

Lens release button

Focus mode selector

Aperture ring

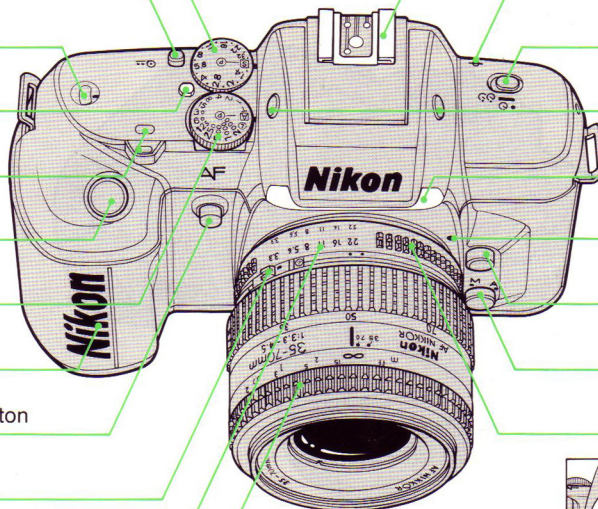

**Lens (AF Zoom-Nikkor
35-70mm f/3.3-4.5)**

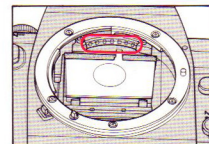

CPU contacts: Do not touch.

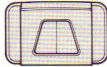
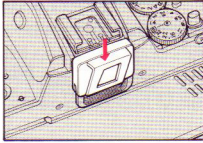

Eyepiece cover DK-5 (provided): Prevents stray light from entering viewfinder.

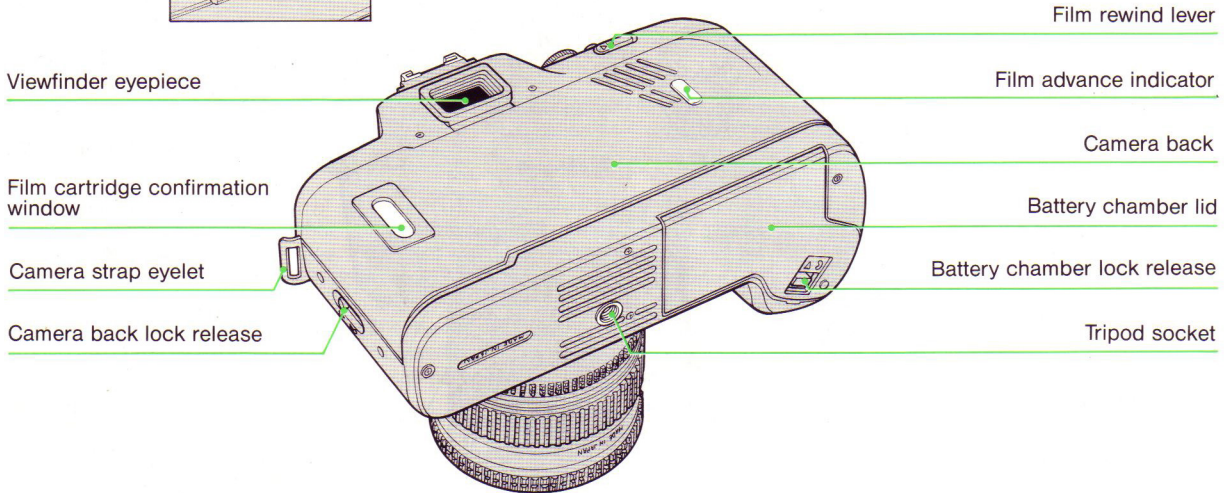

Inside viewfinder

12mm-dia. central area

Clear matte field

Focus brackets

Exposure indicator LEDs

Focus indicator LED

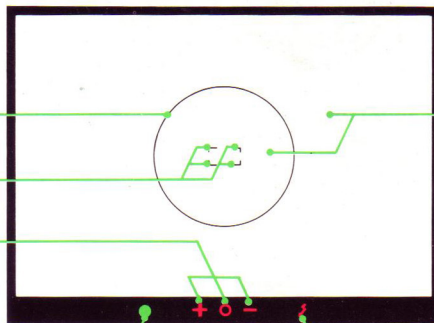

Flash ready-light

BASIC OPERATION

MOUNTING THE LENS

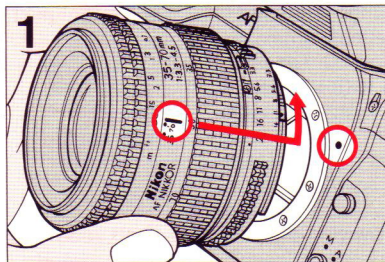

Twist lens counterclockwise until it securely clicks into place.

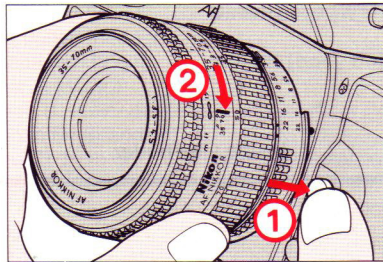

To remove

Push lens release button and turn lens clockwise. *Do not push lens release button except when removing lens.*

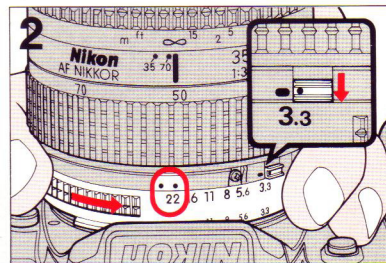

Set lens to its minimum aperture (largest f-number marked in orange on AF Nikkor lenses). Then lock lens aperture at its minimum setting. (See lens instruction manual.)

The N5005 is designed for use with AF Nikkor lenses, except AF-Nikkor 80mm f/2.8, ED 200mm f/3.5 IF, and Autofocus Converter TC-16/TC-16A. For limited use of non-AF Nikkor lenses, see pages 65 to 67.

With the N5005, all aperture setting operations are performed using the aperture dial on the camera body. Do not move lens' aperture ring once it is set to its smallest aperture (largest f-number).

INSTALLING BATTERIES

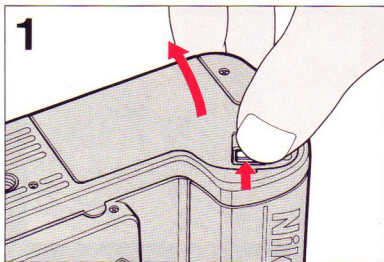

Open the battery chamber lid by sliding the lock release.

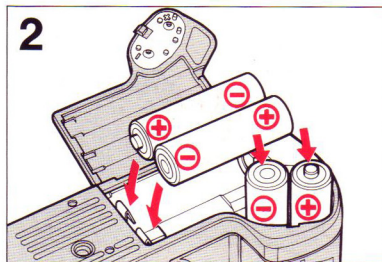

Install four fresh AA-type batteries with "+" ends positioned as shown inside the battery chamber.

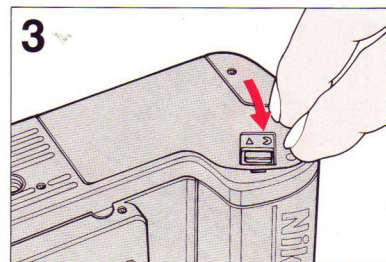

Close the battery chamber lid.

Batteries with a "+" terminal exceeding 6mm in diameter cannot be used.

CHECKING BATTERY POWER

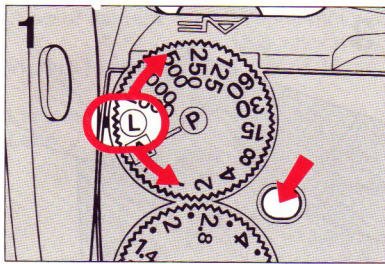

To turn the camera power on, rotate the shutter speed dial from L to another setting while pressing the dial lock-release button.

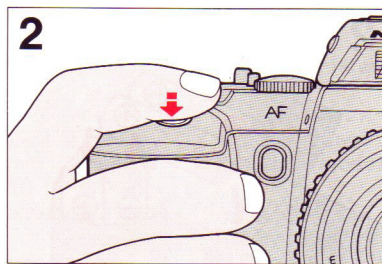

Lightly press shutter release button and check viewfinder exposure indicator LED(s) (+, ○ and/or -) to make sure battery power is sufficient. Exposure indicator LED(s) lights up or blinks if power is sufficient, and stays on approx. 8 sec. after you take your finger off the button.

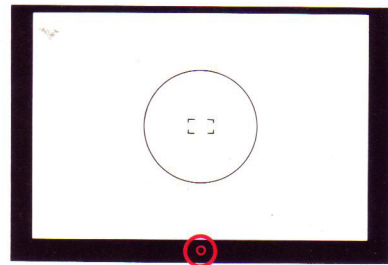

When not using the camera, be sure to set the shutter dial to L, to turn off power and conserve battery power.

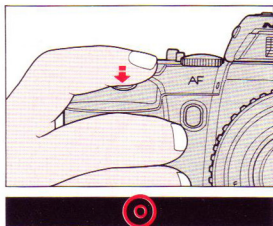

If LED goes off approx. 2 sec. after finger is removed from button, batteries need replacement.

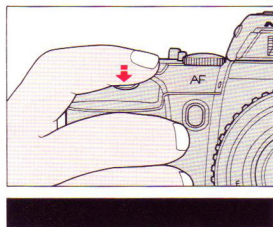
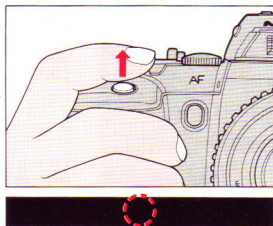

No LED, and shutter locks. Check battery installation or change batteries.

During shooting, replace batteries when:

- Film-advance speed, operation speed of autofocus lens or flash recycling time is noticeably slower, or
- Lightly pressing the shutter release button causes the self-timer indicator LED to start blinking and the shutter to lock.

At low temperatures or when weakened batteries are used, film advance may cause low battery voltage for a moment and the self-timer indicator LED may blink for a short while. However, you may be able to continue shooting.

The microcomputer in the N5005 may turn the camera off, even when batteries with sufficient power are properly installed. To start or resume operation, remove batteries and install again.

LOADING FILM

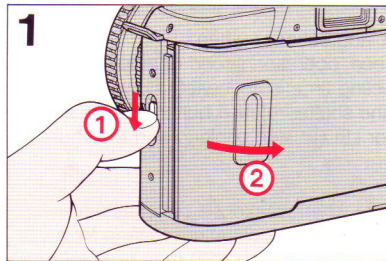

Slide down camera back lock release to open camera back.

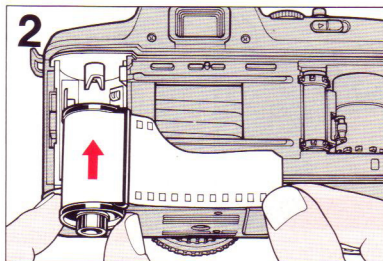

Insert film cartridge.

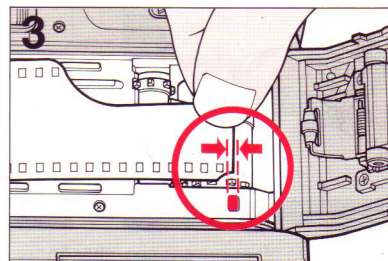

Pull film leader out to red index mark.

- Use only DX-coded film.
- Usable film speed range for DX-coded film is ISO 25 to 5000.
- All non-DX-coded films are automatically set to ISO 100.
- Avoid loading/unloading in direct sunlight.

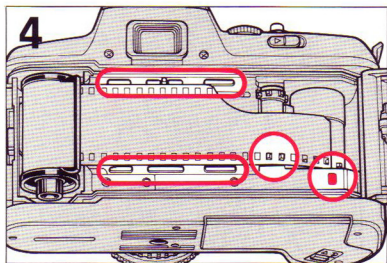

4 Check to make sure film is positioned properly, with no slack.

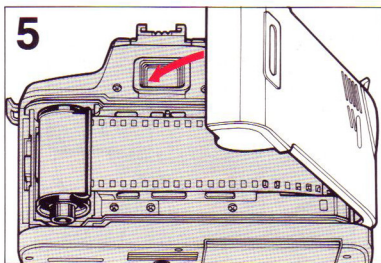

5 Close camera back and confirm lock-release snaps closed.

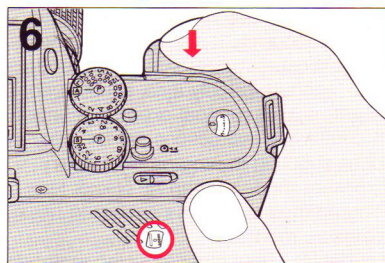

6 Fully depress shutter release button to automatically advance film to frame "1." Observe film advance indicator rotation to confirm proper film installation and transport.

- If film is not correctly installed, the self-timer indicator LED blinks. Set the shutter speed dial to L, then reset the dial to another setting while pressing the dial lock-release button. The self-timer indicator LED will disappear. Reload the film.

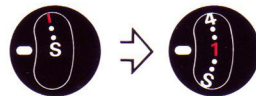
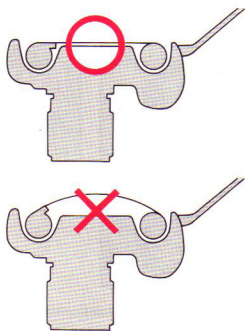

BASIC SHOOTING

The Nikon N5005 offers both auto and manual focusing. It also gives you three auto exposure modes — programmed auto, aperture-priority auto, shutter-priority auto — plus manual exposure control. The following instructions are for auto-focus shooting in programmed auto exposure mode with an AF Nikkor lens. Programmed auto is the easiest-to-use exposure mode.

For details about other focusing methods and exposure modes, see pages 20 to 27 and 28 to 36, respectively.

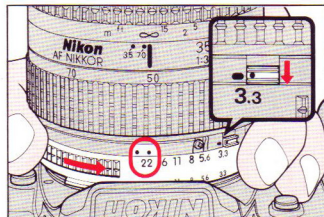

Confirm lens is set to smallest aperture (largest f-number); if lens is incorrectly set, the shutter release locks and + and - LEDs blink alternately inside the viewfinder. The self-timer indicator LED will also blink.

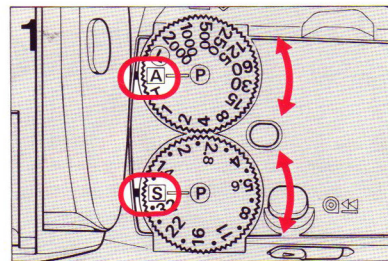

Set shutter speed dial to A, and aperture dial to S.

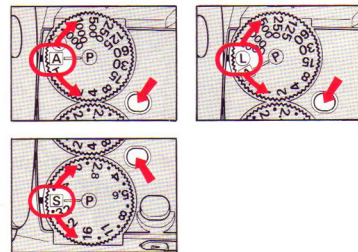

When both A and S are set, programmed auto mode is in operation.

The shutter dial locks at the A or L position, and the aperture dial locks at the S position. To release them, rotate the shutter or aperture dial while pressing the dial lock-release button.

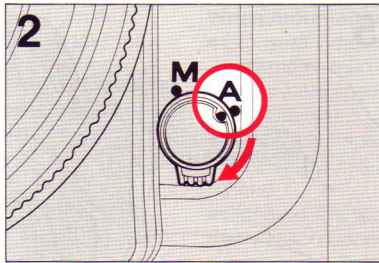

Set focus mode selector to A (autofocus). If the lens in use has an A-M switch, set the switch to A.

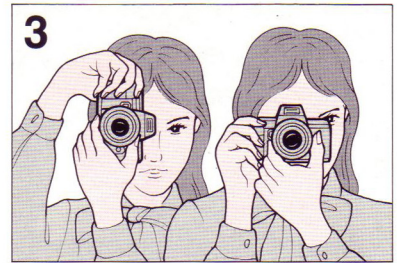

Aim camera at the subject.



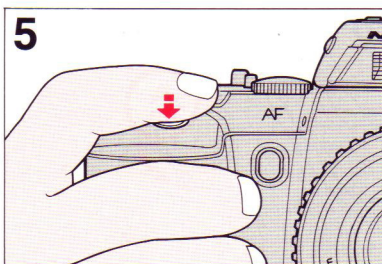

Position the viewfinder focus brackets () on the main subject.



Lightly press the shutter release button.



Confirm the green focus indicator LED  and the red exposure indicator LED  light up.

- If focus indicator LED ● blinks, see pages 26 to 27.
- If subject moves, remove your finger from shutter release button, then lightly press again to start autofocus with focus tracking.
- For details about autofocus, see pages 20 to 23.

○ **blinks** **Picture blur possibility (shutter speed is 1/[focal length] sec. or slower).**
 Use tripod to avoid camera shake, or use built-in TTL flash or accessory Nikon speedlight to synchronize shutter speed at 1/125 sec.

+ **lights up** ***Overexposure warning.**
 Too bright — very rare condition; use film with lower ISO speed.

- **lights up** ***Underexposure warning.**
 Too dark — use built-in TTL flash or accessory Nikon speedlight.

⚡ **blinks** Use built-in TTL flash or accessory Nikon speedlight. See pages 46 to 64.

*Shutter is locked.

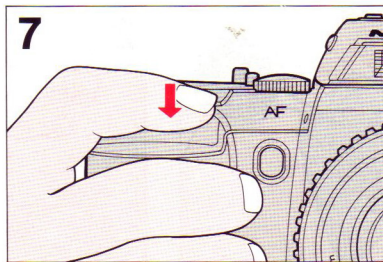

Fully depress shutter release button to take picture. This automatically advances film by one frame.

- Upon shutter release, the exposure indicator LED(s) turns off approx. 2 sec. after you remove your finger from the button.
- If camera detects abnormality during film advance (when film is loaded), the self-timer indicator LED blinks for a few seconds. If this happens, set the shutter speed dial to L (lock), then proceed as usual.

REWINDING FILM

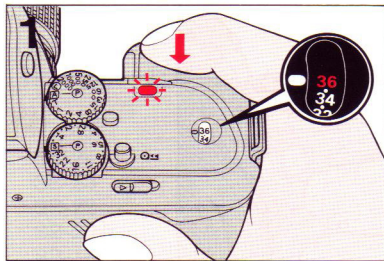

The film advance stops automatically at the end of the roll. Then, the self-timer indicator LED blinks for a few seconds and the shutter locks.

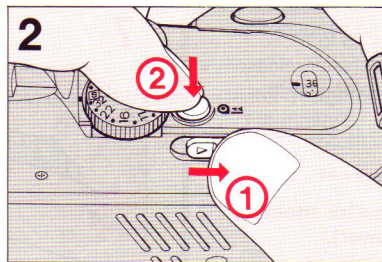

While sliding film rewind lever, push the film rewind button.

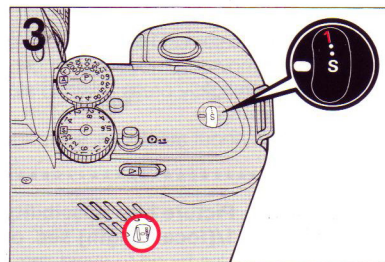

After rewinding stops, confirm film frame counter has returned to "S" and the self-timer indicator LED blinks (stops after approx. 2 seconds.)

If you do not rewind the film when you come to the end of the roll, each time the shutter release button is depressed, the self-timer indicator LED blinks for a few seconds to remind you to rewind it.

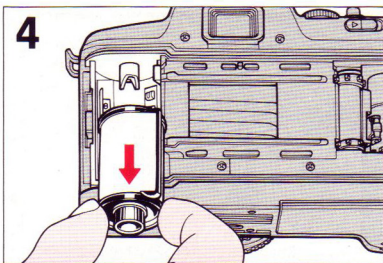

Open camera back and remove film cartridge.

FOCUS

AUTOFOCUS

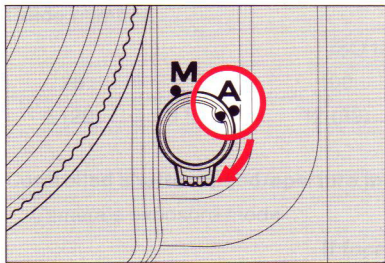

In autofocus mode, the shutter cannot be released until the subject is correctly focused, and once in focus, the focus is locked as long as the shutter release button remains lightly pressed.

If subject is moving, focus tracking works automatically. The focus tracking system enables the camera to analyze the speed of the moving subject according to focus detection data, and drive the autofocus lens by anticipating the position at the exact moment of exposure. So you can get correctly in-focus-pictures for most moving subjects, as well as stationary subjects.

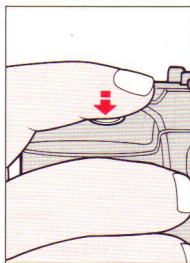

With a stationary subject

When subject is in focus, autofocus stops and ● appears. Once subject is in focus, focus is locked. If subject moves, remove your finger from shutter release button, then lightly press it again to start autofocus with focus tracking.

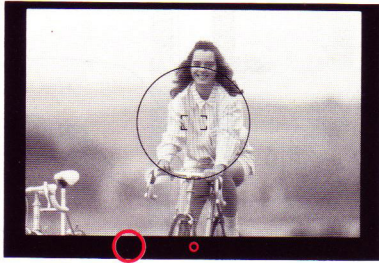
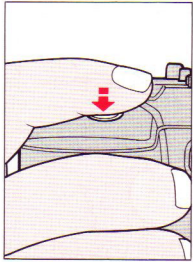

With a moving subject

Lightly pressing the shutter release button with a moving subject will activate the lens for focus tracking. The focus indicator LED ● will not appear during focus tracking. Confirm the subject is in focus on the matte field inside the viewfinder before fully depressing the shutter release button.

If subject stops, focus is locked. If subject moves again, remove your finger from the shutter release button and lightly press it again to start autofocus with focus tracking.

The shutter may lock if the subject moves irregularly or at an erratic speed.

With a moving subject, depending on subject status and lens in use, slightly-out-of-focus picture may result.

Taking pictures with an off-center main subject

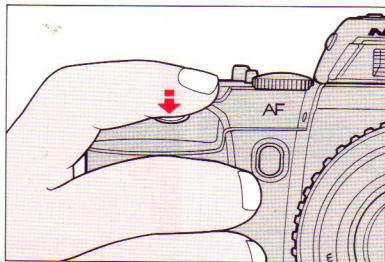
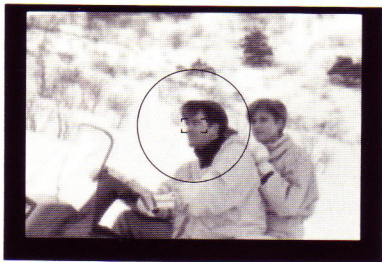

1. Center the focus brackets on the subject and lightly press the shutter release button.

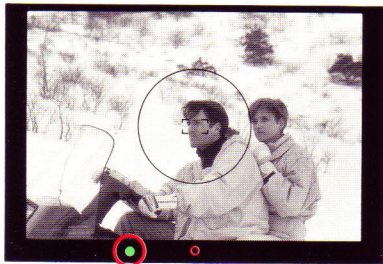

2. Confirm the focus indicator LED lights up.

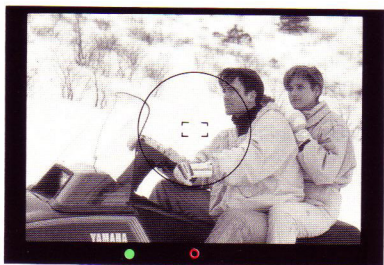

3. Keeping the shutter release button lightly pressed, recompose and fully depress the shutter release button.

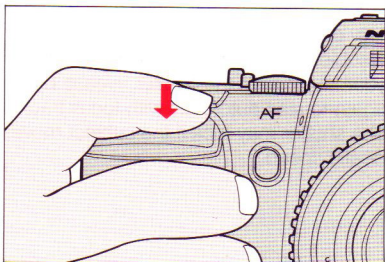

Autofocusing with AF illuminator

If existing light is insufficient for autofocus operation:

1. Mount Nikon Autofocus Speedlight SB-24/SB-23/SB-22/SB-20 on the accessory shoe of the N5005.
2. Lightly press the shutter release button.
3. The speedlight's AF illuminator lights up to start autofocus operation. For details, see speedlight instruction manual.

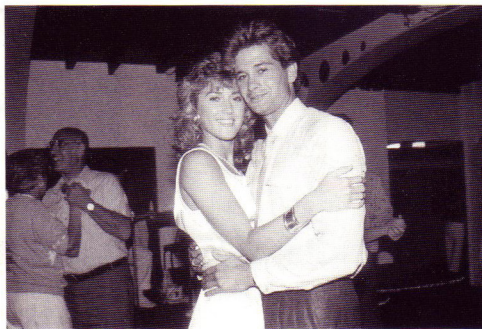
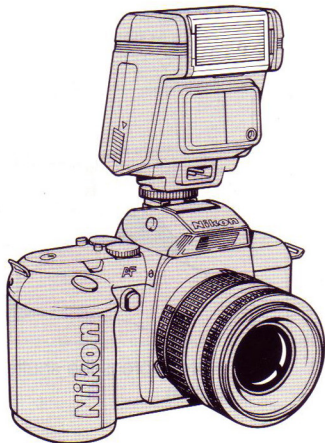

MANUAL FOCUS WITH ELECTRONIC FOCUSING CONFIRMATION

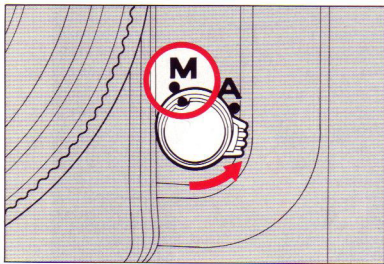

1. Set focus mode selector to M (manual). If the lens in use has an A-M switch, set the switch to M.

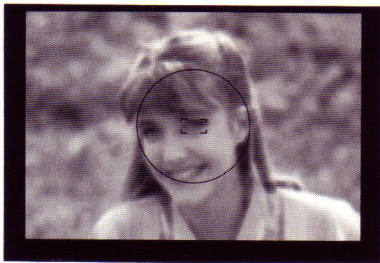

2. Look inside viewfinder and center the focus brackets on the main subject.

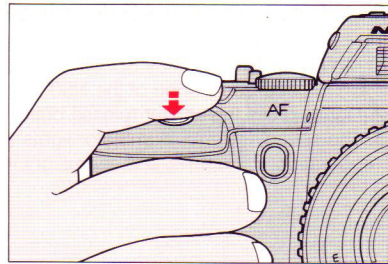

3. Lightly press the shutter release button.

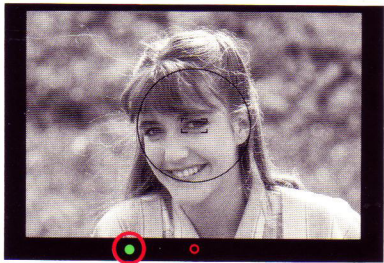

4. Keeping the shutter release button lightly pressed, watch the focus indicator LED in the viewfinder and rotate the lens focusing ring manually until the focus indicator LED lights up.

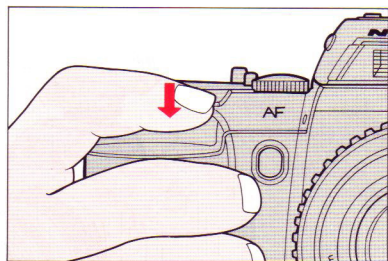
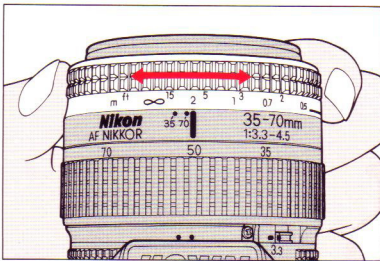

5. Fully depress the shutter release button.

MANUAL FOCUS USING CLEAR MATTE FIELD

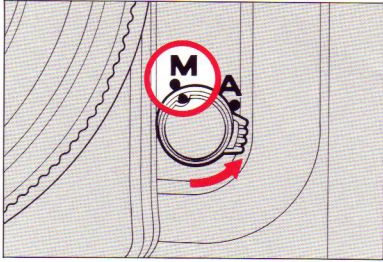

1. Set the focus mode selector to M (manual).



2. Focus subject using the clear matte field.

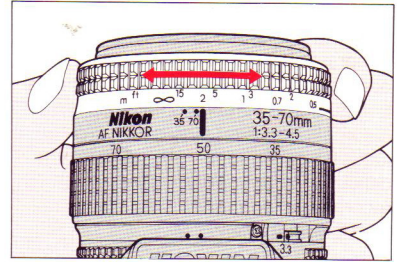

SPECIAL FOCUSING SITUATIONS

Autofocus operation and electronic focusing confirmation depend upon the general lighting of the scene, subject contrast and details, and other technical points. Under certain conditions, the automatic focusing system/electronic focusing confirmation may experience difficulty. In these circumstances, we recommend you focus manually using the clear matte field.

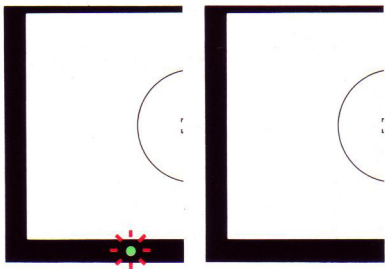

Focus indicator LED blinks or disappears with the following subjects:

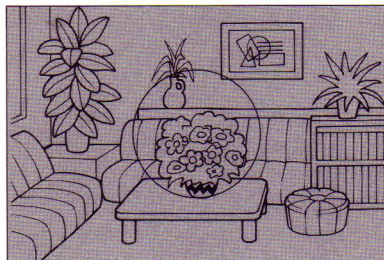

1) Very dark subject

Focus manually, or for autofocus, focus on another, brighter subject located at the same distance, or use accessory Nikon Autofocus Speedlight SB-24, SB-23, SB-22 or SB-20. (No other flash unit can be used.)

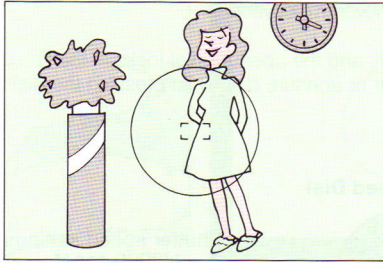

2) Low-contrast subject

Focus manually, or for autofocus, focus on another subject located at the same distance — but with more contrast — until the green focus indicator LED appears.

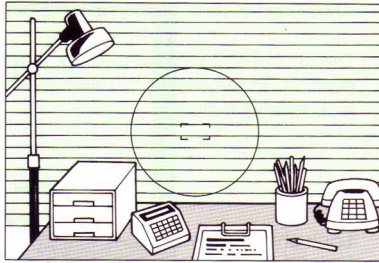

3) Subject with no vertical lines

Turn the camera sideways to focus, or focus manually. You may also select autofocus, then focus on another subject with vertical lines located at the same distance.

In the following situations, ignore focus-indicator LED and focus manually using the clear matte field.

- 1) When shooting the following:
 - Very bright subject with shiny surface, such as silver or aluminum.
 - Strongly backlit subject.
 - Scene with subject located at different distances.
- 2) When using a polarizing filter. (Circular polarizing filter can be used for autofocus operation.)

EXPOSURE

Exposure control consists of two parts – aperture control and shutter speed control. The aperture works basically the same way as the iris of the human eye and controls the amount of light passing through the lens. The shutter, located in the camera body, varies the amount of light admitted to the film by opening and closing at different speeds. Together, these two controls determine the amount of light that strikes the film, resulting in exposure control. Using the shutter speed and aperture dials of the N5005, you can select three different automatic exposure control modes and one manual mode.

SHUTTER SPEED DIAL AND APERTURE DIAL

Always set dials at click-stop positions – never in-between.

The shutter dial locks at the A or L position, and the aperture dial locks at the S position. To release them, rotate the shutter or aperture dial while pressing the dial lock-release button.

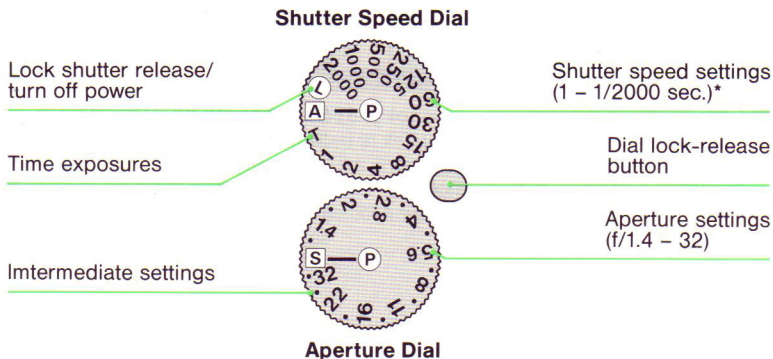

Shutter speed dial	Aperture dial	Exposure mode
A	S	Programmed auto
1 - 2000	S	Shutter-priority auto
A	1.4 - 32	Aperture-priority auto
T, 1 - 2000	1.4 - 32	Manual

* In programmed auto and aperture-priority auto exposure mode, shutter speed is automatically controlled from 30 to 1/2000 sec.

PROGRAMMED AUTO EXPOSURE MODE – AUTO MULTI-PROGRAM

Auto Multi-Program automatically sets the best combination of shutter speed and lens aperture, making it the easiest exposure mode to use.

Because lenses of different focal length handle differently at slow shutter speeds, picture sharpness varies with the shutter speed used. The slowest shutter speed recommended for any lens when hand-holding the camera is $1/(\text{focal length})$ of the lens. With a 60mm lens, for example, use 1/60 sec. as the slowest hand-held speed. Keep in mind, however, that 1/30 sec. is the lowest recommended shutter speed for blur-free hand-held shooting. The exposure program line for N5005's Auto Multi-Program varies according to the focal length and maximum aperture of the lens. The following chart shows how the possibility of picture blur is reduced by avoiding slower shutter speeds.

Auto Multi-Program chart

The EV (exposure value) charts demonstrate the differences among program lines of various lenses. Follow either colored line to where it intersects a diagonal line. This shows the combination of aperture (vertical line) and shutter speed (horizontal line) that will automatically be selected at each EV brightness level.

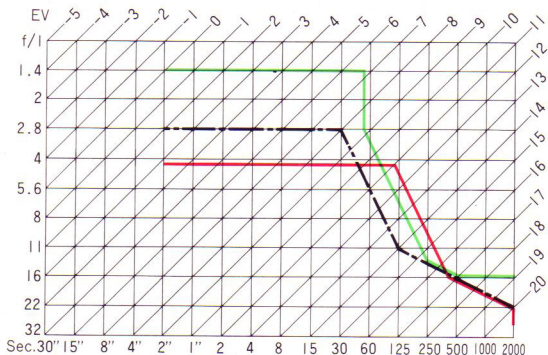

Auto Multi-Program Chart (ISO 100)

- With 50mm f/1.4
- - - With 28mm f/2.8
- With Zoom 35-135mm f/3.5-f/4.5 at 100mm (f/4.2) setting

SHUTTER-PRIORITY AUTO EXPOSURE MODE

This mode lets you choose shutter speeds manually, so you can freeze the action with sharp, clear outlines using fast shutter speeds, or create motion effects by choosing slower shutter speeds. The microcomputer in the N5005 automatically selects the correct aperture to match the shutter speed you set.



At a fast shutter speed



At a slow shutter speed

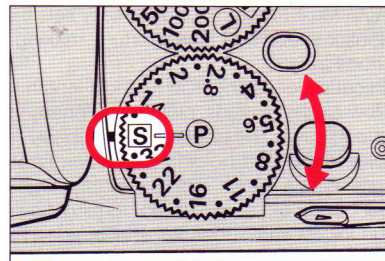

1. Set aperture dial to S.

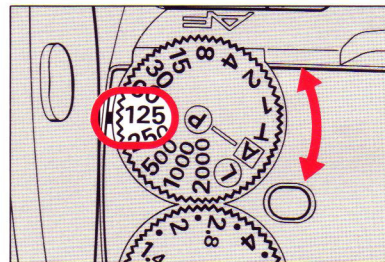

2. Set shutter speed dial to desired speed.

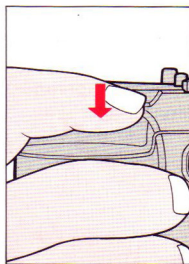
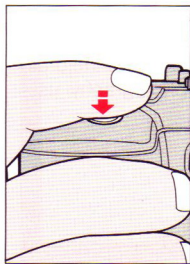

3. Look inside viewfinder and lightly press the shutter release button.

4. When the exposure indicator LED lights up, fully depress the shutter release button.

+ lights up* or + ○ light up	Select a higher shutter speed
- lights up* or ○ - light up	Select a slower shutter speed, or use built-in TTL flash or speedlight
+/- blink alternately*	Set lens to its smallest aperture setting
+/- disappear*	Shutter dial is set to "T"; select other position

*Shutter is locked.

APERTURE-PRIORITY EXPOSURE MODE

The microcomputer in the N5005 automatically selects the correct shutter speed to match the aperture you set. This is the recommended mode when depth of field is your prime consideration. To create softer, less distinct backgrounds, as in portraits, use wider apertures. For overall sharp, clear picture, such as scenic photography, use smaller apertures.



At wide aperture

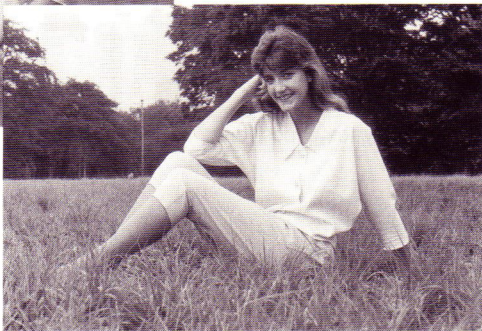

At small aperture

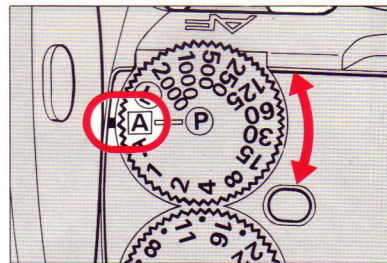

1. Set shutter speed dial to A.

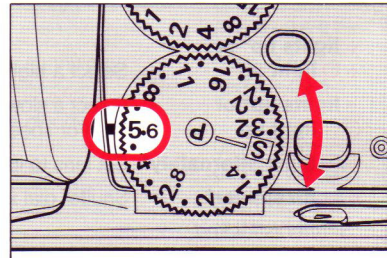

2. Set aperture dial to desired f-number.

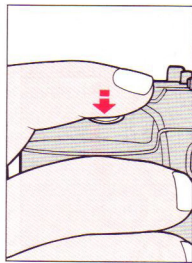

3. Look inside viewfinder and lightly press shutter release button.

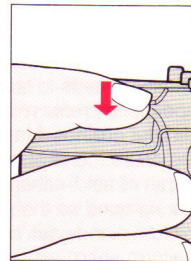
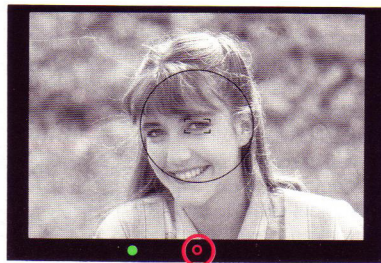

4. When the exposure indicator LED lights up, fully depress the shutter release button.

- | | |
|---------------------------------|---|
| ○ blinks | Picture blur possibility (shutter speed is $1/[\text{focal length}]$ sec. or slower). Select faster aperture setting (smaller f-number), or use a tripod to avoid camera shake. |
| + lights up* or
+ ○ light up | Select slower aperture setting (larger f-number). |
| - lights up* or
○ - light up | Select a faster aperture setting, or use built-in TTL flash or speedlight. |
| +/- blink alternately* | Set lens to its smallest aperture setting. |

*Shutter is locked

If aperture dial is set beyond lens' aperture range, aperture is automatically adjusted to minimum or maximum setting, whichever is nearest, and correct shutter speed is selected accordingly.

MANUAL EXPOSURE MODE

In manual exposure mode, both shutter speed and aperture can be set manually according to the desired effect. Use fast shutter speeds to stop the action, slower speeds to create motion effects or less distinct outlines. Manually setting the exposure mode also lets you control depth of field, either by softening the background so the main subject of the picture stands out, or by creating overall uniform sharpness.

Note that Center-Weighted Metering is selected in manual exposure mode.

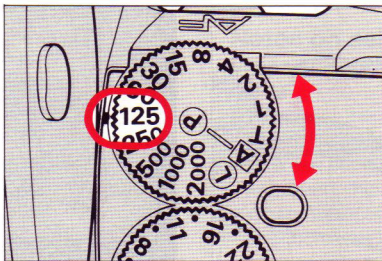

1. Set shutter speed dial to desired speed.

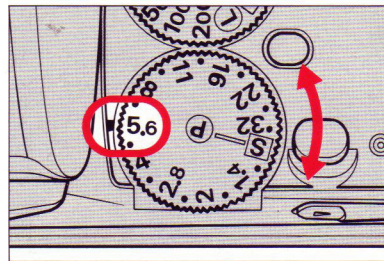

2. Set aperture dial to desired f-number.

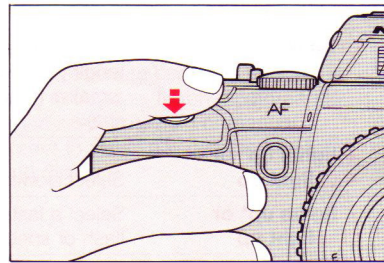

3. With your eye on the viewfinder, lightly press the shutter release button.

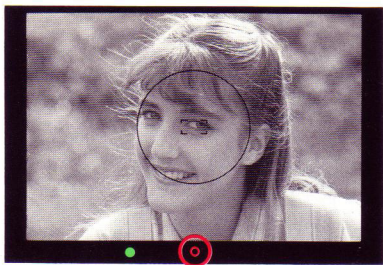

4. Rotate either shutter speed dial or aperture dial until exposure indicator LED lights up.

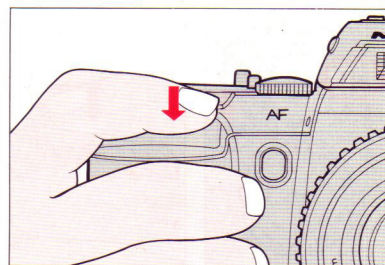
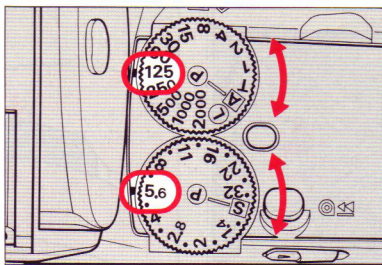

5. Fully depress the shutter release button.

+ or - LED lights up in the following cases*:

+	Overexposure warning	+1EV ~
+ ○	Overexposure warning	+1/3EV ~ +1EV
○	Correct exposure	-1/3EV ~ +1/3EV
○ -	Underexposure warning	-1EV ~ -1/3EV
-	Underexposure warning	~ -1EV

*Shutter does not lock in any of these cases.

If aperture dial is set beyond lens' aperture range, aperture is automatically adjusted to minimum or maximum setting, whichever is nearest.

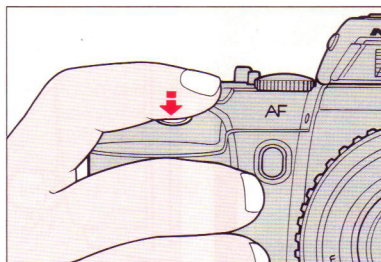
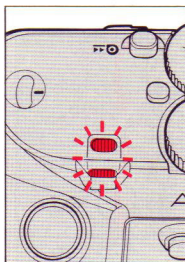
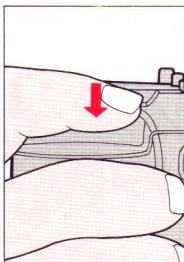
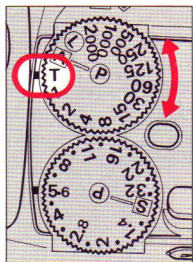

T setting

For long-time exposures, use the T setting.

To avoid camera shake, it is advisable to use a tripod.

1. Set the shutter speed dial to T.
2. Fully depress the shutter release button then remove finger from the button. After 0.5 sec., exposure begins.
3. During exposure, the self-timer indicator LED blinks every second.

4. To stop the exposure, lightly press the shutter release button.

- Long-time exposures can be performed in self-timer operation; for self-timer operation, see pages 44 to 45.
- A fresh set of alkaline-manganese batteries will allow you to perform long-time exposure for approximately seven hours.
- The T setting can only be used in manual exposure mode; be sure to set the aperture dial to a setting other than S. With the shutter speed dial at T and the aperture dial set at S, lightly pressing the shutter release button causes the self-timer indicator LED to blink.

EXPOSURE METERING SYSTEM

The Nikon N5005 provides two types of exposure metering systems — Matrix Metering and Center-Weighted Metering.

MATRIX METERING

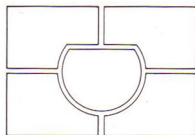

In auto exposure modes (programmed auto, shutter-priority auto and aperture-priority auto), Matrix Metering is selected. The Matrix Metering sensor determines scene brightness by dividing the scene into five areas, then analyzing each area for brightness and scene contrast. Thus, the meter automatically provides the correct exposure of the main subject in virtually any lighting situation, without requiring manual exposure compensation.

CENTER-WEIGHTED METERING

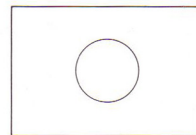

In manual exposure mode or when AEL (Auto Exposure Lock) button* is used, the camera automatically switches to Center-Weighted Metering. Center-Weighted Metering places special emphasis on brightness within the 12mm-diameter central area of the viewfinder, and is recommended for creating special effects.

**For AEL button, see page 42.*

MATRIX METERING VS. CENTER-WEIGHTED METERING

In scenes with both very bright and very dark areas, these two metering systems produce varying results. For example:

A. Scene containing the sun or scenes with high reflectivity

If a scene containing strong highlights, such as the sun, snow or bright reflections, Center-Weighted Metering renders the main subject as a silhouette. With Matrix Metering, however, the light value of darker parts is evaluated, resulting in an overall well-balanced exposure.

B. Outdoor backlit subject

With Center-Weighted Metering, a backlit subject or scene with people against a bright sky and/or clouds may lead to an underexposed subject. With Matrix Metering, however, the camera automatically gives more exposure to darker subjects to ensure a balanced overall exposure.

C. Front-lit subject against dark background

If a brightly lit off-center subject is positioned against a dark background, Center-Weighted Metering places too much emphasis on the dark center of the picture. So although the background is correctly exposed, the main subject will be overexposed. Matrix Metering, however, automatically integrates a dark background with a bright subject to ensure the best overall exposure.

Scene containing the sun

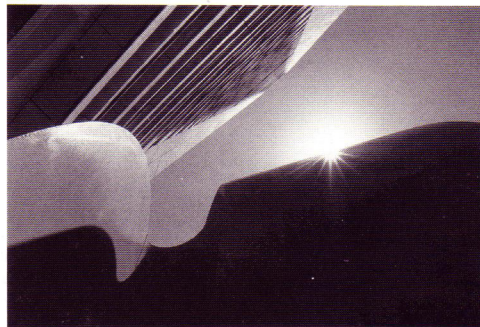

Matrix Metering

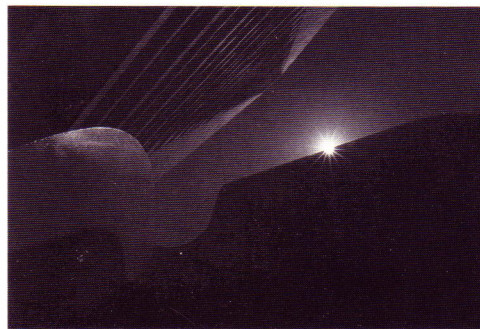

Center-Weighted Metering

Outdoor backlit subject



Matrix Metering



Center-Weighted Metering

Front-lit subject



Matrix Metering



Center-Weighted Metering

D. Small, dark subjects against a bright background

A subject significantly smaller than any one of the five sensor areas may not be recognized and integrated into the automatic exposure evaluation. For such subjects, we recommend you use either the AEL button or manual exposure control for Center-Weighted Metering.



Center-Weighted Metering (with AEL button)
Main subject is correctly exposed. For details, see page 42.



Matrix Metering



Center-Weighted Metering

E. Sunset scenes

When you want to emphasize a dramatic sunset, but don't want the Matrix Metering to lighten the scene for dark foreground subject, use the AEL button or manual exposure control for Center-Weighted Metering.



Matrix Metring

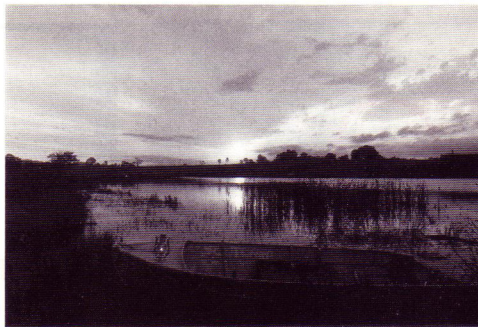

Center-Weighted Metering

CENTER-WEIGHTED METERING FOR SPECIAL EXPOSURE SITUATIONS

AEL (Auto Exposure Lock) button

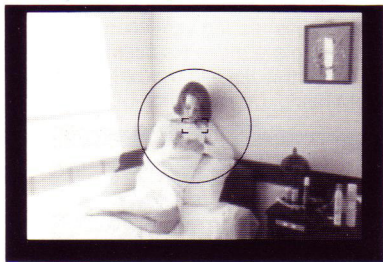

1. Center main subject inside viewfinder and/or move in closer so the 12mm circle is covered by the subject.

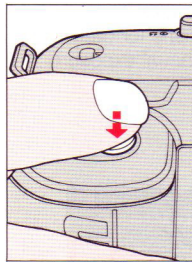

2. Lightly press shutter release button.

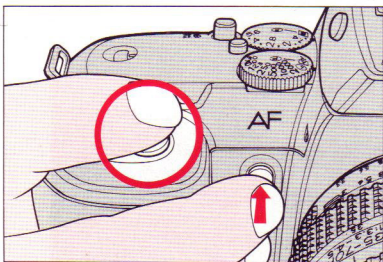

3. While lightly pressing shutter release button, depress the AEL button and hold it in.



4. Recompose and shoot.

- When recomposing may change the subject-to-camera distance, refocus by briefly removing your finger from the shutter release button and lightly pressing it again.

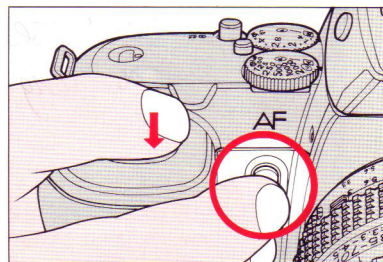

Manual exposure mode

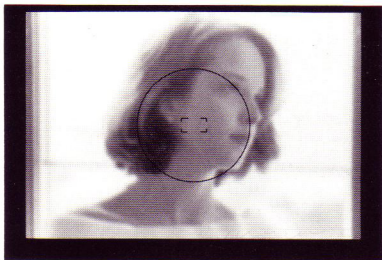

1. Center main subject inside viewfinder and/or move in closer so the 12mm circle is covered by the subject. Lightly press the shutter release button.

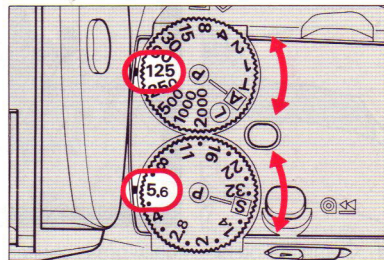
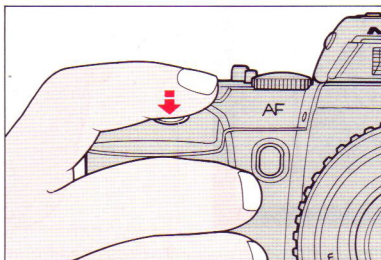

2. Adjust the shutter speed and aperture for correct exposure.



3. Confirm the exposure indicator LED lights up.

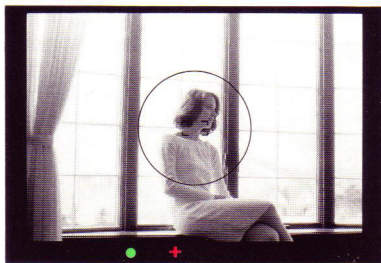

4. Recompose and shoot.
 - When recomposing may change the subject-to-camera distance, refocus by briefly removing your finger from the shutter release button and lightly pressing it again.

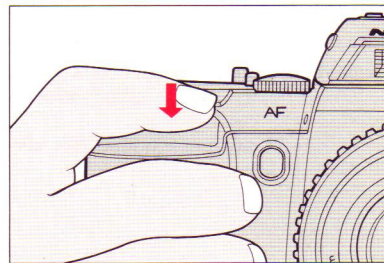

SELF-TIMER

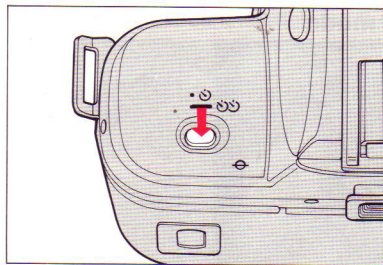
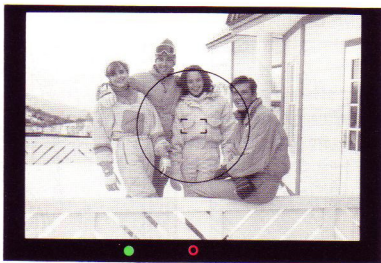
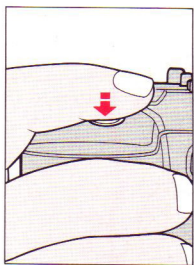

1. Compose picture, lightly press shutter release button, then confirm focus and exposure.

- *In self-timer operation, the shutter is released whether subject is in focus or not. To assure a focused image, focus subject before pressing self-timer button.*

2. Press self-timer button to start self-timer operation.
For one-shot self-timer: Press self-timer button and remove finger within two seconds (before self-timer indicator starts blinking).
For two-shot self-timer: Press self-timer button for three seconds or longer, confirm self-timer indicator LED has started blinking, then remove finger from the button.

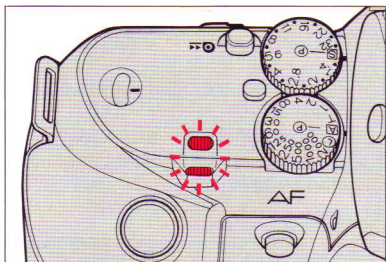

3. Shutter will be released after approx. 10 seconds. For the first seven seconds, self-timer indicator LED blinks; for the final three seconds, the LED lights up, warning you to get ready. For two-shot self-timer operation, the second shot will be taken five seconds after the first.

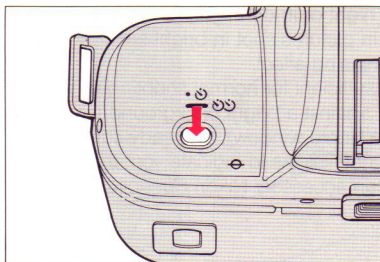

To cancel the self-timer after activating: Press self-timer button again.

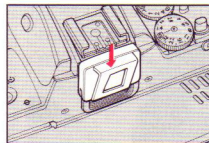

In programmed auto, shutter-priority auto or aperture priority-auto exposure mode, use eyepiece cover DK-5 to prevent stray light from entering the viewfinder.

FLASH PHOTOGRAPHY

Generally performed at night or in dim light, flash photography also removes shadows in pictures shot in bright sunlight, resulting in a more natural, pleasing effect.

When existing light is insufficient for normal shooting or when shooting a dark subject against a bright background (i.e., subject positioned against a bright window), the ready-light indicator LED inside the viewfinder blinks to indicate you should use the built-in TTL flash or an accessory Nikon Speedlight.



AUTOMATIC BALANCED FILL-FLASH

With either the Nikon N5005's built-in TTL flash or Nikon dedicated Speedlight set at TTL you can perform automatic balanced fill-flash.

With automatic balanced fill-flash, both the main subject and the background are correctly exposed.

There are two types of automatic balanced fill-flash — Matrix Balanced Fill-Flash with Matrix Metering and Center-Weighted Fill-Flash with Center-Weighted Metering.

Matrix Balanced Fill-Flash

As mentioned on page 37, Matrix Metering is automatically selected in auto exposure mode. In TTL auto flash photography, the Matrix Meter reads the scene's light levels/light pattern and signals the computer, which then calculates available-light exposure settings. When the shutter is released, the camera's TTL sensor senses the available light and flash illumination, then relays this information to the computer, which automatically controls flash operation. The computer automatically determines the appropriate amount of flash output compensation required. As soon as the right amount of flash illumination is output (with automatic compensation), the computer turns off the flash. The result is a well-balanced photo with correct exposure for both the background and foreground subject. All this takes place automatically and much quicker than it can be explained.

Center-Weighted Fill-Flash

If you want to choose the brightness level for a basic available-light exposure, set the camera's exposure mode to manual exposure mode to perform Center-Weighted Fill-Flash. By pointing the center-weighted area at different parts of the picture, you can choose the desired brightness level. If the brightness value you have selected is within the controlled shutter/aperture range*, flash output compensation will be made automatically for a natural fill-flash effect. If you select a brightness value beyond the controlled shutter/aperture range, flash will be output without compensation.

* See page 62.

The following shows operation with the built-in TTL flash. For flash photography operation with an accessory Nikon Speedlight, see the Speedlight instruction manual. For accessory Nikon Speedlight compatibility, see page 64.

USING BUILT-IN TTL FLASH

- Do not touch the flash when firing it; normal operation can make it quite hot.
- *Never fire the flash more than 20 consecutive times at intervals of 5 sec. or shorter. Firing continuously more than 20 times may impair flash performance. After each major flash shooting, let the flash rest at least 10 minutes before firing again.*

When you continuously fire the flash, the camera's handgrip may become hot due to normal operation. In this case, it will take longer for the ready-light come on because the flash automatically stops charging for a while.

- When battery voltage decreases due to low temperature or weak batteries, the ready-light may turn off even after it lights up once. Before shooting, make sure the ready-light is on.
- When the built-in TTL flash is up, an accessory Speedlight will not fire. When using a Speedlight, store the built-in TTL flash in the down position.
- Before shooting, make sure your subject is within the flash shooting distance range.
- Usable film speed range for the built-in TTL flash is ISO 25 to ISO 800.
- For usable lenses, see page 61.

Notes on selecting aperture

In aperture-priority auto and manual exposure mode

- The larger the aperture (the smaller the f-number) you select, the greater the maximum shooting distance, whereas the smaller the aperture (the larger the f-number), the less the maximum shooting distance.
- When subject distance remains the same, as the aperture increases, the depth of field becomes smaller. The smaller the aperture, the greater the depth of field.

In shutter-priority auto exposure mode

- With a slower shutter speed, a smaller aperture is automatically selected, causing a shorter shooting distance range.
- If shutter speed remains the same, as background brightness increases, the aperture becomes smaller. To perform flash shooting in daytime, Nikon recommends that you switch to aperture-priority auto or manual exposure mode in order to select a wider aperture for greater flash shooting distance.

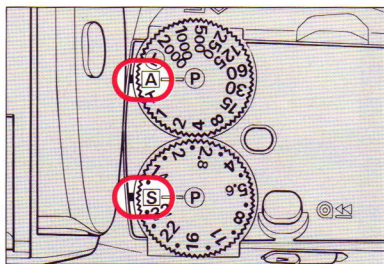

Operation in programmed auto exposure mode

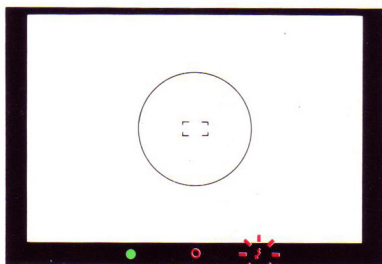

1. If subject brightness is insufficient, the viewfinder ready-light blinks to suggest that you use a flash.

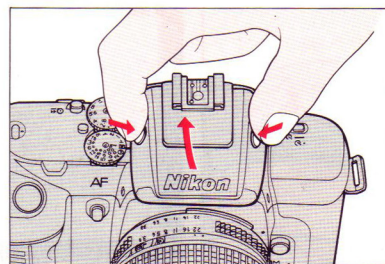

2. Press both flash lock-release buttons. The built-in TTL flash will pop up and automatically turn on.

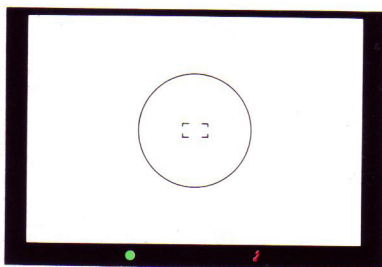
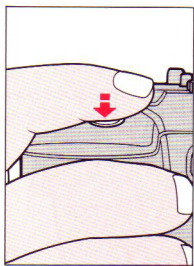

3. Compose picture and lightly press shutter release button.
- Do not use AEL button in Matrix Balanced Fill-Flash.
 - For controlled shutter speed/aperture, see table on page 62.

4. Make sure the subject is within the flash shooting distance range.

Guide for flash shooting distance range (at ISO 100):

For subjects backlit by the sun	0.6m~0.8m (2.0 ft.~2.6 ft.)
For outdoor subjects on sunny day	0.6m~1.5m (2.0 ft.~4.9 ft.)
For outdoor subjects on cloudy day or in shadows	0.7m~2.1m (2.3 ft.~6.9 ft.)
For indoor subjects	0.7m~4.3m (2.3 ft.~14.1 ft.)

The listed ranges should only be used as a guide. To choose desired flash shooting distance range, switch exposure mode to aperture-priority auto or manual.

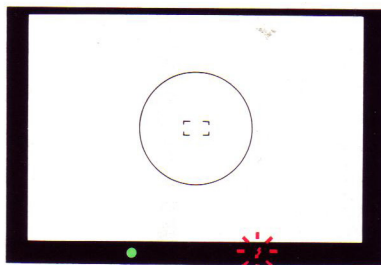
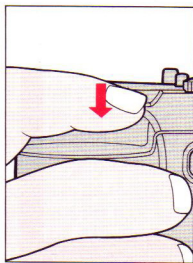
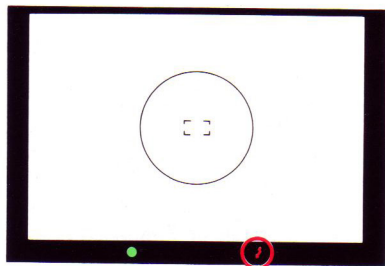

5. Confirm ready-light is on, then fully depress shutter release button to take a shot with the flash.

- *With ready-light off, the flash is charging and shutter remains locked.*

If ready-light blinks for a few seconds after shooting:

The flash has fired at its maximum output and light might be insufficient. Confirm shooting distance and, if necessary, move closer to subject, or switch exposure mode to aperture-priority auto to select a wider aperture.

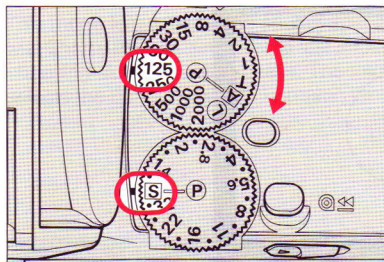

Operation in shutter-priority auto exposure mode

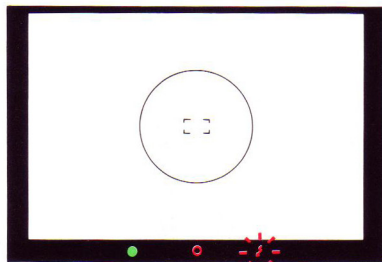

1. If subject brightness is insufficient, the viewfinder ready-light blinks to suggest that you use a flash.

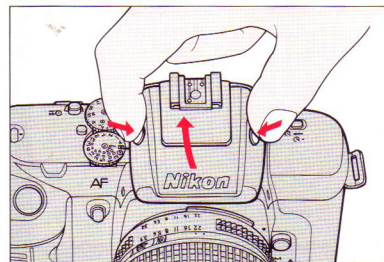

2. Press both flash lock-release buttons. The built-in TTL flash will pop up and automatically turn on.

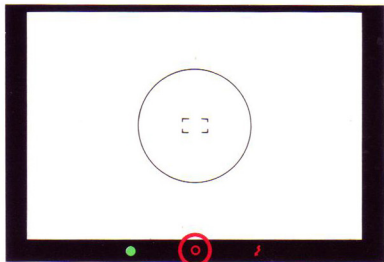
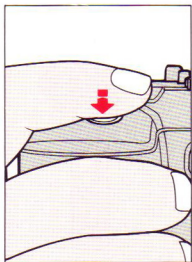

- 3.** Compose picture and lightly press shutter release button. Confirm exposure indicator LED for background exposure.

○ lights up	Correct exposure
+ or + ○ light up*	Background may be overexposed. Select faster shutter speed
- or - ○ light up*	Background may be underexposed. Select slower shutter speed. If - remains with a shutter speed of 1 sec., background will be underexposed

* With a flash, the shutter will not lock even if + or - lights up.

- For controlled shutter speed/aperture, see the table on page 62.
- Do not use AEL button in Matrix Balanced Fill-Flash.

- 4.** Make sure subject is within the flash shooting distance range.

Guide for flash shooting distance range (at ISO 100):

For subjects backlit by the sun	0.6m~0.8m (2.0 ft.~2.6 ft.) at 1/125 sec.
For outdoor subjects on sunny day	0.6m~1.5m (2.0 ft.~4.9 ft.) at 1/125 sec.
For outdoor subjects on cloudy day/in shadows	0.7m~2.1m (2.3 ft.~6.9 ft.) at 1/125 sec.
For indoor subjects	0.7m~4.3m (2.3 ft.~14.1 ft.) at 1/30 sec.

The listed ranges should only be used as a guide. To choose desired flash shooting distance range, switch exposure mode to aperture-priority auto or manual.

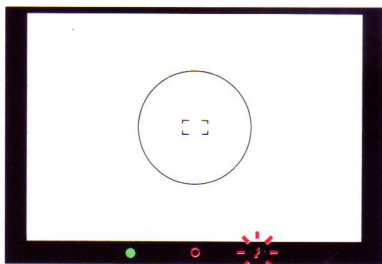
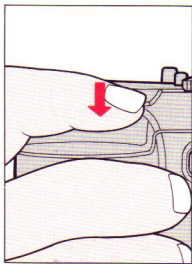
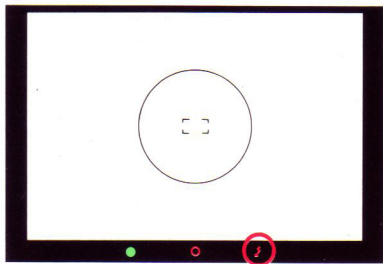

5. Confirm ready-light is on, then fully depress shutter release button to take a shot with the flash.

- *With ready-light off, the flash is charging and shutter remains locked.*

If ready-light blinks for a few seconds after shooting:

The flash has fired at its maximum output and light might be insufficient. Confirm shooting distance and, if necessary, move closer to the subject or switch exposure mode to aperture-priority auto to select a wider aperture.

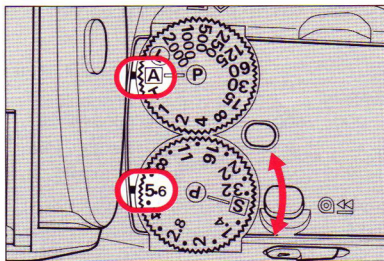

Operation in aperture-priority auto exposure mode

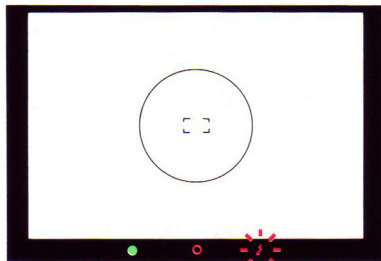

1. If subject brightness is insufficient, the viewfinder ready-light blinks to suggest that you use a flash.

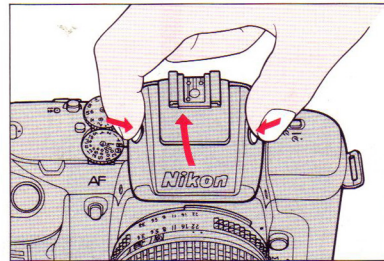

2. Press both flash lock-release buttons. The built-in TTL flash will pop up and automatically turn on.

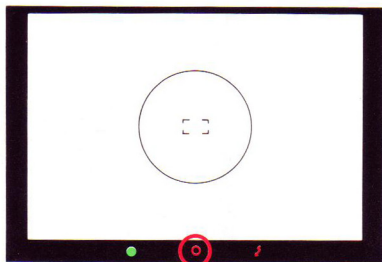
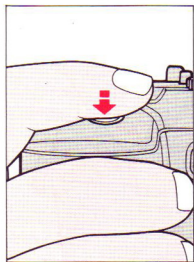

3. Compose picture and lightly press shutter release button. Confirm exposure indicator LED for background exposure.

- | | |
|--------------------|--|
| ○ lights up | Correct exposure |
| + or + ○ light up* | Background may be overexposed. Select smaller aperture (larger f-number) |
| - or - ○ light up* | Background may be underexposed. Select wider aperture (smaller f-number) |

* With a flash, shutter will not lock even if + or - lights up.

- For controlled shutter speed, see page 62.
- Do not use AEL button in Matrix Balanced Fill-Flash.

4. Make sure subject is within the flash shooting distance range.

Unit: m (ft.)

		ISO film speed					Flash shooting distance range
		25	50	100	200	400	
Aperture	-	-	-	-	2	2.8	4.0~12 (13.1~39.4)
	-	-	-	2	2.8	4	2.8~8.5 (9.2~27.9)
	-	1.4	2	2.8	4	5.6	2.0~6.0 (6.6~19.7)
	1.4	2	2.8	4	5.6	8	1.4~4.2 (4.6~13.8)
	2	2.8	4	5.6	8	11	1.0~3.0 (3.3~9.8)
	2.8	4	5.6	8	11	16	0.7~2.1 (2.3~6.9)
	4	5.6	8	11	16	22	0.6~1.5 (2.0~4.9)
	5.6	8	11	16	22	-	0.6~1.1 (2.0~3.6)
8	11	16	22	-	-	0.6~0.8 (2.0~2.6)	

You can also estimate the maximum shooting distance by guide number.

$$\frac{\text{guide number}}{\text{full aperture}} = \text{Maximum shooting distance}$$

i.e., if an f/4 lens is used at ISO 100:

$$\frac{12}{4} = 3\text{m or } \frac{39}{4} = \text{approx. } 9.8\text{ ft.}$$

Guide number for each ISO is shown on page 62.

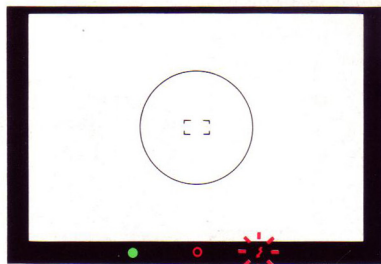
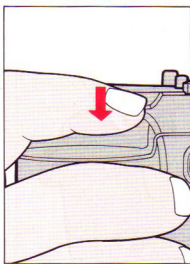
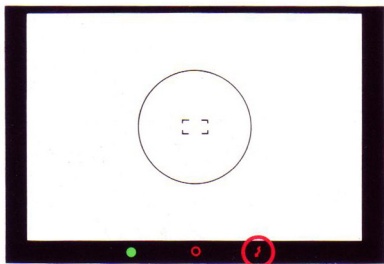

5. Confirm ready-light is on, then fully depress shutter release button to take a shot with a flash.

- *With ready-light off, flash is charging and shutter is locked.*

If ready-light blinks for a few seconds after shooting:

The flash has fired at its maximum output and light might be insufficient. Confirm shooting distance and, if necessary, move closer to subject or select a wider aperture.

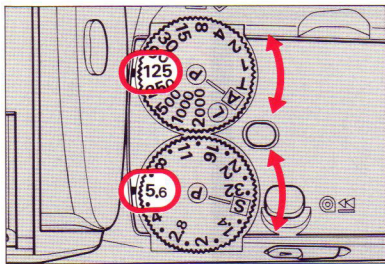

Operation in manual exposure mode

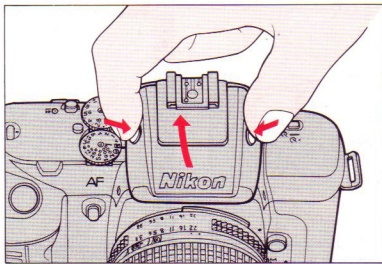

1. Press both flash lock-release buttons. The built-in TTL flash will pop up and automatically turn on.
 - *In manual exposure mode, the ready-light does not appear to recommend flash use.*

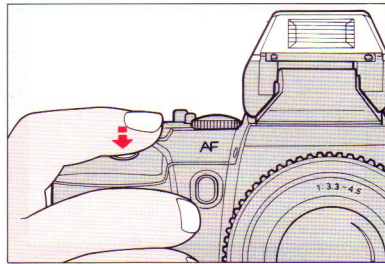

2. Look through the viewfinder, center camera on the area where you desire a correct exposure and lightly press the shutter release button.

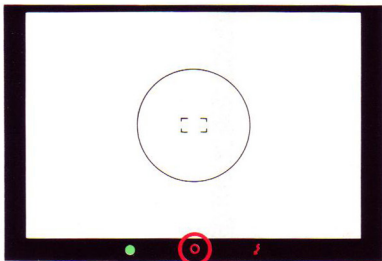

3. Confirm exposure indicator LED.

○ lights up	Correct exposure	
+ lights up	Background may be overexposed. (Over +1EV)	Select faster shutter speed and/or smaller aperture (larger f-number)
+ and ○ lights up	Background may be overexposed. (+1/3EV ~ +1EV)	
- and ○ lights up	Background may be underexposed. (-1/3EV ~ -1EV)	Select slower shutter speed and/or wider aper- ture (smaller f-number)
- lights up	Background may be underexposed. (Below -1EV)	

● For controlled shutter speed, see the table on page 62.

4. Make sure subject is within the flash shooting distance range. With ISO 100 film, for example, flash shooting distance range will be:

At f/2 2.0m ~ 6.0m (6.6 ft. ~ 19.7 ft.)

At f/2.8 1.4m ~ 4.2m (4.6 ft. ~ 13.8 ft.)

At f/4 1.0m ~ 3.0m (3.3 ft. ~ 9.8 ft.)

At f/5.6 0.7m ~ 2.1m (2.3 ft. ~ 6.9ft.)

At f/8 0.6m ~ 1.5m (2.0 ft. ~ 4.9 ft.)

At f/11 0.6m ~ 1.1m (2.0 ft. ~ 3.6 ft.)

At f/16 0.6m ~ 0.8m (2.0 ft. ~ 2.6 ft.)

For other film speeds, see the table on page 56. You can also estimate maximum shooting distance using the guide number.

$$\frac{\text{guide number}}{\text{full aperture}} = \text{Maximum shooting distance}$$

i.e., if an f/4 lens is used at ISO 100:

$$\frac{12}{4} = 3\text{m} \text{ or } \frac{39}{4} = \text{approx. } 9.8 \text{ ft.}$$

Guide number for each ISO is shown on page 62.

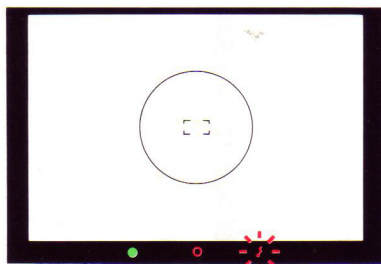
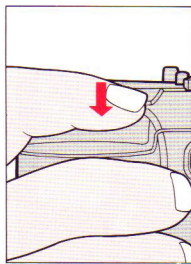
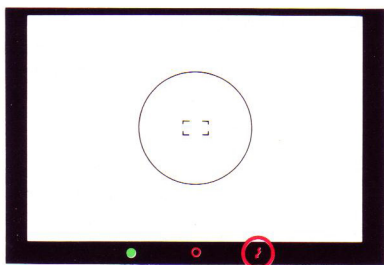

5. Recompose as desired, confirm ready-light is on, then fully depress shutter release button to take a shot with the flash.
- *With ready-light off, flash is charging and shutter remains locked.*

If ready-light blinks for a few seconds after shooting:
The flash has fired at its maximum output and light might be insufficient. Confirm shooting distance and, if necessary, move closer to subject or select a wider aperture.

USABLE AF NIKKOR LENSES

- All non-Zoom AF Nikkor lenses from 28mm to 300mm can be used, except AF Nikkor ED 300mm f/2.8 IF.
- Usable AF zoom lenses are:
 - AF 24-50mm f/3.3-f/4.5*
 - AF 28-70mm f/3.5-f/4.5**
 - AF 28-85mm f/3.5-f/4.5***
 - AF 35-70mm f/2.8****
 - AF 35-70mm f/3.3-f/4.5
 - AF 35-105mm f/3.5-f/4.5
 - AF 35-135mm f/3.5-f/4.5*****
 - AF 70-210mm f/4
 - AF 70-210mm f/4-f/5.6
 - AF 75-300mm f/4.5-f/5.6
 - AF 80-200mm f/2.8*****

- * *Cannot be used at a focal length shorter than 28mm, or when shooting a subject within 1m (3.3 ft.) at 28mm focal length.*
- ** *Cannot be used when shooting a subject within 1m (3.3 ft.) at a focal length shorter than 35mm.*
- *** *Cannot be used at a focal length shorter than 35mm, or when shooting a subject within 2m (6.6 ft.) at 35mm focal length.*
- **** *Cannot be used at a focal length shorter than 50mm.*
- ***** *Vignetting may occur when shooting a subject within 2m (6.6 ft.) at 35mm focal length.*
- ***** *Cannot be used when shooting a subject within 2m (6.6 ft.) at 80mm focal length.*

Note that zoom lenses cannot be used for macro focusing.

- Do not use a lens hood; it could cause slight vignetting.
- Use only AF Nikkor lenses.

BUILT-IN FLASH SPECIFICATIONS

Guide number

Unit: m (ft.)

Angle of coverage

28mm to 300mm

ISO film speed					
25	50	100	200	400	800
6 (20)	8.5 (28)	12 (39)	17 (56)	24 (79)	34 (112)

Controlled shutter speed/aperture in auto exposure mode

Camera's exposure mode	Controlled shutter speed	Controlled aperture
Programmed auto	If focal length in use is 60mm or shorter: 1/(focal length) sec., to 1/125 sec. If focal length in use is longer than 60mm: 1/60 to 1/125 sec.	Between available maximum aperture* and smallest aperture
Shutter-priority auto	As set on dial (1/125 sec. to 1 sec.)**	Between available maximum aperture* and smallest aperture
Aperture-priority auto	If focal length in use is 60mm or shorter: 1/(focal length) sec., to 1/125 sec. If focal length in use is longer than 60mm: 1/60 to 1/125 sec.	As set on dial
Manual	As set on dial (1/125 sec. to 1 sec. or T)**	As set on dial

* Depends on film speed. See table at right.

** If you set shutter speed dial to 1/250 or higher, shutter speed automatically switches to 1/125 sec., the camera's synchronization speed.

Controlled maximum aperture in programmed and shutter-priority auto exposure mode:

ISO film speed Lens in use	25	50	100	200	400	800
With f/1.4 lens	f/2	f/2.4	f/2.8	f/3.4	f/4	f/4.8
With f/3.3 lens	f/3.3	f/3.3	f/3.3	f/3.4	f/4	f/4.8
With f/4.5 lens	f/4.5	f/4.5	f/4.5	f/4.5	f/4.5	f/4.8

SPEEDLIGHT COMPATIBILITY CHART

Nikon Speedlight	Connecting	Speedlight's flash exposure mode			
		TTL auto		Non-TTL auto flash***	Manual flash***
		Matrix Balanced Fill-Flash*	Center-Weighted Fill-Flash**		
SB-24 SB-23 SB-22 SB-20 SB-16B SB-15	Direct	Yes	Yes	Yes (except SB-23)	Yes
SB-21B	Direct	Yes****	Yes****	No	Yes
SB-21A*****	Via AS-6	No	No	No	Yes
SB-11 SB-14 SB-140	Via SC-23	Yes	Yes	Yes	Yes
	Via SC-13 or AS-15	No	No	Yes	Yes
SB-17 SB-16A*****	Via AS-16	No	No	Yes	Yes
Medical-Nikkor 120mm f/4 IF	SC-22 (Provided)	Guide Number System (For details, see the lens' instruction manual.)			

* Possible when N5005 camera is set at programmed, shutter-priority or aperture-priority auto exposure mode.

** Possible when the N5005 camera is set at manual exposure mode.

*** Possible when the N5005 camera is set at aperture-priority auto or manual exposure mode.

**** Although possible with the SB-21B, Matrix Balanced Fill-Flash and Center-Weighted Fill-Flash are not recommended for close-up photography. With the N5005 camera, use SB-21 at manual flash exposure mode.

***** The difference between SB-21A and SB-21B, or between SB-16A and SB-16B, is the type of controller attached. (For details, see Speedlight instruction manual.)

LENSES

Nikon N5005 is designed for autofocus photography with AF Nikkor lenses (except AF-Nikkor lenses for F3AF). To take full advantage of the N5005's conveniences, it is recommended that you should use AF Nikkor lenses.

However, the following lenses can be used with the Nikon N5005 for manual focusing and manual exposure control, in line with the conditions listed at right.

MOUNTABLE NON-AF NIKKOR LENSES

AI-P Nikkor lenses

All AI-type Nikkor lenses (including AI-S and AI-modified)

Nikon Series E lenses

Reflex Nikkor lenses 500mm f/8

1000mm f/11 (No. 142360 or smaller, or
No. 143001 or larger)

2000mm f/11 (No. 200311 or larger)

PC-Nikkor lenses

28mm f/3.5

28mm f/4 (No. 180901 or larger)

35mm f/2.8 (No. 851000 or smaller, or
No. 906201 or larger)

Medical-Nikkor 120mm f/4

Teleconverters (except TC-16/TC-16A; they cannot be mounted)

Use of other lenses may damage the camera.

When mountable non-AF Nikkor lenses are used:

- Exposure indicator LEDs do not appear. Use external exposure meter, then set the exposure using lens aperture ring and shutter speed dial. Ignore the aperture set on camera's aperture dial.
- If the shutter speed dial is set at L or A, or the aperture dial is set at S, the self-timer indicator LED blinks and the shutter locks.
- Standard TTL flash is possible with built-in TTL flash or accessory Nikon Speedlight SB-24, SB-23, SB-22, SB-20, etc. To use flash or Speedlight, set shutter speed dial to 1/125 sec., or slower, then set the aperture using the lens' aperture ring. For Speedlight settings and shooting distance range, see Speedlight's instruction manual. Except for flash recommendation, ready-light functions as normal. Automatic balanced fill-flash is not possible.
- When using the N5005 with an AI-P-Nikkor lens, automatic exposure control is available but automatic focusing is not.

Lens compatibility

	Focusing			Exposure Control			
	Autofocus	Manual w/electronic focusing confirmation	Manual	Programmed auto	Shutter-priority auto	Aperture-priority auto	Manual
AF Nikkor lenses (except AF Nikkor lenses for F3AF)	○	○	○	○	○	○	○
AI-P Nikkor lens	×	△ ¹⁾	○	○	○	○	○
AI-type Nikkor lenses	×	△ ¹⁾	○	Camera's exposure meter does not operate and exposure indicator LEDs do not appear. Set exposure using the lens aperture ring and camera's shutter speed dial.			
Series E lenses	×	○	○				
Reflex Nikkor lenses ⁴⁾	×	×	○				
PC-Nikkor lenses ⁴⁾	×	△ ²⁾	○				
Medical-Nikkor 120mm f/4	×	○	○				
Teleconverters (except TC-16/TC-16A)	×	△ ³⁾	○				

- 1) With maximum aperture of f/5.6 or faster.
- 2) Unless lenses are **shifted**.
- 3) With maximum effective aperture of f/5.6 or faster.
- 4) Some lenses cannot be used.

ACCESSORY COMPATIBILITY

The following accessories cannot be used with the Nikon N5005.

- Cords that connect to remote terminal
- Accessories that connect to sync terminal
- Cable releases
- Neckstrap AN-1 (leather)
- Others:
PF-1~PF-3, PH-3, PB-2, PK-1~PK-3, PN-1, K2, BR-2
Accessories exclusively designed for other cameras

- If accessories such as close-up attachments are mounted directly on the lens mount of the N5005, exposure indicator LEDs do not appear. Set aperture using lens aperture ring.
- Filters with a larger exposure factor may affect the Matrix Metering. Use Center-Weighted Metering (with AEL button or manual exposure mode).
- PK-1, PK-11, BR-4 and K1 Rings cannot be mounted directly on AF Nikkor lenses.
- Polarizing filters cannot be used for autofocus or auto exposure; use a circular polarizing filter.
- Special filters, such as soft focus filters, cannot be used for autofocus or for manual focus with electronic focusing confirmation.

CAMERA CARE TIPS

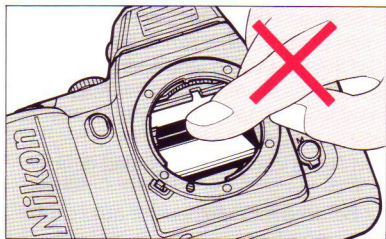

1. Never touch the reflex mirror, focusing screen or AF contacts. Remove dust with a blower brush.

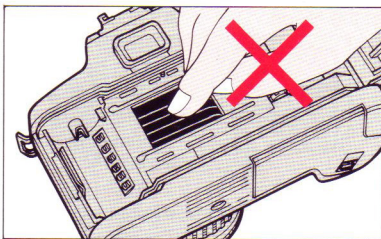

2. Never touch the shutter curtains.

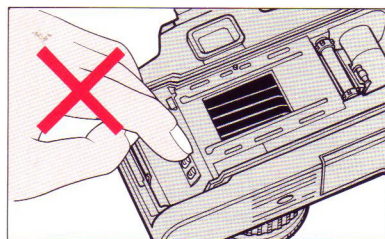

3. Never touch the DX-contacts. Keep clean with blower brush.

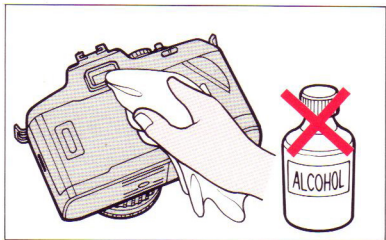

7. Clean the viewfinder eyepiece with a soft, clean cloth. Do not use alcohol.

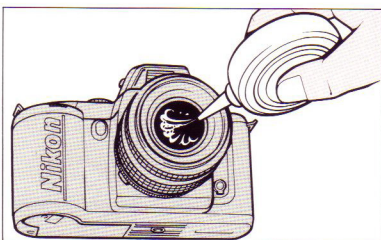

8. Clean glass surfaces such as the lens with a blower brush; avoid using lens tissue as much as possible. To remove dirt and smudges, use soft cotton moistened with pure alcohol and

wipe in a spiral motion from center to periphery. Be careful not to leave traces.

Caution

A spray gun-type blower may damage the glass if used to clean the lens, especially when ED glass is used for the front lens element. To avoid damage, hold the blower upright with its nozzle more than 30cm (12 in.) from the lens surface and keep the nozzle moving so the stream of air is not concentrated in one spot.

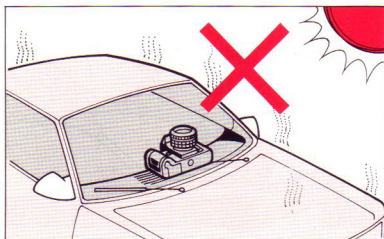

4. Do not leave the camera in an excessively hot place.



5. If the camera is exposed to rain or mist, or after shooting near the sea, wipe with a clean, soft cloth.

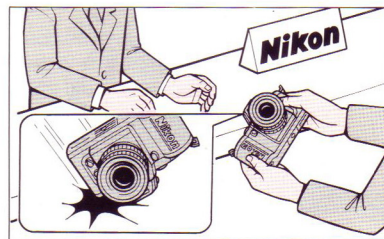

6. If the camera malfunctions, take it immediately to an authorized Nikon dealer or service center.

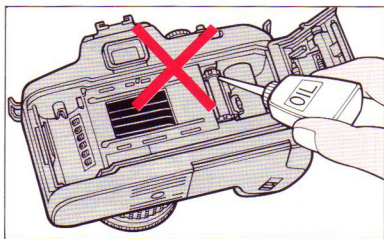

9. Do not lubricate the camera.

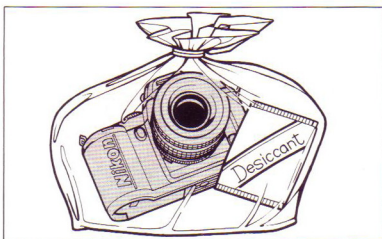

10. Store the camera in a cool, dry place away from naphthalene or camphor (moth repellents). In a humid environment, store the camera inside a vinyl bag with a



desiccant to keep out dust, moisture and salt. Note, however, that storing the leather case in a vinyl bag may cause the leather to deteriorate.

NOTES ON BATTERIES

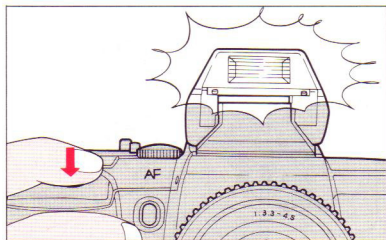

- 11.** If camera has not been used for a long time, recycling time of the built-in flash may be longer. To maintain the flash's condenser in peak condition, thereby enabling you to use the flash for many years, fire the flash a few times every month.

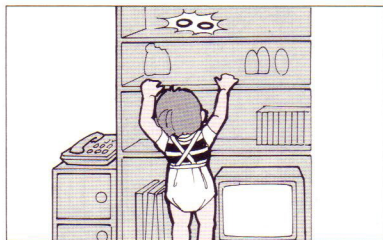

- 1.** Keep batteries out of children's reach. If swallowed, call a doctor immediately.

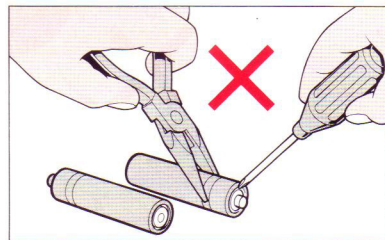

- 2.** Never disassemble, short-circuit or heat batteries.

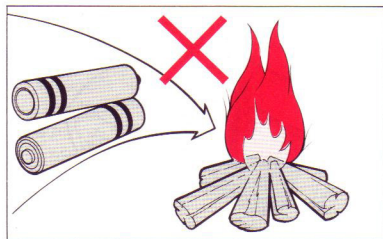

- 6.** Do not throw used batteries into a fire.



- 7.** If battery chamber is contaminated by battery leakage, take the camera to an authorized Nikon dealer.

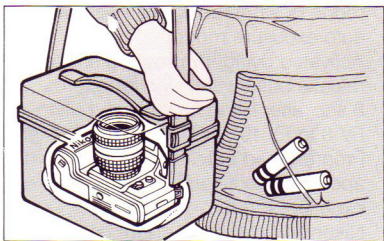

- 3.** Battery power falls off in extremely low temperatures — make sure batteries are new and keep the camera wrapped in something warm.

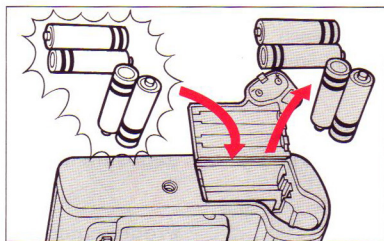

- 4.** When replacing batteries, be sure to replace all batteries at the same time. Always use fresh batteries of the same brand.

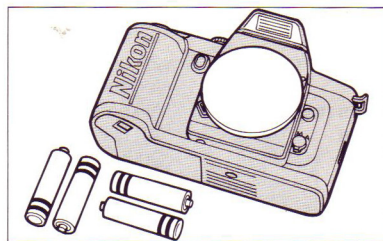

- 5.** When not using the camera for a long period, remove batteries.

Compared with regular batteries, NiCd batteries provide greater efficiency at low temperatures. Before charging NiCd batteries, thoroughly read the instructions for batteries and battery charger.

Eyepiece cover	Model DK-5 prevents stray light from entering viewfinder	Self-timer	Electronically controlled; approx. 10 sec. exposure delay; blinking LED indicates self-timer operation; two-shot self-timer is possible; cancellable
Focusing screen	Nikon BriteView screen with central focus brackets for autofocus operation	Reflex mirror	Automatic, instant-return type
Viewfinder information	Green focus indicator LED for focusing, red exposure indicator LED shows over- and underexposure warning, and correct exposure; red flash ready-light for flash photography	Camera back	Hinged back; film cartridge confirmation window and film advance indicator
Auto exposure lock	Available via pressing the AEL button while the meter is on (Center-Weighted Metering selected when the AEL button is pressed)	Accessory shoe	Standard ISO-type with hot-shoe contact, ready-light contact, TTL flash contact, monitor contact
Film speed range	ISO 25 to 5000 for DX-coded film	Built-in TTL flash	Guide number: 12 (meters) or 39 (feet) at ISO 100 and 20°C; angle of coverage: 28mm lens or longer; Matrix
Film speed setting	Automatically set by DX-coded film (ISO 100 is automatically set for all non-DX-coded films)	Flash synchronization	Balanced Fill-Flash is possible in auto exposure modes; Center-Weighted Fill-Flash is possible in manual exposure mode
Film loading	Film automatically advances to frame one when shutter release button is depressed once; film advance indicator rotates to show that film is loaded and being advanced properly		In programmed auto or aperture-priority auto, shutter operates 1/125 to 1/60 sec. (or 1/[focal length] sec. with lens focal length less than 60mm); in shutter-priority auto or manual exposure mode, automatically set to 1/125 sec. when shutter is manually set at 1/125 sec. or faster; if shutter is manually set at 1/125 sec. or slower, shutter fires as set
Film advance	Film automatically advances one frame at approx. 0.4 sec. when shutter is released; film advance stops automatically at end of film roll		
Frame counter	Accumulative type; automatically reset when camera back is opened		
Film rewind	Automatically rewound by built-in motor		

Flash indication

Flash ready-light blinks when flash is recommended (scene darker than EV 10 at ISO 100, or a scene with brightness of EV 10 or higher at ISO 100 where the center portion is darker than other areas by more than EV 2) and lights up when built-in TTL flash or accessory Nikon Speedlight is ready to fire

Autofocus flash photography

Possible only with Nikon Autofocus Speedlight SB-24, SB-23, SB-22 and SB-20

Power source

Four AA-type batteries

Number of 36-exposure film rolls per set of fresh batteries (approx.)

For autofocus operation with AF Zoom-Nikkor 35-70mm f/3.3-f/4.5 lens covering the full range from infinity (∞) to the closest distance and back to infinity (∞) before each shot, at 1/125 sec. or faster shutter speed

Batteries	With AF Nikkor 35-70mm f/3.3-4.5			
	Without flash		With flash	
	at 20°C (68°F)	at -10°C (14°F)	at 20°C (68°F)	at -10°C (14°F)
AA-type alkaline-manganese (LR06)	78	20	19	4
NiCd (KR-AA)	38	22	11	6
Zinc-carbon (SUM-3)	20	5	2	—

Dimensions (WxHxD) 154 x 102 x 65 mm
or 6.1 x 4.0 x 2.6 in.

Weight (body only) Approx. 647g
or 22.8 oz.

With fresh alkaline batteries at normal temperature (20°C [68°F]).

Specifications and design are subject to change without notice.

This device complies with Part 15 of the FCC Rules. Operation is subject to the following two conditions:
(1) This device may not cause harmful interference, and
(2) this device must accept any interference received, including interference that may cause undesired operation.

This equipment has been tested and found to comply with the limits for a Class B digital device in accordance with the specifications set forth in Part 15 of the FCC Rules. If this equipment does cause interference to radio or television reception which can be determined by turning the equipment on and off, use the equipment in another location and/or utilize an electrical outlet different from that used by the receiver.

AEL (Auto Exposure Lock)

AEL is recommended for shooting small dark subjects against a bright background or for shooting dramatic sunset scenes. When AEL is used in auto exposure mode, camera automatically switches to Center-Weighted Metering.

AF illuminator

When existing light is below a certain level and the camera is set for autofocus mode, the SB-24/SB-23/SB-22/SB-20's AF illuminator turns on automatically and provides enough subject contrast to enable the N5005's autofocus system to function as though it were daytime.

Balanced fill-flash operation

A method of flash photography that keeps flash brightness in balance with the ambient light. (See "Fill-flash.") With the built-in TTL flash or Nikon-dedicated TTL-controlled Speedlights, the N5005 performs automatic balanced fill-flash, called Matrix Balanced Fill-Flash, so both subject and background are correctly exposed, to produce a well-balanced picture. (For automatic balanced fill-flash, see page 46.)

Center-Weighted Metering

In manual mode, or when the AEL button is used in auto exposure modes, the camera automatically switches to Center-Weighted Metering. This secondary metering system places special emphasis on brightness within the 12mm-diameter central area of the viewfinder, making the N5005 exceptionally versatile for a wide variety of subjects.

Depth of field

The zone of acceptable sharpness in front of and behind the subject on which the lens is focused. Depth of field can be increased by using small apertures (larger f-numbers) or short focal-length lenses, or by taking the picture from farther away. To reduce depth of field, use larger apertures (small f-number), long focal-length lenses, and/or near subjects.

DX code

Film information code printed on the film cartridge. The N5005 automatically senses the film speed (ISO 25 to 5000) of DX-coded film the instant it is loaded.

EV

Exposure Value. A number representing the available combinations of shutter speed and aperture that give the same exposure effect when the scene brightness and ISO remain the same.

At ISO 100, the combination of a one-second shutter speed and an aperture of f/1.4 is defined as EV1.

The camera's meter may be used only within EV range of the exposure meter. For example, with the N5005, exposure metering range is from EV 0 to EV 19 at ISO 100 with f/1.4 lens.

Exposure control

Programmed auto: Camera controls both shutter speed and aperture for correct exposure.

Shutter-priority auto: User selects shutter speed and camera chooses aperture for correct exposure.

Aperture-priority auto: User selects aperture and camera chooses shutter speed for correct exposure.

Manual: User select both shutter speed and aperture with the meter's recommendations for correct exposure.

Fill-flash

A method of flash photography that combines flash illumination and ambient light.

Subjects lit from behind or near a window normally appear too dark in photographs, so it is recommended you use a flash for fill-in lighting.

(See "Balanced fill-flash.")

Flash synchronization

The timing of the flash so it fires coincident with the operation of the camera's shutter.

f-number

Number that indicates brightness of film plane image.

Increasing/decreasing f-number is equivalent to opening/stopping down lens aperture. The f-number series is 1.4, 2, 2.8, 4, 5.6, 8, 11, 16, 22, 32, etc. Changing one step to the next larger number (i.e., from f/11 to f/16) decreases image brightness by 1/2; moving to nearest lower number doubles the brightness.

Guide number

The number given to a flash bulb or electronic flash unit to indicate its power. A guide number may be quoted in meters or feet, and depends on the speed of the film being used. Guide numbers quoted assuming a relatively efficient reflector surrounds the flash source, e.g., an average-sized room.

ISO film speed

The international standard for representing film sensitivity (speed with which it reacts to light). The higher the number, the greater the sensitivity, and vice versa. A film speed of ISO 200 is twice as fast as ISO 100, and half the speed of ISO 400 film.

LED

Light-Emitting Diode. For the N5005, used to provide indications inside the viewfinder and self-timer indication.

Matrix Metering system

An advanced camera light metering system using a multi-segment sensor and computer; available Nikon SLR models F-401x/N5005, F-601/N6006, F-601M/N6000, F4, F-801s/N8008s and F-801/N8008. A basic version is used with the Nikon F-401/N4004 and F-401s/N4004s models. Matrix Metering is an exclusive Nikon feature.

SLR

Single Lens Reflex. A type of camera in which you look through the camera's lens as you view through the camera finder. Other camera functions, such as light metering and flash control, also operate through the camera's lens.

TTL

Through-The-Lens. Most SLR cameras have built-in meters that measure light after it has passed through the lens, a feature that enables exposure readings to be taken from the actual image about to be recorded on film, whatever the lens' angle of view and regardless of whether a filter is used.

TTL auto flash

The camera's light sensor measures flash light, as reflected by the subject on the film and shuts off the flash when measurement indicates correct exposure. Because the sensor that controls the flash receives light through the lens, TTL auto flash can be used for bounce photography, fill-in flash, multiple flash photography, etc. An additional advantage of TTL auto flash is that you can use a wide range of aperture settings, while ensuring correct exposure.

VIEWFINDER INFORMATION

Exposure mode		Programmed auto	Shutter-priority auto	Aperture-priority auto	Manual
Focus indicator LED	● lights up	In focus			
	● blinks	Autofocus impossible			
	● disappears	Rear/front focus (shutter does not lock in manual focusing)			
Exposure indicator LEDs (without flash)	○ lights up	Correct exposure			
	○ blinks	Camera shake warning	—	Camera shake warning	—
	+ lights up	Too bright for auto exposure			Over (+1EV ~)
	- lights up	Too dark for auto exposure			Under (~ -1EV)
	+ - blink alternately	Lens aperture not set to minimum			
	+ ○ light up	—	Over (+1 ~ +1/3 EV)		
	○ - light up	—	Under (-1/3 ~ -1EV)		
Ready-light LED	⚡ blinks (before shooting)	Flash recommended (when built-in flash or external speedlight is OFF)			—
		SB-19 is set to B or B (EM)		SB-19 is set to B or B (EM)	
	⚡ disappears	Recharging (shutter does not lock with external speedlight)			
	⚡ lights up	Recharged			
		External speedlight not set to TTL		External speedlight not set to TTL	
	⚡ blinks (after shot)	Insufficient light for correct exposure			

 Shutter is locked

No reproduction in any form of this manual, in whole or in part (except for brief quotation in critical articles or reviews), may be made without written authorization from NIKON CORPORATION.

Nikon

NIKON CORPORATION

FUJII BLDG., 2-3, MARUNOUCHI 3-CHOME, CHIYODA-KU, TOKYO 100, JAPAN

PHONE: 81-3-3214-5311 **TELEX:** NIKON J22601 **FAX:** 81-3-3201-5856

Printed in Japan 9&021-AE08(S238)