

# WILSONWERKS ARCHIVES

This camera manual is for reference and historical purposes, all rights reserved.

This cover page is copyrighted material. This document may not be sold or distributed without the express consent of the publisher.

©2008-2025 wilsonwerks Llc

**NIKKOR LENSES**

EM FE FM F2

**Fisheye Lenses**

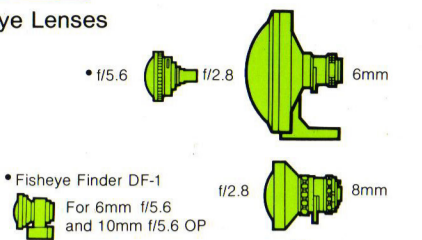

**Wideangle Lenses**

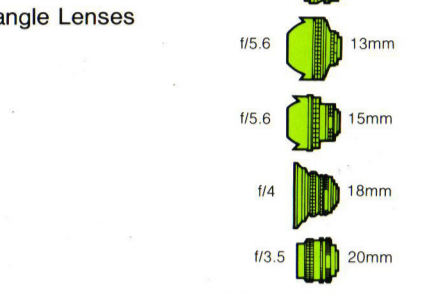

**Normal Lenses**



**Telephoto Lenses**

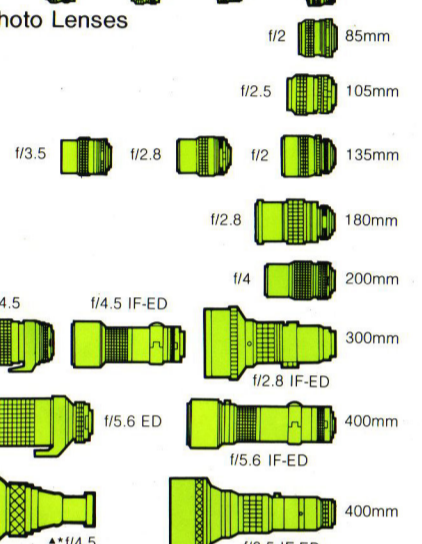

**Teleconverters**



**CLOSE UP EQUIPMENT**

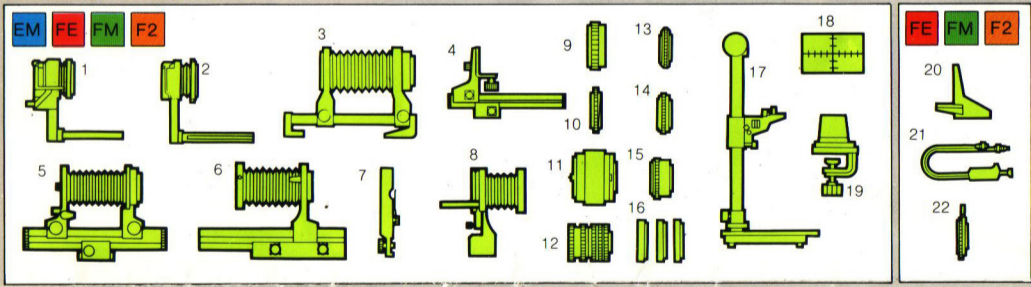

- Slide Copying Adapter PS-4
- Slide Copying Adapter PS-5
- Bellows Focusing Attachment PB-5
- Focusing Stage PG-1
- Bellows Focusing Attachment PB-6
- Extension Bellows PB-6E
- Macro Copy Stand PB-6M
- Slide Copying Adapter PS-6
- Adapter Ring BR-3
- Macro Adapter Ring BR-2
- Auto Extension Ring PN-11
- Extension Ring Set K
- Auto Extension Ring PK-11
- Auto Extension Ring PK-12
- Auto Extension Ring PK-13
- Close-up Attachment Lenses
- Repro-copy Outfit PF-3
- Gray Card
- Table Clamp PC-3
- MD Holder PH-3
- Double Cable Release AR-4
- Auto Adapter Ring BR-4

**OTHER ACCESSORIES**

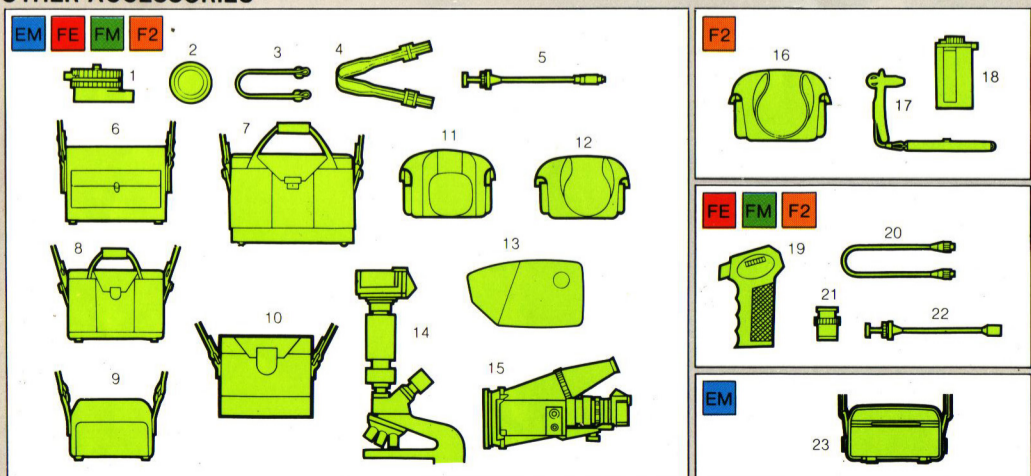

- Panorama Head AP-2
- Camera Body Cap
- Leather Neckstrap AN-1
- Nylon Neckstrap AN-4
- Shutter Cable Release AR-3
- Compartment Case FB-8
- Compartment Case FB-11A
- Compartment Case FB-15
- Compartment Case FB-14
- Compartment Case FB-16
- Soft Camera Case
- Semi-soft Camera Case
- Blimp Camera Case CS-13
- Microscope Adapter Tube Model 2
- Oscilloscope Recording Unit Model D
- Hard Camera Case
- Handstrap AH-1
- 36-Exposure Film Cassette AM-1
- Pistol Grip Model 2
- Cable Release for Pistol Grip
- Soft Shutter Release AR-1
- Shutter Cable Release AR-2
- Compartment Case FB-E

**Reflex Lenses**

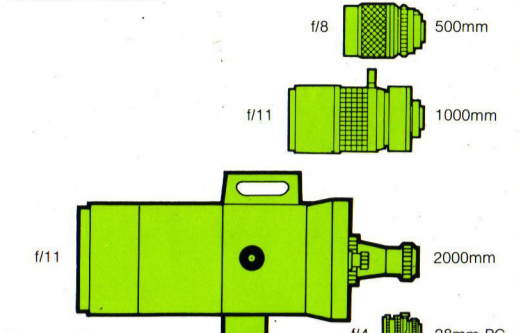

**Special Lenses**

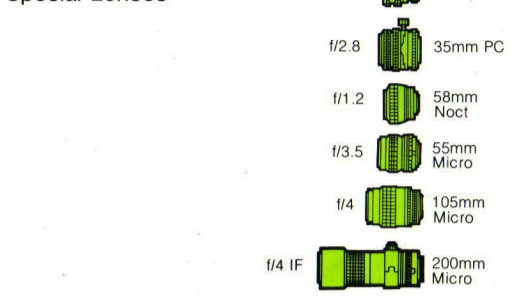

**Zoom Lenses**

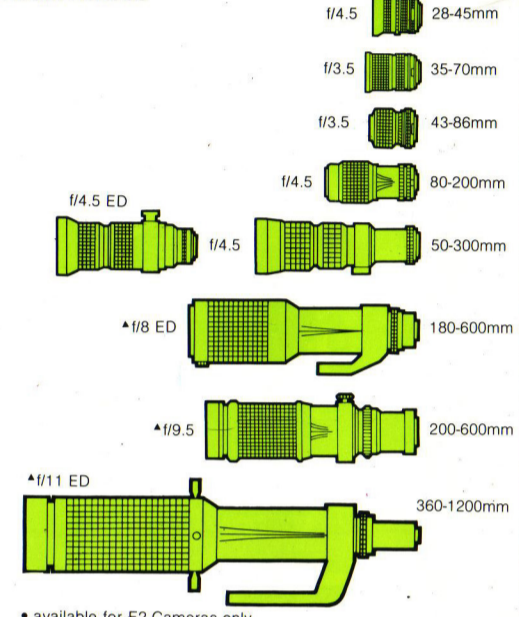

\* available for F2 Cameras only  
 \* not available for EM Camera  
 \* used with Focusing Unit AU-1

**NIKON SERIES E LENSES**

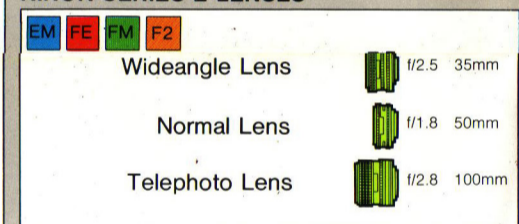

**LENS ACCESSORIES**

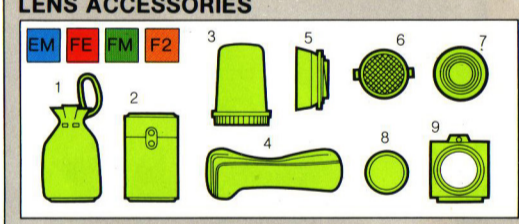

- Flexible Lens Pouch
- Leatherette Lens Case
- Plastic Lens Case
- Leatherette Camera-lens Case
- Lens Hood
- Lens Cap
- Rear Lens Cap
- Filter
- Gelatin Filter Holder



**FINDERS AND ACCESSORIES**

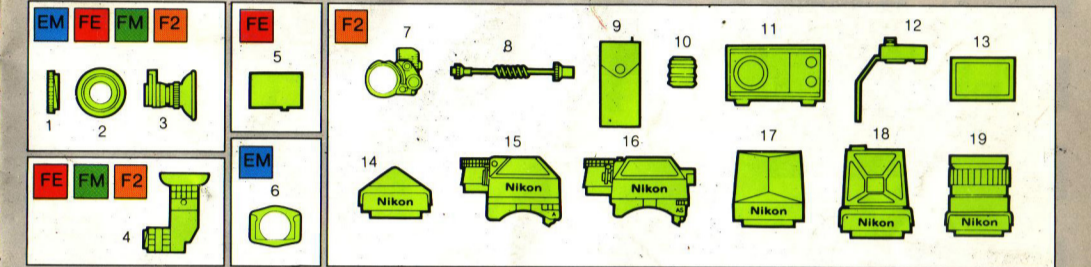

- Eyepiece Correction Lens
- Rubber Eyecup
- Eyepiece Magnifier DG-2
- Right-angle Viewing Attachment DR-3
- Focusing Screen (B, E, K)
- Eyepiece Adapter
- EE Aperture Control Attachment DS-12
- Connecting Cord DM-1
- Battery Pack DB-1 for DS-12
- NC Battery DN-1 for DS-12
- NC Battery Charger DH-1
- Photometric Illuminator DL-1
- Focusing Screen (A, B, C, D, E, G1, G2, G3, G4, H1, H2, H3, H4, J, K, L, M, P, R)
- Eyelevel Finder DE-1
- F2A Photometric Finder DP-11
- F2AS Photometric Finder DP-12
- Action Finder DA-1
- Waist-level Finder DW-1
- 6X Focusing Finder DW-2

**MOTOR DRIVES AND REMOTE CONTROL ACCESSORIES**

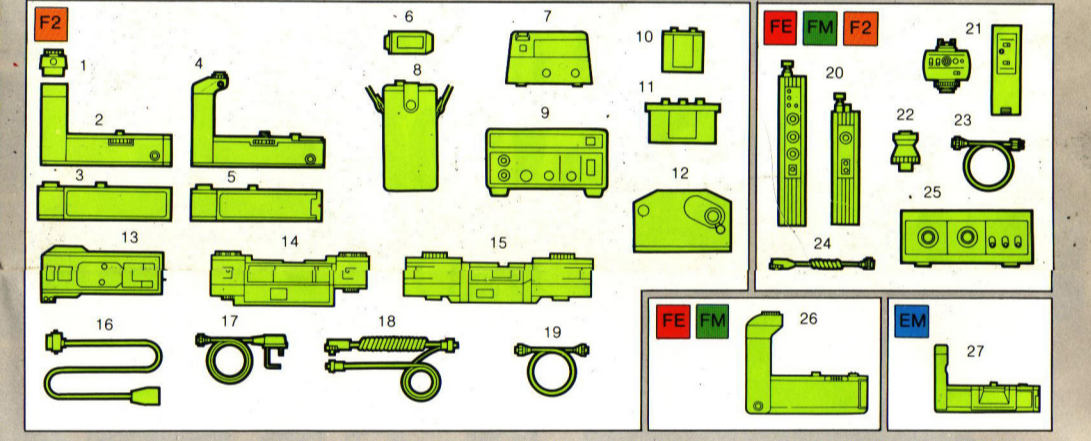

- Grip Head SC-2
- Motor Drive MD-2
- Cordless Battery Pack MB-1
- Motor Drive MD-3
- Cordless Battery Pack MB-2
- NC Battery MN-1
- NC Battery Charger MH-1
- Battery Jacket MA-3
- AC/DC Converter MA-4
- 250-Exposure Film Cassette MZ-1
- 750-Exposure Film Cassette MZ-2
- Bulk Film Loader
- Camera Back MF-3
- 250 Magazine Back MF-1
- 750 Magazine Back MF-2
- SC Remote Cord MC-1 for MD-2
- Connecting Cord for Battery Pack MC-7
- Connecting Cord for Battery Pack and Pistol Grip
- 3m Connecting Cord MC-2
- Radio Control Set MW-1
- Modlite Remote Control Set ML-1
- Terminal Shutter MR-2
- 1m Remote Cord MC-4
- Connecting Cord for Pistol Grip MC-3
- Intervalometer MT-1
- Motor Drive MD-12
- Motor Drive MD-E

**FLASH UNITS & ACCESSORIES**

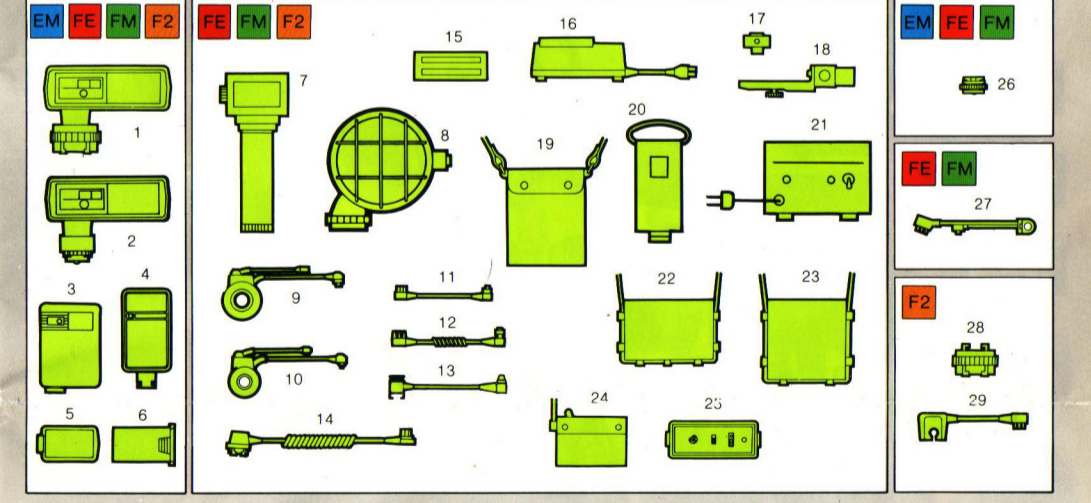

- Speedlight Unit SB-7E
- Speedlight Unit SB-10
- Speedlight Unit SB-9
- Speedlight Unit SB-E
- Wide-flash Adapter SW-2
- Battery Holder MS-2 (for SB-7E & 10)
- Speedlight Unit SB-5
- Repeating Flash Unit SB-6
- Ringlight Unit SR-2
- Macro Ringlight Unit SM-2
- Sync Cord SC-5, SC-7
- Coiled Sync Cord SC-6
- Sync Cord SC-10 for SB-9
- Extension Cord SC-9 for SU-1
- NC Battery SN-2 for SB-5
- NC Battery Charger SH-2
- Sensor Unit SU-1
- Bracket SK-3 for SB-5
- Battery Pack SD-4 for SB-5
- NC Battery SN-3 for SB-6
- NC Battery Charger SH-3
- AC Unit SA-3 for SB-6
- Battery Pack SD-5 for SB-6
- Battery Pack for Ringlights
- AC Unit for Ringlights
- Flash Unit Coupler AS-2
- Eyepiece Pilot Lamp SF-1
- Flash Unit Coupler AS-1
- Ready Light Adapter SC-4

**F2 DATA CAMERA BACKS & ACCESSORIES (for F2 Data Cameras only)**

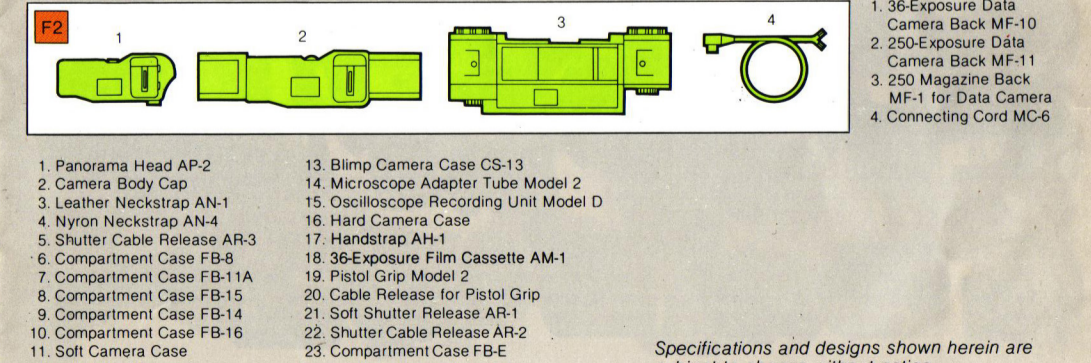

- 36-Exposure Data Camera Back MF-10
- 250-Exposure Data Camera Back MF-11
- 250 Magazine Back MF-1 for Data Camera
- Connecting Cord MC-6
- Panorama Head AP-2
- Camera Body Cap
- Leather Neckstrap AN-1
- Nylon Neckstrap AN-4
- Shutter Cable Release AR-3
- Compartment Case FB-8
- Compartment Case FB-11A
- Compartment Case FB-15
- Compartment Case FB-14
- Compartment Case FB-16
- Soft Camera Case
- Semi-soft Camera Case
- Blimp Camera Case CS-13
- Microscope Adapter Tube Model 2
- Oscilloscope Recording Unit Model D
- Hard Camera Case
- Handstrap AH-1
- 36-Exposure Film Cassette AM-1
- Pistol Grip Model 2
- Cable Release for Pistol Grip
- Soft Shutter Release AR-1
- Shutter Cable Release AR-2
- Compartment Case FB-E

Specifications and designs shown herein are subject to change without notice.

Nikon

