

# WILSONWERKS ARCHIVES

This camera manual is for reference and historical purposes, all rights reserved.

This cover page is copyrighted material. This document may not be sold or distributed without the express consent of the publisher.

©2008 wilsonwerks Llc



**OLYMPUS**



**OLYMPUS  
OM-2**

**INSTRUCTIONS**



Rewind Release Lever (P. 11)

Shoulder Strap Eyelet

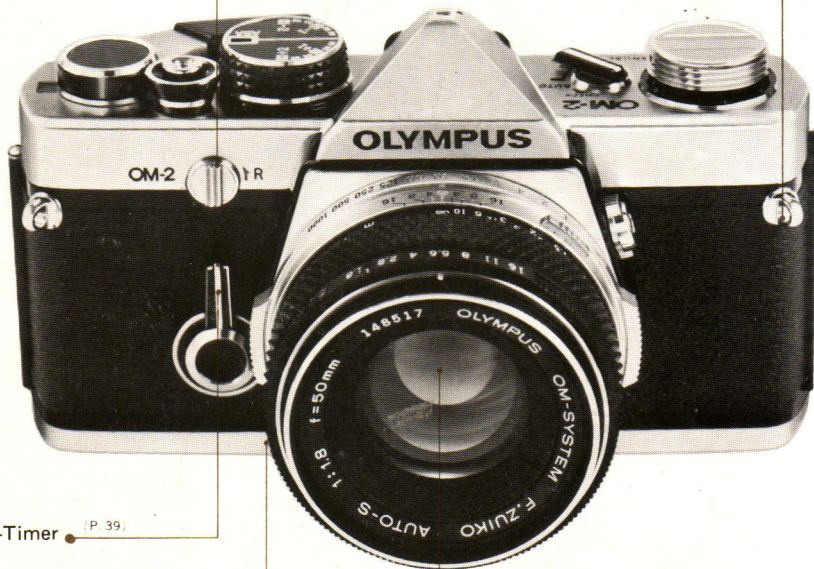

Self-Timer (P. 39)

Preview Button (P. 23)

(P. 22) Standard Lens

# OLYMPUS OM-2 DESCRIPTION OF CONTROLS

The design of the OM-2 lets you see every camera control from the top.

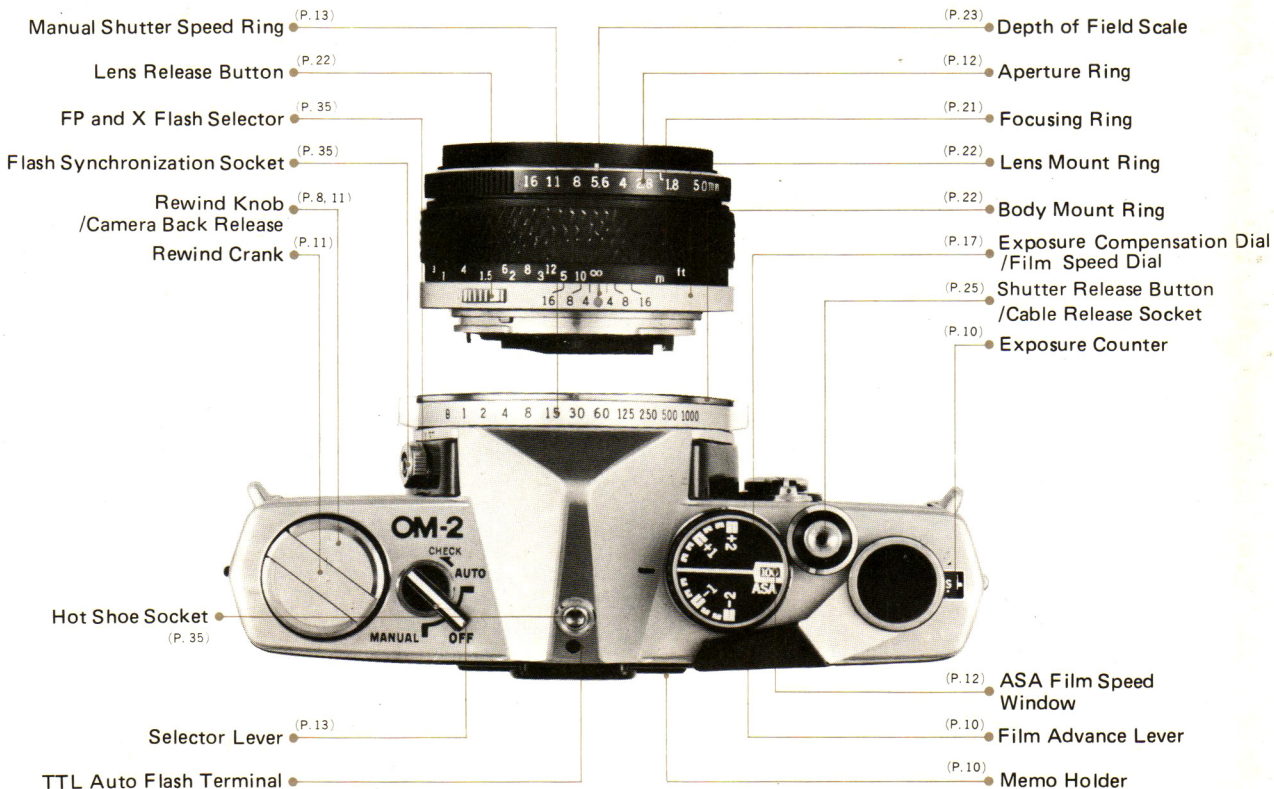

For easy reference, keep this page unfolded while you are reading the instructions on the following pages.  
The OM-2 camera body is illustrated with the 50mm F1.8 standard lens.

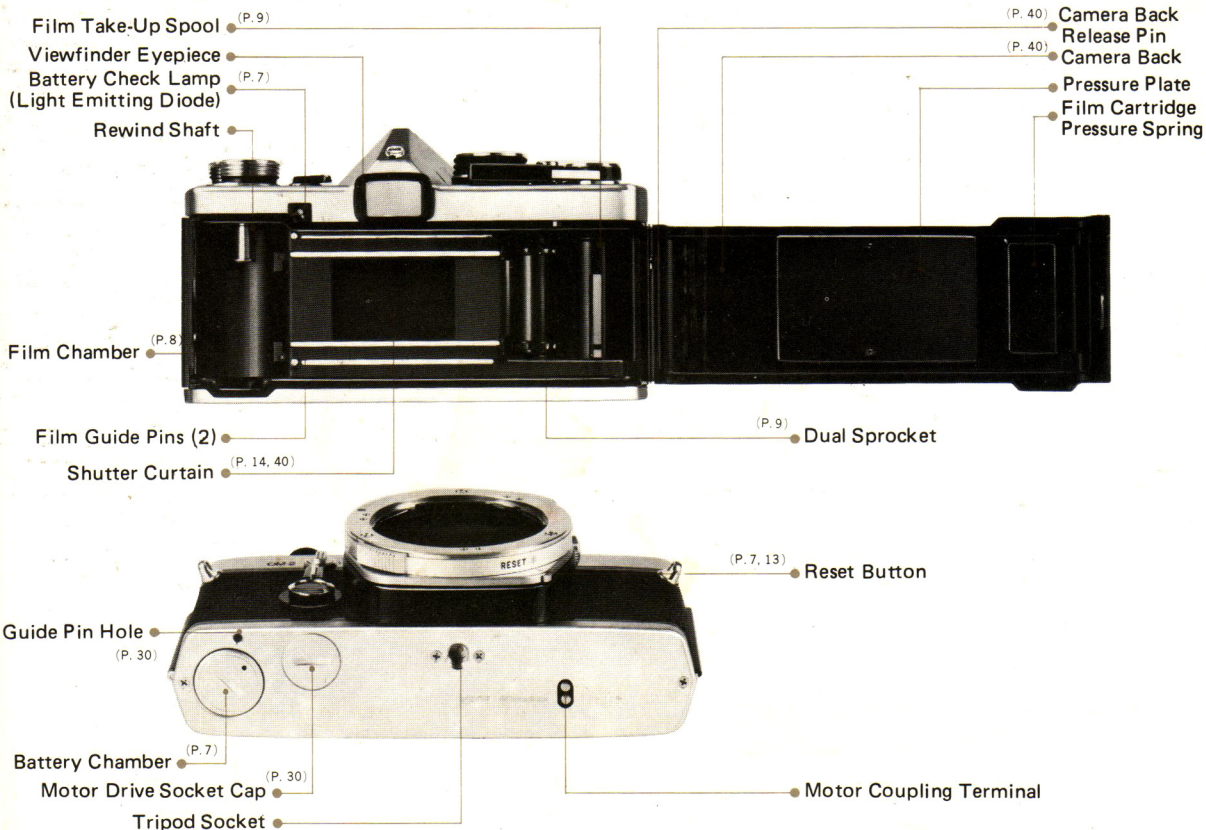



Your new OM-2 camera body is the center of the OLYMPUS OM SYSTEM — the 35mm SLR camera system which has brought new meaning to reliability, versatility, and portability in the demanding world of the modern photographer. Whether you are professional or amateur, visionary or scientist, the extensive OM System is designed to enable you to capture life as it happens from photomicrography to astrophoto-



graphy, from photojournalism to portraits.

This remarkably compact, lightweight, and functionally-designed camera body incorporates an electronic shutter and fully automatic exposure control plus manual exposure control at the flip of a lever.

Familiarize yourself with the OM-2 and the many accessories available to enhance your picture-taking capabilities.

## On OM-2

- Description of Controls . . . . . 1
- Short Course of Instructions . . . . . 5
- Inserting the Batteries . . . . . 7
- Check the Batteries. . . . . 7
- Loading the Film . . . . . 8
- Operating the Film Advance Lever 10
- The Exposure Counter . . . . . 10
- Unloading the Film. . . . . 11
- Setting the ASA Film Speed Dial . 12
- Setting the Aperture Ring . . . . . 12
- Setting the Manual Shutter  
Speed Ring . . . . . 13
- Selector Lever. . . . . 13
- Light Measuring System . . . . . 14
- Automatic Exposure Control . . . 15
- Exposure Compensation for  
Automatic Measurement  
in Special Situations . . . . . 17
- Manual Exposure Control . . . . . 19

- Focusing . . . . . 21
- Mounting the Lens . . . . . 22
- Infrared Photography / Depth of  
Field Scale / Preview Button . . . 23
- Depth of Field . . . . . 24
- Holding the Camera . . . . . 25
- Interchangeable Focusing Screens 26
- Motor Drive Photography . . . . . 27
- Operation of Winder 1 . . . . . 28
- Operation of Basic Motor Drive  
Package . . . . . 30
- Flash Photography . . . . . 33
- Operation of Quick Auto 310 . . 35
- Operation of Flash Units Other  
Than Quick Auto 310 . . . . . 37
- Operation of Flash Bulbs . . . . . 38
- Setting the Self-Timer . . . . . 39
- Changing the Camera Back. . . . . 40
- Care and Storage . . . . . 40
- Questions & Answers. . . . . 41

## On OM System

- Zuiko Interchangeable Lens  
Group . . . . . 43
- Table of Interchangeable Lenses . 45
- Interchangeable Lens Group  
Units. . . . . 47
- Motor Drive Group . . . . . 48
- Motor Drive Units . . . . . 51
- Finder Group and Units . . . . . 53
- Flashphoto Group . . . . . 55
- Flashphoto Units . . . . . 58
- Macrophotography Group . . . . . 61
- Macrophotography Units . . . . . 64
- Photomicrography Group . . . . . 69
- Photomicrography Units. . . . . 72
- Chart of Photographic Ranges. . . 74
- Phototechnical Group . . . . . 75
- Phototechnical Units . . . . . 78
- Case Group and Units . . . . . 79
- Main specifications . . . . . 82



The OM-2 can start functioning only after loading the batteries. If you release the shutter without loading the batteries, this shutter is locked and the field of view becomes dark, stopping all the functions. (See page 7 to reset the shutter.)

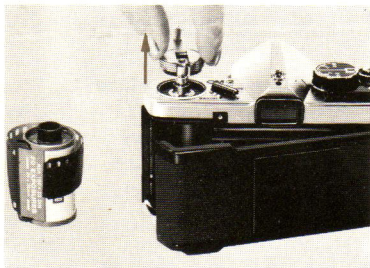

1 Load the camera (page 8).

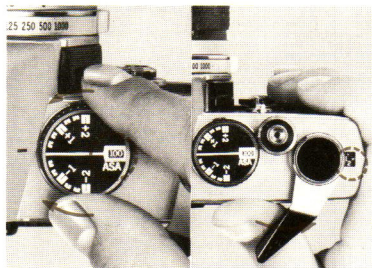

2 Set the ASA film speed dial (page 12) and advance the film until the figure "1" appears in the exposure counter window (page 10).

3

### AUTOMATIC EXPOSURE

Set the selector lever to the "AUTO" position (page 13).

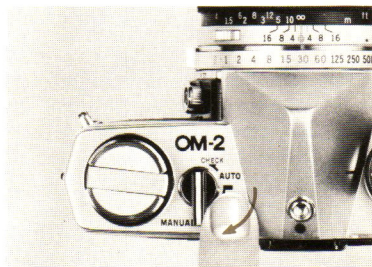
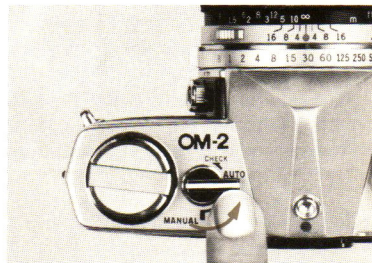

3

### MANUAL EXPOSURE

Set the selector lever to the "MANUAL" position (page 13).

#### 4 AUTOMATIC EXPOSURE

Pre-select the lens aperture and look through the viewfinder to compose your picture and focus

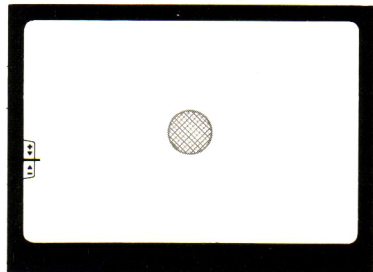
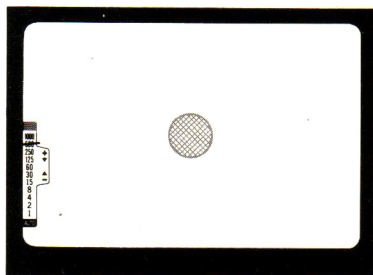

on your subject (page 15). Make sure the shutter speed scale is visible in the viewfinder.

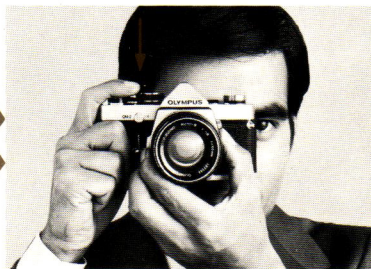

5 Hold the camera steady and press the shutter release button with a slow steady pressure to take the picture (page 25).

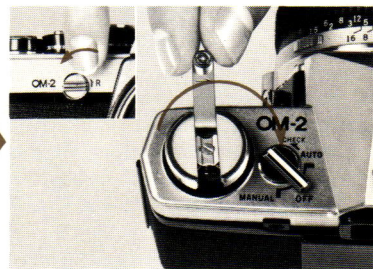

6 After the entire roll of film has been exposed, rewind the film back into the cartridge (page 11) and unload your camera.

#### 4 MANUAL EXPOSURE

Look through the viewfinder, compose your picture, focus on your subject, and determine the proper exposure (page 19). Make

sure the over- and under-exposure index marks are visible in the viewfinder.

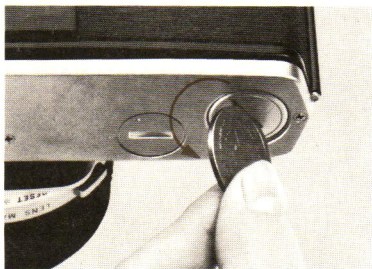

The OM-2 requires two 1.5V silver oxide batteries as a power source for both manual through-the-lens exposure measurement and automatic exposure control. The batteries must be inserted correctly or the camera will not operate.

- ① Remove the battery chamber cap by turning it counter-clockwise with a coin.
- ② Insert two 1.5V silver oxide batteries (Eveready or UCAR S-76 or equivalent) into the battery chamber making sure that each positive (+) side is facing out as shown on the diagram inside the chamber.
- ③ Replace the cap by turning it clockwise until it is tight.



**\* IMPORTANT:** If you press the shutter release button when the batteries are completely drained or when there are no batteries in the camera, the mirror will lock-up and the camera will not operate. If this occurs, follow the "RESET" Procedure to unlock the mirror and make the camera operational before loading new batteries.

#### ,"RESET PROCEDURE"

\* If the mirror is up and the shutter is locked, press the "RESET" button at the lower left corner of the body mount, and rotate the manual shutter speed ring until the reset mark (\*) is aligned with the red triangle on the lens mount. Then the mirror comes down, and the shutter is unlocked.

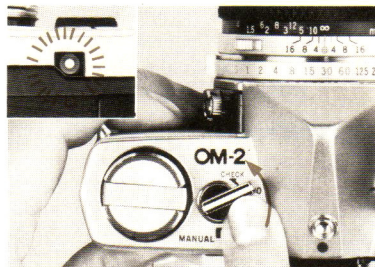

To check the batteries, move the selector lever to the "CHECK" position. The battery check lamp indicates battery condition as follows:

- ① The red lamp lights brightly — Battery voltage is sufficient.
- ② The red lamp flashes on and off — Batteries are very weak. Fresh batteries are recommended.
- ③ The lamp does not light — Batteries are drained. Replace them.



\* Silver oxide batteries will last approximately one year. When the batteries are depleted, the mirror will lock-up and the camera will no longer operate. When going on a trip, it's a good idea to take a set of fresh batteries.

\* Continuing to take pictures when the batteries are weak (battery check lamp flashes) will eventually result in mirror lock-up. Always replace weak batteries before prolonged picture-taking sessions.

If two batteries are in contact with each other when unpacked, there is a danger of short circuit. To avoid short circuit, separate them as packed in plastics provided. They can be stored in the pocket inside the top of the front cap of the hard case.

\* Even when the batteries are relatively fresh, the battery check lamp will flash in low temperatures because of battery inactivity. These batteries often return to greater power as they warm to normal temperature. Check the batteries often in low temperature conditions to make sure they are functioning properly.

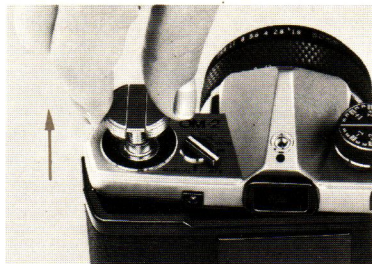

**1 Open the camera back.**

Pull the rewind knob up. A slight resistance may be felt before the camera back snaps partially open.

\* At the purchase of your OM-2, you may find a piece of paper on the film plane. Remove the paper before loading the camera.

\* Your camera uses standard 35mm cartridges of 12, 20, or 36 exposures.

Avoid direct sunlight when you load or unload the camera.

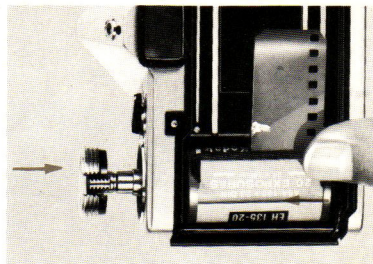

**2 Load the camera.**

Insert a film cartridge into the film chamber and push the rewind knob back into its original position. It may be necessary to turn the rewind knob slightly before it will lock securely in place.



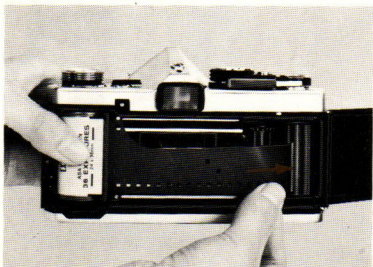

**③ Attach the film end to the take-up spool.**

Draw out the film leader and insert it into one of the slots in the film take-up spool. Make sure that the film is evenly placed between the film guide pins.

\* The take-up spool has five slots in it. Make sure the film perforation has engaged on the spool properly before closing the camera back.

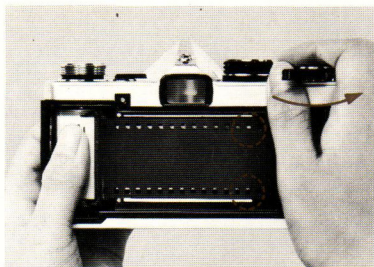

**④ Advance the film.**

Advance the film using the film advance lever. Make sure that the film perforations engage on the sprockets on both sides.

**⑤ Close the camera back until it clicks into place.**

**⑥ Tighten the film.**

After closing the back, fold out the rewind crank and turn it clockwise slowly until you feel a slight resistance. This will take up any slack in the film.

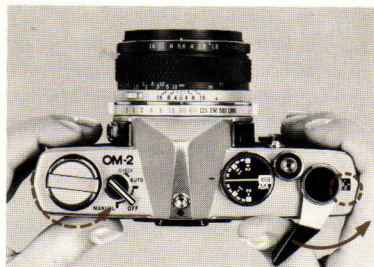

**⑦ Check the exposure counter.**

Advance the film and press the shutter release button. Continue advancing the film until "1" appears in the exposure counter window.

\* While advancing the film, the rewind knob rotates in a counter-clockwise direction indicating that the film is advancing properly.

\* During the repetition of preliminary film advance, always set the selector lever to the "OFF" or "MANUAL" position to avoid unnecessary battery drain.

## OPERATING THE FILM ADVANCE LEVER

Refer to page 27 for Motor  
Drive Photography.

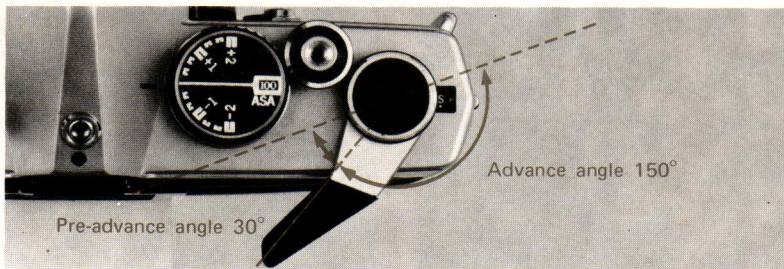

① Gently pull the film advance lever away from the camera body.

② Advance the lever to the right as far as it will go. This can be accomplished in a single stroke or in multiple short strokes.

\* Avoid touching the rewind release lever while advancing the film to make sure the film advance mechanism operates smoothly and without interruption.

\* In one full stroke, the film advance lever ① advances the film one full frame, ② advances the exposure counter, ③ cocks the shutter, ④ sets the instant return mirror, ⑤ activates the automatic diaphragm mechanism, and ⑥ activates the double advance and double exposure prevention mechanism.

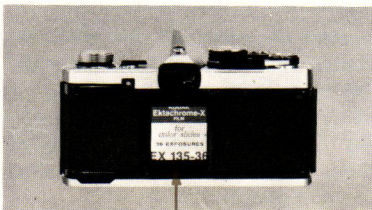

### ■ THE MEMO HOLDER

A memo holder is provided on the camera back of the camera to provide a convenient reminder of the type of film being used. The holder is designed to

## THE EXPOSURE COUNTER

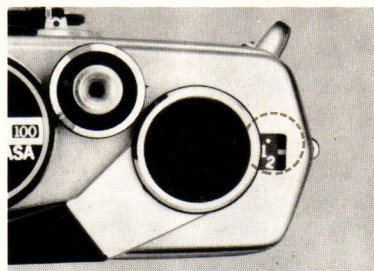

The exposure counter is designed to indicate the total number of frames exposed on the film. Each time the film is advanced by the film advance lever, the exposure counter automatically adds one frame to the total. The counter is indexed in even numbers up to 36 plus "S" (Start) and "E" (End). For easy reference, "S", "E", and numbers "12", "20", and "36" are indicated in gold. Whenever the camera back is opened, the exposure counter automatically returns to "S".

accept the end flap from most 35mm film packages, which can be inserted in the holder at the bottom as shown in the photo.



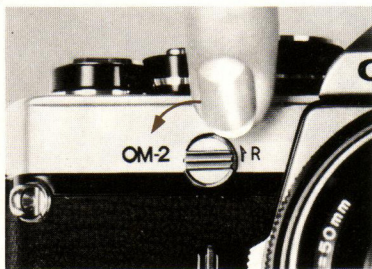

When the entire roll of film has been exposed (indicated by the numbers "12", "20", or "36" on the exposure counter depending upon the film length), rewind the film.

① Turn the rewind release lever counter-clockwise until the red dot points towards the "OM-2" marking.

#### ■ MAKING MULTIPLE EXPOSURES

Should you wish to make more than one exposure on the same frame:

① After the first exposure, take up any slack in the film by slowly turning the rewind knob in a clockwise direction until it stops.

② Turn the rewind release counter-clockwise until the red dot points towards the "OM-2" marking.

③ Hold both the rewind knob and rewind release lever to prevent them

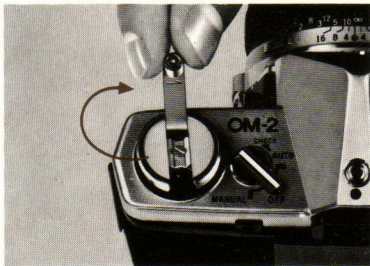

② Fold out the rewind crank and wind it in the direction of the arrow. While rewinding, you will feel tension. When the tension stops and the crank turns freely, the film has been completely rewound back into the cartridge.

from turning and advance the film advance lever. The shutter will then be cocked for the next exposure without advancing the film.

④ Press the shutter release button with a slow, steady pressure.

⑤ The film counter will advance with each exposure.

⑥ After completing the multiple exposures, put the lens cap on your lens, advance the film, and shoot a blank

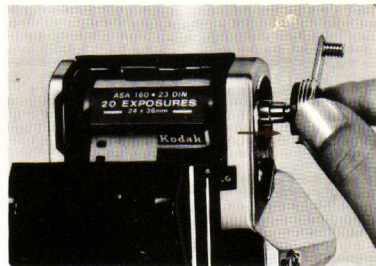

③ Open the camera back by pulling up on the rewind crank and remove the film cartridge. Keep camera and film out of direct sunlight while unloading.

\* The rewind release lever will automatically return to the original position with movement of the film advance lever when reloading with film, etc.

\* Do not force the film advance lever if the film has been fully exposed. If you feel any resistance in advancing the film, rewind the film to prevent tearing.

frame to avoid overlapping.

\* You can make as many multiple exposures as you like by repeating the above procedure. With each exposure on the same frame, the possibility of slippage is increased. Practice is required to obtain good results.

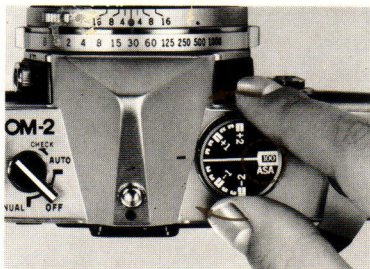

Setting the correct ASA film speed on the camera is one of the most important factors in obtaining properly exposed pictures. To set the dial:

- ① Lift up the outer collar of the exposure compensation dial and rotate until the ASA speed for the film you are using appears in the dial window.
- ② Release the collar to lock the film speed setting.
- ③ Once the setting has been made, turn the dial until the white line is aligned with the black index line on the pentaprism housing.

\* Make certain you align the white line with the black index line on the pentaprism after setting ASA.

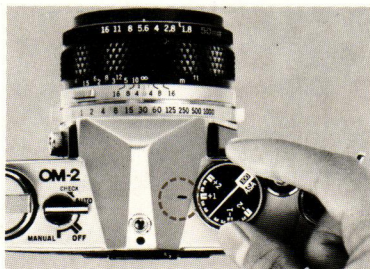

\* The ASA film speed scale on the dial is marked from 12 to 1600 in increments of 1/3 stops. In some circumstances, you may not be able to rotate the outer collar to the desired ASA in one turn of the dial (only 3 stops can be rotated in one turn of the dial). If you encounter some resistance when rotating the dial, release the collar and turn the exposure compensation dial several click stops in the opposite direction from the ASA you are trying to set. Then, lift the outer collar again and continue turning to the desired ASA setting. Repeat this procedure as many times as necessary until the desired ASA can be seen in the dial window. Finally, repeat Step ③, above. **NEVER FORCE THE DIAL WHEN SETTING ASA.**

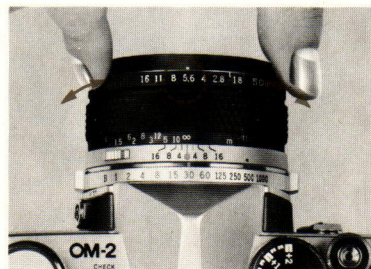

The opening in the lens diaphragm is controlled by the aperture ring which is marked in F stops to indicate the opening size in relation to the focal length of the lens. For example, the standard 50mm F1.8 lens has an aperture ring with the F stops of 1.8, 2.8, 4, 5.6, 8, 11, and 16. The higher the F number, the smaller the lens opening (less light) and the lower the F number, the larger the lens opening (more light). Also, higher F stops provide greater depth of field than lower F stops do.

*(Continued on page 81.)*

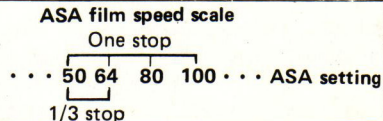





Shutter speeds engraved on the manual shutter speed ring are used only for non-automatic camera operation with zero-method exposure measurement.

These 12 shutter speeds are indicated as B, 1, 2, 4, 8 . . . . up to 1,000.

B indicates "bulb" at which setting the shutter will remain open as long as the shutter release button is held down.

The other engravings indicate fractions of a second; for example "1" for 1 second, "2" for 1/2 second . . . up to "1000" for 1/1000 second. As the numbers increase, each setting halves exposure time. As the numbers decrease, each setting doubles exposure time. Shutter speeds from 1 to 60 are indicated in blue as an easy reference for X flash synchronization.

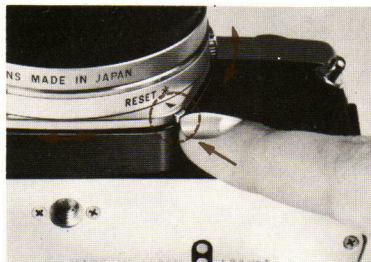

#### Manual Operation

To manually set the shutter speed, turn the selector lever to "MANUAL" and turn the shutter speed ring until the desired shutter speed clicks into place.

\* To set the shutter speed ring to position "B", turn the ring while pressing the "RESET" button at the body mount.

\* Make sure that the selector lever is set at "MANUAL" when taking time exposures on "B".

\* The manual exposure (including B) consumes the battery power.

*(Continued on page 81.)*

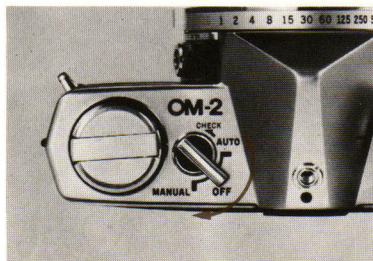

The selector lever on top of your camera has four positions:

- 1) MANUAL — Zero-method exposure operation; set shutter speed and F stop for proper exposure.
- 2) OFF — Camera turned completely off to avoid battery drain. Always store your camera with the selector lever in this position.
- 3) AUTO — Automatic exposure control; you preset lens F stop and the camera automatically sets shutter speed for proper exposure.
- 4) CHECK — Battery test position (see page 7).

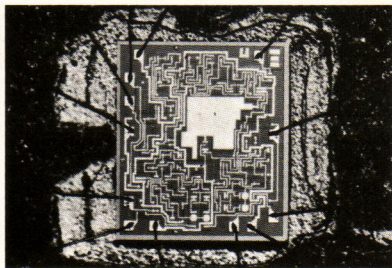
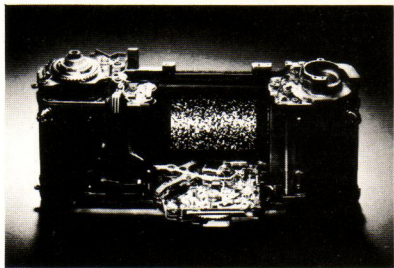
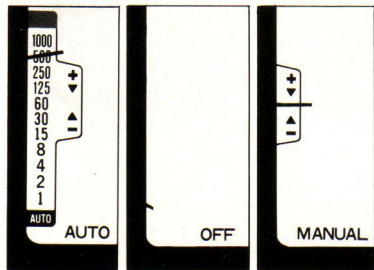

A unique feature of your OM-2, the three-position viewfinder control center, allows you to determine the operating mode of your camera without checking the position of the selector lever.

1) **AUTO** — When the selector lever is in the "AUTO" position, the viewfinder displays the complete OM shutter speed scale for "AUTO" operation, over- and under-exposure index marks, and the meter needle.

2) **OFF** — When the selector lever is in the "OFF" position, there is no display in the viewfinder.

3) **MANUAL** — When the selector lever is in the "MANUAL" position, only over- and under-exposure index marks and the meter needle are visible in the viewfinder.

\* When you are not using your camera, make sure the selector lever is set at the off position to avoid unnecessary battery drain.

For both automatic and manual exposure measurement, the OM-2 utilizes open aperture metering systems which allow you to take advantage of the brightest possible viewfinder when focusing and composing your pictures.

For automatic exposure control, light entering the lens is measured directly at the film plane or at the shutter curtain by two SBCS (silicone blue cells) at the precise moment the exposure is made. When lighting conditions are bright enough to permit comparatively high shutter speeds, measurement is made at the computer-generated random digit pattern which is printed on the shutter curtain and has its own reflection different from that of the film, with emphasis at the center of the picture area. In darker lighting condi-

tions, where slower shutter speeds are required, the exposure system automatically switches to an averaging method measured at the film plane. The transition between the two methods of light measurement takes place automatically when lighting conditions call for shutter speeds between 1/15 second and 1/60 second.

When exposure is manually set, light is measured by two highly sensitive CdS cells positioned on each side of the viewfinder eyepiece. These cells measure the actual amount of light entering the lens, placing the greatest emphasis on the center of the picture area at full aperture. This "zero-method" system for manual exposure control works with all OM System Lenses except for a few special purpose lenses.



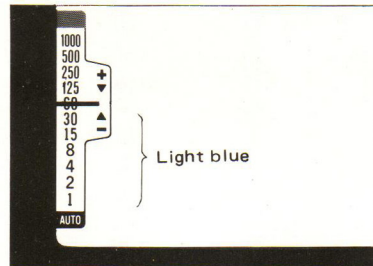
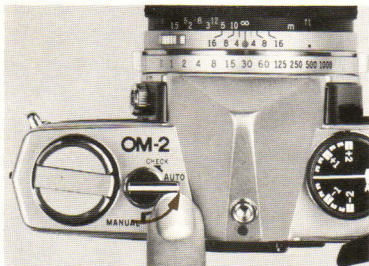

### ■ The Aperture-Preferred System

Your OM-2 utilizes an aperture-preferred automatic exposure control system which determines the optimum shutter speed for proper exposure when you pre-select the F stop. The aperture-preferred system is the most convenient-and-easy-to-use method of automatic operation, particularly outdoors when using standard or wide-angle lenses. To use this system:

1 Set the selector lever to the "AUTO" position making sure that the lever "clicks" into place.

2 Set the F stop you wish to use on the lens aperture ring.

The F stop you use, for example, should be based on your depth of field requirements (see page 24).

3 After the F stop has been set, the camera will automatically determine the shutter speed required for proper exposure and indicate that speed on the shutter speed scale display in the viewfinder.

\* At shutter speeds slower than 1/30 second, the possibility of camera movement during exposure is increased, even with standard lenses. Since camera movement can result in blurred pictures, shutter speeds from 1/30 to 1 second on the shutter speed scale are marked in light blue. If the needle in the viewfinder indicates a shutter speed in this area, turn the aperture ring until the needle moves up to the black shutter speed scale or make sure your camera is being held steady on a tripod or other stable support to assure sharp, clear photographs.

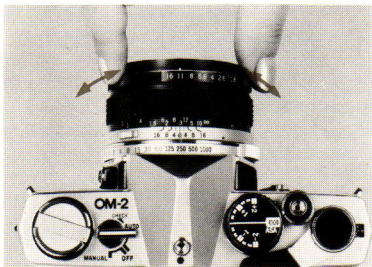

### ■ The Shutter Speed-Preferred System

Should you wish to select a shutter speed to meet a specific photographic situation (e.g., stopping fast action or eliminating camera movement), you may use a shutter speed-preferred method of automatic exposure control. To use this system:

- ① Set the selector lever to the "AUTO" position making sure that the lever "clicks" in place.
- ② Look through the viewfinder and turn the aperture ring until the viewfinder needle points at the desired shutter speed on the shutter speed scale.
- ③ Release the shutter. Your OM-2 makes precise exposure adjustments automatically.

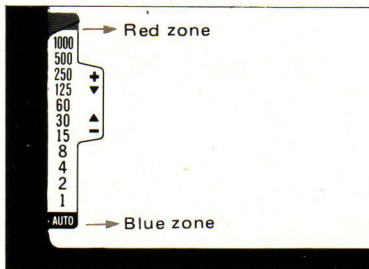

### ■ Red Shutter Speed Warning Zone

If the viewfinder needle enters the red zone at the top of the shutter speed scale, a shutter speed faster than 1/1000 second is required for proper exposure. Since this is beyond the range of your OM-2 and an over-exposed photograph would result, turn the lens aperture ring to a higher F stop number until the meter needle drops down to a shutter speed of 1/1000 second or slower.

### ■ Blue Shutter Speed Warning Zone

If the viewfinder needle enters the blue "AUTO" zone, a shutter speed longer than 1 second is required for proper exposure. Since your OM-2 provides for automatic exposures from 1 second to approximately 60 seconds (with ASA 100), make sure your camera is on a tripod or other stable support.

### ■ Shutter Speed Limitations with Different Focal Length Lenses

The longer the focal length of a lens, the greater the possibility of camera shake at a given shutter speed when hand-holding the camera. For the sharpest possible pictures, use the table below to determine the minimum shutter speed requirement for hand-held photos:

- ① Wide-angle and super wide-angle lenses — 1/30 second or faster.
- ② Standard lenses — 1/60 second or faster.
- ③ Telephoto and Zoom lenses to 100mm — 1/125 second or faster.
- ④ Telephoto and Zoom lenses to 200mm — 1/125 second or faster.
- ⑤ Super telephoto lenses of 300mm and up — 1/500 second or faster

\* Your camera provides automatic exposure control when using extension tubes or auto bellows. However, meter readings must be taken with the camera lens stopped down to shooting aperture.

\* If you wish to close the shutter during a long time exposure under AUTO operation, turn the selector lever to the OFF position, and the shutter closes.

*(Continued on page 81.)*



# OLYMPUS OM-2 EXPOSURE COMPENSATION FOR AUTOMATIC MEASUREMENT IN SPECIAL SITUATIONS

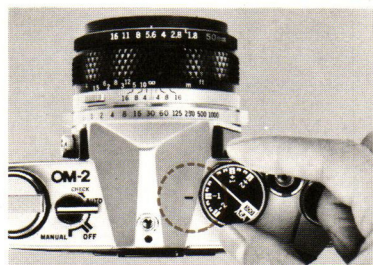
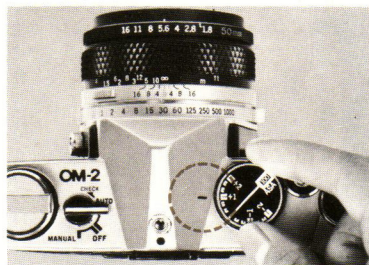
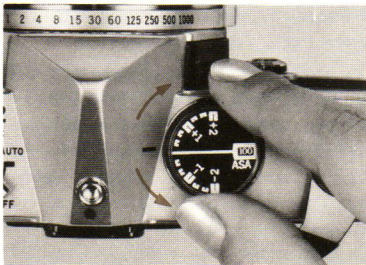

Should you wish to alter the exposure setting automatically selected by the camera, to compensate for unusual lighting conditions or create special effects, use the exposure compensation dial located on top of your camera.

**TO INTENTIONALLY OVER-EXPOSE**, turn the dial to the plus (+) side. The +1 and +2 engravings on the dial represent 1 and 2 full F stops of over-exposure.

**TO INTENTIONALLY UNDER-EXPOSE**, turn the dial to the minus (-) side. The -1 and -2 engravings represent 1 and 2 full F stops of under-exposure.

\* Each full F stop engraved on the exposure compensation dial is divided into three click-stop positions. The

Over- and under-exposure compensations may be necessary in the following situations:

① When the main subject is much darker than the general background or when strong light strikes the subject from behind or from the side, the meter has a tendency to read the brightest part of the picture resulting in a slightly under-exposed subject. To compensate for this, turn the exposure compensation dial to the plus (+) side.

dial functions properly **ONLY** at the click-stop settings and no in-between settings can be used (see page 12).

② When taking a picture of a bright subject against a dark background (spot-lighting, deep shadows, etc.) the meter has a tendency to read the darkest part of the picture resulting in a slightly over-exposed subject. To compensate for this, turn the compensation dial to the minus (-) side.

\* After taking a picture using the compensation dial, make sure you return the dial to the normal setting by aligning the bold white line with the black index mark on the camera pentaprism.

The exposure compensation dial is provided with a bold white line on it in order to easily indicate whether the dial is engaged in exposure compensation or not.

## ■ Special Automatic Exposure Techniques

### ① Backlighting and Sidelighting

When the primary subject of your picture is much darker than the general background area, move forward until the subject fills as much of the viewfinder picture area as possible. (With a zoom lens, you may be able to do this by zooming in on the subject without changing your position.) After noting the shutter speed indicated by the needle, return to your original position, re-compose your picture, and turn the compensation dial until the shutter speed needle indicates the shutter speed obtained from the close-up meter reading.

If this procedure is not possible, you can obtain approximately the same results by simply turning the exposure compensation dial to the +1 position.

It is always a good idea to use a lens hood when there is strong backlighting or sidelighting to avoid unwanted glare.

### ② Strong Contrast or Deep Shadows in Background

When taking a picture of a bright subject against a dark background, the subject may often be over-exposed. To compensate, move forward until the subject fills as much of the viewfinder picture area as possible. (With a zoom lens, you may be able to do this by zooming in on the subject without changing your position.) After noting the shutter speed indicated by the needle, return to your original position, re-compose the picture, and turn the exposure compensation dial until the shutter speed needle indicates the shutter speed obtained from your close-up meter reading.

If this procedure is not possible, you can obtain approximately the same results by simply turning the exposure compensation dial to the -1 position.





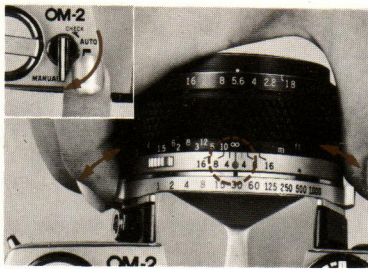

### ■ Shutter Speed-Preferred Manual Exposure Control

Should you wish to select a shutter speed (e.g., to stop fast action, eliminate camera shake, etc.), set the selector lever to the "MANUAL" position.

- ① Turn the shutter speed ring until the desired speed is opposite the red reference dot on the lens barrel.
- ② Look through the viewfinder and turn the aperture ring until the needle lines up in the center of the index. For fine exposure adjustment you can use any intermediate F stop position.
- ③ If the needle will not align properly, select a new shutter speed. To correct for over-exposure, try a faster speed; for under-exposure, try a slower speed.



### ■ Aperture-Preferred Manual Exposure Control

Should you wish to preselect the F stop (e.g., to control depth of field):

- ① Turn the aperture ring until the desired F stop is opposite the white index mark at the front of the lens barrel.
- ② Look through the viewfinder and rotate the shutter speed ring until the needle lines up as close as possible to the center of the index. Make sure that the shutter speed meets the other requirements of the situation, and that the shutter speed ring is set directly at a click-stop position and not in-between two settings.
- ③ Make the final exposure adjustment by turning the aperture ring until the needle aligns exactly in the center of the index.

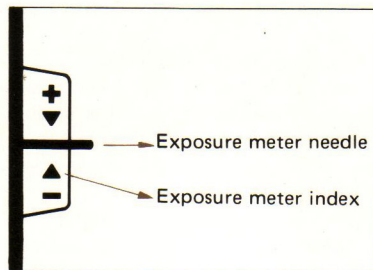

### ■ Intentional Over- or Under-Exposure

If the meter needle points to the plus (+) side of the index, the camera is set for over-exposure. If the needle points to the minus (-) side of the index, the camera is set for under-exposure.

**NOTE:** The shutter speed is not coupled with the exposure meter at the B setting. These over- and under-exposures can be used intentionally to meet special lighting conditions such as backlighting, sidelighting, etc.

### ■ Caution in Low Light Exposure

The following list summarizes the lowest measurable limit in dealing with extreme low light conditions:

ASA 100, with 50mm F1.8 lens-1/2 second at F1.8
ASA 100, with 50mm F1.4 lens-1/2 second at F1.4
ASA 100, with 50mm F1.2 lens-1/2 second at F1.2



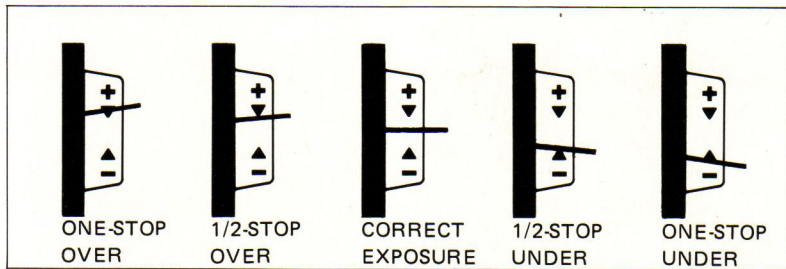

■ **If the Exposure Needle Does Not Move**

Point the camera towards a bright light source with the selector lever in the "MANUAL" position. If the needle does not move, the batteries may not be inserted, may be improperly inserted, or may be depleted. After checking the batteries re-insert them properly or replace them.

■ **If the Exposure Needle Does Not Center on the Index**

If the exposure needle will not center on the index, adjust the shutter speed or F stop until the needle is centered.

To obtain proper exposure, you may use an ND (neutral density) filter when the subject is too bright, or an electronic flash or flash bulb when the subject is too dark.

■ **Stop Down Exposure Readings**

When using the OM-2 in conjunction with extension tubes, bellows, or the Zuiko Shift Lens (under development), it is necessary to take meter readings with the lens stopped-down.

■ **Special Manual Exposure Control Techniques**

① **Backlighting and Sidelighting**

When the most important area of the picture is much darker than the general picture area (strong light hitting the main subject from behind or from the side) the meter will have a tendency to read the brightest part of the picture leaving the main subject under-exposed. To compensate for this, move forward until the subject fills most of the viewfinder picture area and set the F stop/shutter speed combination which centers the meter needle between the index marks. Return to your original position and take the picture without changing this F stop/shutter speed combination even though the needle is not centered. If this procedure cannot be followed, you can obtain approximately the same results by simply setting an F stop/shutter speed combination which causes the meter needle to indicate one full stop of over-exposure. (NOTE: With backlighting or sidelighting, it's always a good idea to use a lens hood to eliminate unwanted glare.)

*(Continued on page 81.)*



▲ In focus.



▲ Out of focus.

The OM-2 is equipped with the standard Microprism-matte Focusing Screen (1-1) which is designed for quick, easy focusing. To focus, look through the viewfinder and turn the lens focusing ring in either direction until your subject appears sharpest. The shimmering effect in the central spot of the Focusing Screen will disappear when critical focusing has been achieved.

\* You can determine the distance between the subject and the film plane by reading the distance scale on the focusing ring after you achieve critical focusing. The actual distance is indicated opposite the red central index mark on the lens mount ring; the white scale indicates this distance in meters and the orange scale indicates this distance in feet.

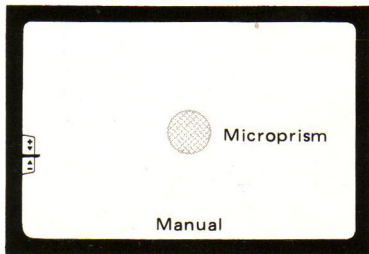
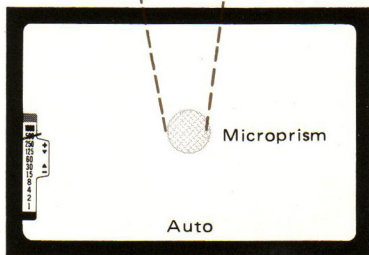

\* The OM-2 viewfinder takes in 97% of the actual picture area for added convenience, when composing your pictures.

■ Lens Nomenclature

● Lens Release (P22)  
Button

● Meter Coupling  
(P22)

● Lens Mount  
Ring (P22)

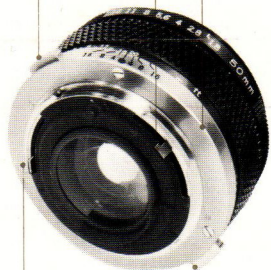

● Preview  
Button

● Automatic Diaphragm Lever

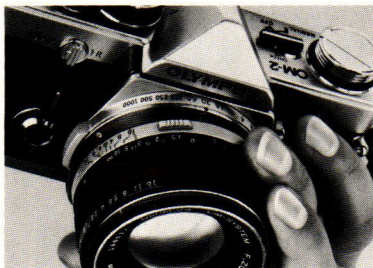

(Remove the body cap from the OM-2 by turning it counterclockwise.)

To mount the lens, grasp it firmly and align the red dots on the lens flange and the camera mount ring. Turn the lens clockwise until it locks in place. The lens release button will spring up and you will hear a positive "click" when the lens has been fully engaged.

\* Do not apply pressure to the lens release button during the mounting pro-



cedure to assure proper coupling between the lens and the meter.

To detach the lens, press down on the lens release button and turn the lens counter-clockwise.

\* Protect your lens and camera! Always attach the front and rear lens caps when the lens is removed from the body to prevent any possibility of damage. Never leave the camera body in direct sunlight with the lens removed and, if you plan to store the camera without the lens, use a body cap.

■ Front Lens Cap

To remove or attach the front lens cap, press the spring-loaded clips on both sides of the cap. The cap fits into the accessory thread of the lens. If a filter is attached, the cap will fit directly into the filter's accessory thread.





## OLYMPUS OM-2 INFRARED PHOTOGRAPHY

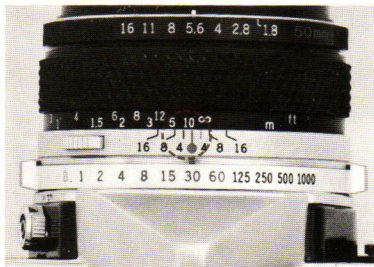

The OLYMPUS OM System Lenses are provided with an infrared index mark engraved in red on the depth of field scale to the right of the reference dot. When shooting with infrared film, focus normally on your subject without the red filter on and read the subject distance on the distance scales. Then, turn the focusing ring to the right until the distance reading is opposite the infrared index mark. Your lens will then be in focus for average infrared photography. Shoot with the red filter on. In the above picture, the red index is set at infinity.

## OLYMPUS OM-2 DEPTH OF FIELD SCALE

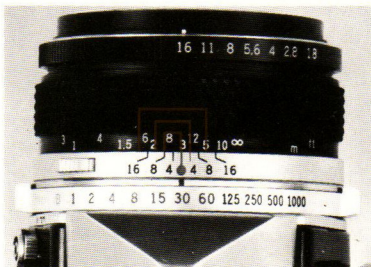

The double series of numbers engraved on the depth of field scale represents F stops: F4, F8, and F16. Once you have focused on your subject, all objects within the distance range indicated on the lens distance scale between the marks for the F stop you have selected will have acceptable sharpness.

For example, in the above picture, the camera-to-subject distance is 3m (10 feet) and the lens is set at F16. If you read the distance scale at the points opposite the engraved "16" on both sides of the reference dot, you will find that the depth of field is from 1.9m (6 feet) to 7m (23 feet). The depth of field can be visually verified by pressing the depth of field preview button and observing the image in the viewfinder.

## OLYMPUS OM-2 PREVIEW BUTTON



When you wish to see which objects fall within the acceptable zone of sharpness (depth of field), press the preview button on your lens. The diaphragm of the lens will stop down to the preset F stop enabling you to see the depth of field in the camera viewfinder.

\* If you jerk the preview button while depressing the shutter release button halfway down, the shutter might get released. Make sure you press the preview button gently to avoid accidentally releasing the shutter.

# OLYMPUS OM-2 DEPTH OF FIELD

Depth of Field Table (F1.8 & F1.4 Standard Lenses) Circle of least confusion 1/30 mm

Depth of field is the area of acceptable sharpness in front of and behind the subject in focus. This depth is determined by the F stop you have selected and the distance from the subject in focus to the film plane. As you get closer to your subject or as you open your lens (e. g. from F22 to F2.8) the depth of field becomes shallower. By stopping your lens down (e. g. from F2.8 to F22) or getting farther away from your subject this depth of field or zone of acceptable sharpness can be increased.

Another factor in determining depth of field is the focal length of your lens. As a rule the shorter the focal length, the greater the zone of acceptable sharpness. The longer the focal length, the shallower this zone becomes.

The table above shows that when the camera-to-subject distance is 3m (10ft), the depth of field at F16 ranges from 1.93m (6ft) to 6.93m (23ft).



F2 (1/1000 sec.)



F16 (1/15 sec.)

F Stop	Camera-to-Subject Distance (m), Figures with * are engraved on the distance scale.									
	* 0.45	* 0.5	* 0.7	* 1	* 1.5	* 2	* 3	* 5	* 10	* ∞
1.4	0.45 ~0.45	0.50 ~0.50	0.69 ~0.71	0.99 ~1.02	1.47 ~1.54	1.94 ~2.07	2.86 ~3.16	4.61 ~5.46	8.55 ~12.05	57.78 ~∞
1.8	0.45 ~0.45	0.50 ~0.50	0.69 ~0.71	0.98 ~1.02	1.46 ~1.55	1.92 ~2.09	2.82 ~3.20	4.52 ~5.60	8.21 ~12.79	45.05 ~∞
2	0.45 ~0.45	0.50 ~0.50	0.69 ~0.71	0.98 ~1.02	1.45 ~1.55	1.91 ~2.10	2.80 ~3.23	4.47 ~5.68	8.05 ~13.20	40.57 ~∞
2.8	0.45 ~0.45	0.49 ~0.51	0.69 ~0.71	0.97 ~1.03	1.43 ~1.57	1.88 ~2.14	2.73 ~3.33	4.28 ~6.01	7.47 ~15.15	29.02 ~∞
4	0.44 ~0.46	0.49 ~0.51	0.68 ~0.72	0.96 ~1.04	1.41 ~1.61	1.83 ~2.20	2.63 ~3.49	4.04 ~6.57	6.74 ~19.44	20.35 ~∞
5.6	0.44 ~0.46	0.49 ~0.51	0.67 ~0.73	0.94 ~1.06	1.37 ~1.66	1.77 ~2.29	2.51 ~3.74	3.75 ~7.52	5.96 ~31.31	14.55 ~∞
8	0.44 ~0.46	0.48 ~0.52	0.66 ~0.74	0.92 ~1.09	1.32 ~1.73	1.69 ~2.45	2.34 ~4.18	3.39 ~9.61	5.09 ~378.10	10.21 ~∞
11	0.43 ~0.47	0.48 ~0.53	0.65 ~0.76	0.90 ~1.13	1.27 ~1.84	1.60 ~2.68	2.17 ~4.91	3.02 ~14.74	4.30 ~∞	7.44 ~∞
16	0.43 ~0.48	0.47 ~0.54	0.63 ~0.79	0.86 ~1.20	1.19 ~2.05	1.47 ~3.17	1.93 ~6.93	2.57 ~138.43	3.42 ~∞	5.13 ~∞

F Stop	Camera-to-Subject Distance (ft), Figures with * are engraved on the distance scale.							
	* 2	* 3	* 4	* 6	* 8	* 12	30	* ∞
1.4	1.98 ~2.02	2.96 ~3.04	3.93 ~4.08	5.83 ~6.18	7.69 ~8.33	11.31 ~12.78	25.97 ~35.51	187.12 ~∞
1.8	1.98 ~2.02	2.95 ~3.05	3.91 ~4.10	5.78 ~6.23	7.61 ~8.43	11.13 ~13.01	25.02 ~37.47	146.31 ~∞
2	1.98 ~2.02	2.94 ~3.06	3.90 ~4.11	5.76 ~6.26	7.57 ~8.48	11.05 ~13.14	24.57 ~38.54	131.88 ~∞
2.8	1.97 ~2.03	2.92 ~3.08	3.86 ~4.15	5.67 ~6.37	7.41 ~8.69	10.71 ~13.66	22.91 ~43.50	94.60 ~∞
4	1.96 ~2.05	2.89 ~3.12	3.80 ~4.22	5.54 ~6.54	7.19 ~9.02	10.23 ~14.51	20.81 ~53.91	66.45 ~∞
5.6	1.94 ~2.07	2.85 ~3.17	3.72 ~4.32	5.38 ~6.79	6.91 ~9.51	9.67 ~15.85	18.54 ~79.26	47.60 ~∞
8	1.91 ~2.10	2.79 ~3.25	3.62 ~4.48	5.15 ~7.20	6.53 ~10.35	8.93 ~18.38	15.95 ~270.28	33.41 ~∞
11	1.88 ~2.13	2.72 ~3.35	3.49 ~4.69	4.89 ~7.79	6.11 ~11.64	8.15 ~23.00	13.58 ~∞	23.36 ~∞
16	1.83 ~2.20	2.61 ~3.51	3.31 ~5.09	4.52 ~9.02	5.53 ~14.70	7.12 ~39.68	10.89 ~∞	16.80 ~∞



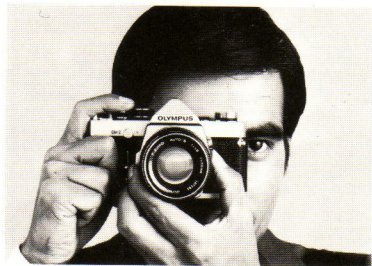

Proper camera handling is important in assuring the sharpest possible pictures. Even slight camera movement can result in "blurred" photographs. To hold the camera properly, support the camera/lens combination with most of the weight resting in the palm of your left hand, while applying your right hand to the camera's side. Transport the film advance lever with your right thumb and squeeze the release button smoothly using the cushion, not the tip, of your index finger. The aperture ring, focusing ring and shutter speed ring are so arranged as to enable you one hand operation with left fingers right up to the moment the shutter is released. Hold your breath at the moment of shutter release.

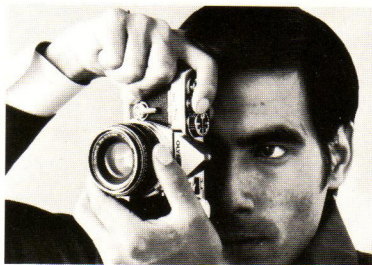

\* When holding the camera horizontally, keep both elbows close to the body.

\* For vertical shooting, keep one elbow close to your body and press the camera tightly against your forehead.

\* Steady yourself against any nearby support (such as a tree, fence, or wall) whenever possible.

\* When hand-holding a telephoto lens,

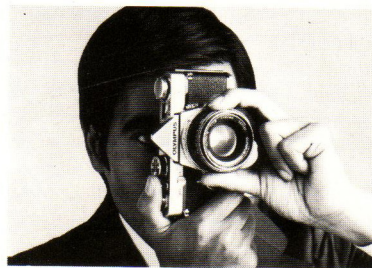

camera shake is magnified as the focal length increases. Always try to use the fastest possible shutter speed lighting conditions will allow.

\* When shooting under  $1/30$  of a second, using a stable platform or tripod with a cable release is recommended. This eliminates the possibility of jarring the camera and is particularly important with telephoto lenses.

\* For telephotography, or slow shutter speed photography, it is recommended to use a tripod and hold the camera steady with your hands.



# OLYMPUS OM-2 INTERCHANGEABLE FOCUSING SCREENS

Handle with extreme care.

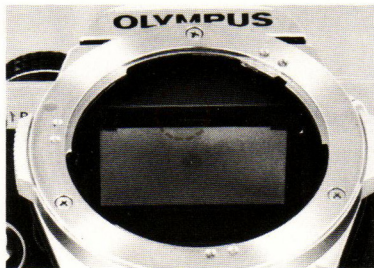

The OM System Focusing Screens provide you with the ultimate in focusing versatility. There are optional Screens available to suit virtually every picture-taking situation. The optional Focusing Screens come with a special tool. To remove the Focusing Screen:

1) Insert the tool into the camera and pull on the release catch. This allows the Screen and screen frame to drop down.

2) Using the tool, the Screen can be made to drop completely down without touching it. Remove the Screen by gripping the plastic tipped portion of the Screen between the tool's jaws with light but firm pressure.

3) For installing the Screen — reverse the above procedure.

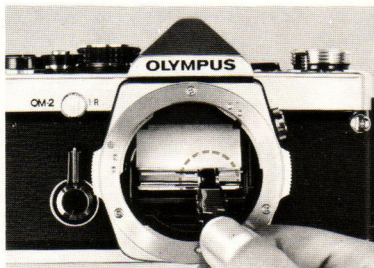

**IMPORTANT:** Although the above procedure could be done with fingers, the use of a pair of tweezers is a must, because changing Focusing Screen is a procedure to be handled with great care. Trying to change Screens with your finger can result in fingerprints and costly damage to the surface of the Screen. Should this occur, cleaning or repair **MUST** be handled by an authorized service center. Such damage is not covered by the product warranty.

\* If there is dust or dirt in the viewfinder, use an air blower to remove it. *Never* wipe the surfaces of the screens, prisms, or mirror with cloth or paper.

*(Continued on page 81.)*

# OLYMPUS OM-2 List of Optional Focusing Screens

1-1 Microprism-matte type (for most lenses)	1-7 Microprism-clear field type (for super telephoto lenses)
1-2 Microprism-matte type (for standard and telephoto lenses)	1-8 All matte type (for telephoto lenses and astronomical telescopes)
1-3 Split image-matte type (for most lenses)	1-9 Clear field type (for endoscopic photography)
1-4 All matte type (for most lenses)	1-11 Cross hairs-matte type (for close-up and macrophotography)
1-5 Microprism-clear field type (for wide angle and standard lenses)	1-12 Cross hairs-clear field type (for photomicro and macrophotography)
1-6 Microprism-clear field type (for standard and telephoto lenses)	1-13 Microprism / split image-matte type (for most lenses)

\* See page 54 for details. Specifications subject to change without notice.

Automatic exposure control makes the OM-2 ideal for use with the OM System Motor Drive Group.

The motor-driven OM-2 has many exciting applications in various fields such as sports photography, action portraits, copy work, wildlife photography, time-lapse photography, etc.

By automatically advancing the film and cocking the shutter, the motor drive allows the photographer to shoot a series of pictures that might otherwise be lost through the time-consuming manual method.

Approximately half the weight of a conventional motor drive unit, the OM System Motor Drive Group is specifical-

ly tailored to the compact size of the OM-2 body. The OM-2 with motor drive weighs slightly more than the conventional 35mm SLR camera without motor drive. In addition to its compact size and weight, the OM System Motor Drive excels in performance. The basic Motor Drive package can provide operation up to 5 frames per second at optimum\* condition for sequence operation (see right), has single frame release capability, and offers more motor drive sequence applications over a wide range of shutter speeds.

With the automatic exposure control, the motor driven shutter continuously adjusts for any changes in light to assure

correct exposure for each frame, even at the maximum rate of five frames per second. The basic Motor Drive package consists of the OM-2, Motor Drive 1, and (as a power unit) the M. 18V Control Grip 1 or M. 15V Ni-Cd Control Pack 1.

\* Optimum conditions for sequence operation: Maximum framing rate varies with temperature, types of film and batteries, etc. The word optimum implies normal temperature, shutter speeds of 1/500 second or faster, and using the M. 18V Control Grip 1 containing fresh alkaline batteries. Cartridges with smooth film movement must be used.

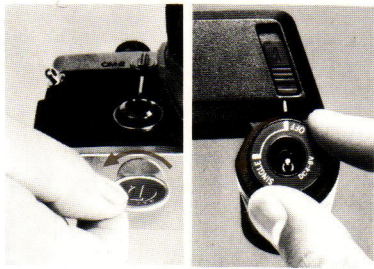

■ Attaching the Winder 1

① Remove the motor drive socket cap. Remove the motor drive socket cap from the camera base plate by rotating it counter-clockwise with a coin until the index dot on the cap is aligned with the index dot on the camera.

To replace the cap, align the index dot on the cap with the index dot on the camera, and turn the cap clockwise with a coin until the index dot on the camera is aligned with the groove on the cap.

(The removed motor drive cap can be stored in the socket cap storage positioned on the underside of the battery holder compartment.)

② Pull up and rotate the switch dial to the "OFF" position.



③ Attach the Winder 1.

① Remove the M.6V Battery Holder 1 from inside the winder, insert four 1.5 V penlight (AA) size batteries into the battery holder, and put it back into the compartment.

② Insert the motor drive guide pin into the guide pin hole on the camera base plate. To assure proper connection, adjust the position of the Winder 1 until it is flush with the camera. Turn the clamping screw clockwise until the Winder 1 is securely attached to the camera base plate.

The Winder 1, designed primarily for single-frame shooting, operates on four self-contained AA batteries and is extremely compact and light. The unit advances the film and cocks the

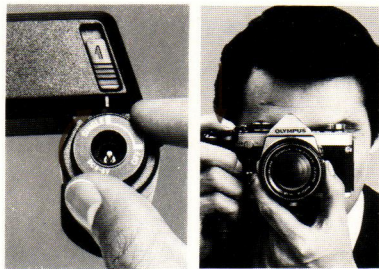

■ Taking the pictures

- ① Pull up and rotate the switch dial to the "SINGLE" position.
- ② Press the shutter release.

shutter as soon as exposure is made (operational time —0.3 sec.), so that the photographer can always be ready to freeze the subject at the right moments.



■ Motor Drive 1/M.18V Control Grip 1/M.15V Ni-Cd Control Pack 1



# OLYMPUS OM-2 OPERATION OF BASIC MOTOR DRIVE PACKAGE

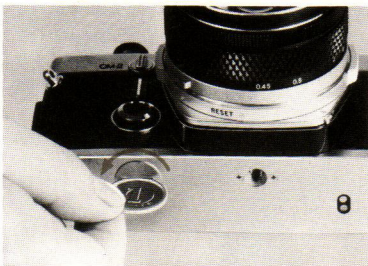

## ■ Attaching the Motor Drive 1

- 1 Remove the motor drive socket cap. (See page 28, left column.)



- 2 Attach the Motor Drive 1 in the same manner as with the Winder 1. (See page 28, middle column.)

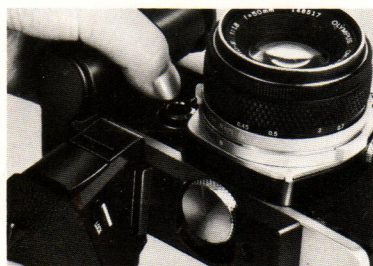

## ■ Attaching the M. 18V Control Grip

- 1 Remove the M. 18V Battery Holder 1, insert twelve 1.5V penlight (AA) size batteries into the battery holder, and re-insert the battery holder into the control grip.
- 2 Align the red index line on the rear of the control grip with the red index line on the rear frame of the motor drive unit until the mounting catch is engaged.
- 3 Carefully push the control grip forward until it snaps into the front of the motor drive.

## ■ IMPORTANT:

\* Always store the socket cap in the same place to avoid loss.

\* After removing the motor drive from the camera, be sure to replace the socket cap to keep the camera free of dust and

dirt, and to prevent the possibility of stray light entering the socket and fogging the film.

\* Do not remove the socket cap when you do not use the motor drive.

\* Voltage Requirement: DC 18V with "AA" size batteries, or DC 12V–16V with external power sources of large potentiality in conjunction with relay cords.

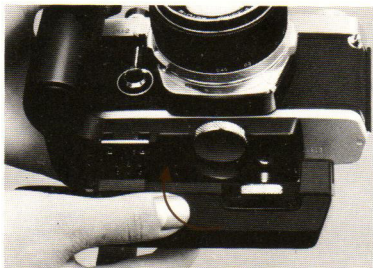

#### ■ Attaching the M. 15V Ni-Cd Control Pack 1

Prior to use, the Control Pack should be checked to insure that it has been adequately charged. If its charge is inadequate, use the M. 15V Ni-Cd Charger.

Aligning the red index lines of the Motor Drive 1 and the Control Pack, engage the mount catch. Then push the Control Pack forward and upward until it snaps on the motor drive, then clamp securely.

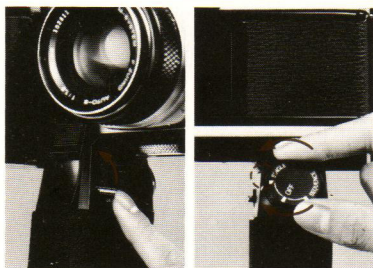

#### ■ Photography with the Motor Drive Units

##### Using the M. 18V Control Grip 1

① Unlock the shutter release lock lever on the Control Grip by moving it forward and upward.

\* This is provided to lock the shutter release on the Control Grip for safety sake in general or for the use of a relay cord.

② Turn the mode selector on the Control Grip to either "SINGLE" or "SEQUENCE". In either mode, automatic exposure control is possible in the full range of shutter speeds and manual exposure is possible from 1 second to 1/1000 second.

Set the mode selector to the "OFF" position when the Motor Drive 1 is not in use.



③ You may use either the shutter release on the Control Grip 1 or the shutter release on the Motor Drive 1 to trigger the shutter. It is generally more convenient to use the shutter release on the Control Grip when the camera is held in the horizontal position and the shutter release on the Motor Drive 1 when the camera is held in the vertical position.



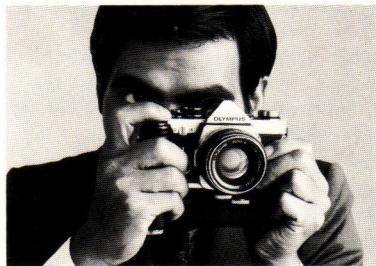
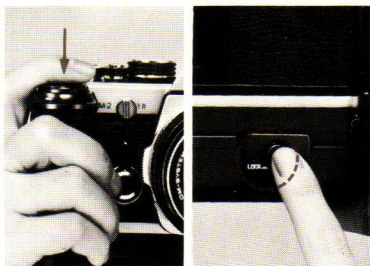
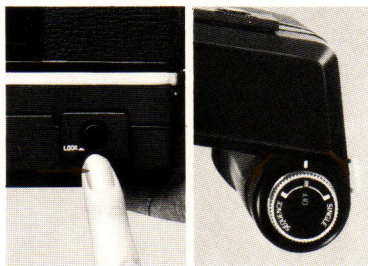

### Using the M. 15V Ni-Cd Control Pack 1

① Slide the shutter release lock button on the Control Pack 1 to the unlock position.

\* This device is provided to lock the release button on the Control Pack for unintentional shutter release in general or when a relay cord is used, etc.

② Pull and turn the mode selector until it clicks to either "SINGLE" or "SEQUENCE".

In either mode, available shutter speeds are the same as with the Control Grip. (See page 31, ②.)

③ You may use either the shutter release on the Control Pack 1 or the shutter release on the Motor Drive 1 to trigger the shutter. It is generally convenient to use the shutter release on the Motor Drive 1, and the shutter release on the Control Pack 1 for the use of the 250 Film Back 1.

### ※ Loading the Film

Always load your camera with film *after* the Motor Drive has been attached. This eliminates any possibility of film fogging from the light that leak into the camera as the Motor Drive is attached. If this is not possible, attach the Motor Drive unit in a dimly-lit area.

At night, indoors, and in the many cases when the intensity or quality of ambient light renders it unsuitable for a given photographic purpose, electronic flash or bulbs provide a source of easily controlled, high intensity light. Your choice of a flash unit will depend upon your individual photographic needs, and may include the Olympus Quick Auto 310 (for TTL Centralized Control Flash, normal autoflash and manual flash), PS 200 Quick or PS 200 (for manual flash).

The Accessory Shoe 2 is used to connect the Quick Auto 310 with the OM-2 to perform the TTL Centralized Control Flash operation. For connecting a conventional electronic flash or flash-bulb with the OM-2, either the Accessory Shoe 2 or 1 may be used.

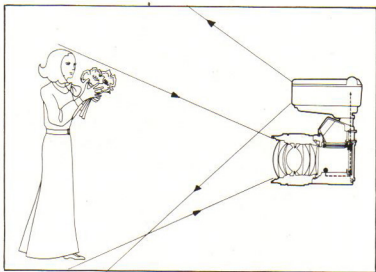

#### ■ TTL Centralized Control Flash

In TTL Centralized Control Flash, the light sensors and electronic brain built into the OM-2 automatically control the light emission level of the Quick Auto 310. The system increases the versatility and convenience of flash photography by permitting the selection of any lens aperture, eliminating the need for film speed and aperture setting on the flash unit, reducing the minimum working distance, and allowing use in conjunction with the Auto Bellows. It also increases exposure accuracy by measuring the flash emission level precisely over the field covered by the lens in use. Fully automatic TTL bounce flash is readily available by using the Quick Auto 310 with the Bounce Grip and Auto Cord 0.6m.

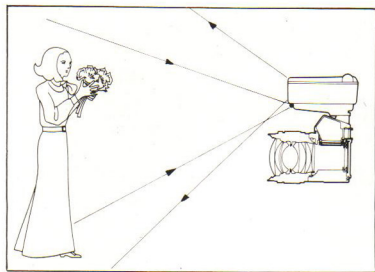

#### ■ Normal Auto Flash

In ordinary automatic flash using a conventional automatic electronic flash unit (or the Quick Auto 310 set to Normal Auto), the photographer sets the lens and flash unit to one of the F stops available. The flash is measured by the light sensor built into the flash unit and automatically cut off when the correct exposure has been made.

#### ■ Manual Flash

To obtain correct exposure, an appropriate F stop should be determined by using the calculator dial or exposure table of the flash unit, or the guide number formula (page 37).

Camera		Setting of OM-2/Lens				
Flash Unit	Flashing Method	Flash Holder	Synchro Contact	Selector Lever	Shutter Speed	F Stop
Quick Auto 310	TTL Centralized Control Flash	Accessory Shoe 2	X	AUTO	$\frac{1}{30}$ sec.	All F stops available by lens
	Normal Auto Flash	Accessory Shoe 2 or Accessory Shoe 1	X	MANUAL	$\frac{1}{30}$ sec. ※	3 F stops (F4, F5.6 or F8 at ASA100)
	Manual Flash	Accessory Shoe 2 or Accessory Shoe 1	X	MANUAL	$\frac{1}{30}$ sec. ※	Determined by guide number formula, calculator dial or exposure table (HI-GN 34, LOW-GN 17)
Ordinary Automatic Electronic Flash Unit	TTL Centralized Control Flash	—	—	—	—	—
	Normal Auto Flash	Accessory Shoe 2 or Accessory Shoe 1	X	MANUAL	$\frac{1}{30}$ sec. ※	F stops designated by auto flash unit
	Manual Flash	Accessory Shoe 2 or Accessory Shoe 1	X	MANUAL	$\frac{1}{30}$ sec. ※	Determined by guide number formula, calculator dial or exposure table
Olympus PS200 or Manual Electronic Flash Unit	TTL Centralized Control Flash	—	—	—	—	—
	Normal Auto Flash	—	—	—	—	—
	Manual Flash	Accessory Shoe 2 or Accessory Shoe 1	X	MANUAL	$\frac{1}{30}$ sec. ※	Determined by guide number formula, calculator dial or exposure table

※ The OM-2 synchronizes with the electronic flash at  $\frac{1}{30}$  sec. or slower. However, to ensure fail-safe flash exposures, it is recommended to set the shutter speed to  $\frac{1}{30}$  sec.



# OLYMPUS OM-2 OPERATION OF QUICK AUTO 310

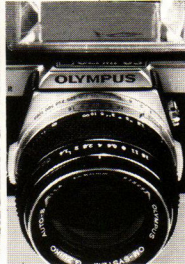
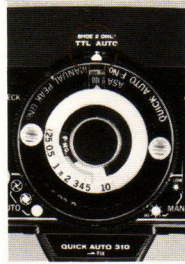
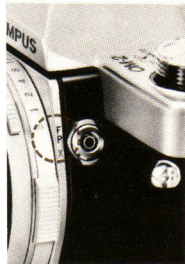

## ■ TTL Centralized Control Flash

- 1 Attach the Accessory Shoe 2 to the OM-2.
- 2 Mount the Quick Auto 310 on the Accessory Shoe 2.

- 3 Set the camera's synchro terminal (FP and X flash selector) to "X".
- 4 Set the camera's selector lever to "AUTO".

- 5 Set the flash unit's switch dial to "TTL AUTO".
- 6 Set the F stop of your choice with the camera's aperture ring. Any F stop can be selected as long as it is within the TTL Auto working range (indicated in the distance scale window).

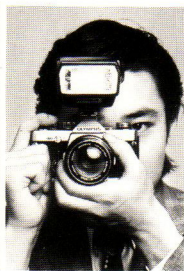
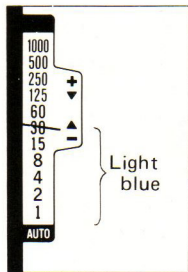

**7** Check the shutter speed.

Focus on your subject and make sure the meter needle points 1/30 second or slower (the speed range indicated in light blue in the viewfinder). If the shutter speed is out of this range, remedy by turning the aperture ring to a larger F-number (smaller aperture).

**8** Press the shutter release button. When correct exposure is made, the auto check lamp flickers. When the lamp failed to flicker, the amount of flash light was insufficient: to remedy, move to the subject or select a smaller F-number (larger aperture).

\* The OM-2 incorporates an incorrect flash prevention system. If the shutter speed is faster than 1/60 second, the electronic flash will not fire when you press the shutter release button.

**■ Normal Auto Flash**

The Quick Auto 310/OM-2/Accessory Shoe 2 combination offers the fastest kind of flash operation with excellent results. In the following cases, however, Normal Auto method must be conducted: 1) On-camera flash linked with Accessory Shoe 1, 2) Off-camera flash linked with Bounce Grip via synchro cord (in case Auto Cord 0.6m is not available).

- 1** Attach the Accessory Shoe to the OM-2.
- 2** Mount the Quick Auto 310.
- 3** Set the synchro terminal to "X".
- 4** Set the selector lever to "MANU-AL".
- 5** Set the ASA film speed on the flash unit.
- 6** Set the shutter speed ring to a shutter speed of 1/60 second or slower (1/30 sec. recommendable).
- 7** Set proper F stop on the flash unit. (F4, F5.6 or F8 depending on your desired effects.)
- 8** Set the camera's aperture ring to the F stop set on the flash unit.
- 9** Press the shutter release button.

When correct exposure is made, the auto check lamp flickers. Before-shooting check is also possible by using the test button.

**■ Manual Flash**

To produce various effects you desire, the manual method is highly useful, particularly for daylight fill-in.

- 1** Attach the Accessory Shoe to the OM-2.
- 2** Mount the Quick Auto 310.
- 3** Set the synchro terminal to "X".
- 4** Set the selector lever to "MANU-AL".
- 5** Set the ASA film speed on the flash unit.
- 6** Set the shutter speed ring to 1/60 second or slower (1/30 sec. recommendable).
- 7** Set the switch dial to HI (full power, GN 34 at ASA 100 in meters, at peak) or to LOW (1/4 power, GN 17) depending on your desired effects.
- 8** Set the camera's aperture ring. Set the aperture ring to the F stop that corresponds with the planned flash-to-subject distance shown in the distance scale.
- 9** Press the shutter release button. (For detailed daylight fill-in flash, refer page 37, right column, and 38.)

## OLYMPUS OM-2 OPERATION OF FLASH UNITS OTHER THAN QUICK AUTO 310



### ■ Operation of ordinary Automatic Electronic Flash Units

- 1 Attach the Accessory Shoe 1 or 2 to the OM-2.
- 2 Mount the flash unit on the camera.  
\* If your electronic flash unit does not have a direct contact "hot shoe", connect its synchro cord to the flash synchro socket on the camera.
- 3 Set the camera's synchro terminal switch to "X".
- 4 Set the camera's selector lever to "MANUAL".
- 5 Set the ASA film speed on the flash unit.



6 Set the shutter speed ring to a shutter speed of 1/60 second or slower (1/30 sec. recommendable).

7 Set the F stop on the aperture ring.

1 Auto Flash Exposure Control  
Follow your flash equipment instructions for the selection of F stop for automatic flash exposure control.

2 Manual Flash Exposure Control  
Determine the correct F stop for proper flash exposure by using the calculator dial or exposure table provided with your flash equipment. You may also determine the correct F stop by using the following formula:

$$F \text{ stop} = \frac{\text{flash guide number}}{\text{flash-to-subject distance}}$$

Set the camera's aperture ring to the F stop selected, and press the shutter release button.

### ■ DAYLIGHT FILL-IN FLASH

1 Manual Flash Exposure Control

1 If your electronic flash unit has manual/auto flash exposure control, set it for manual operation.

2 Focus on your subject to determine the camera-to-subject distance.

3 Using the calculator dial, exposure table, or guide number formula, determine the correct F stop for proper flash exposure at the distance you found in Step 2. Set this F stop with the camera aperture ring.

4 Set the camera's selector lever to the "MANUAL" position.

5 Turn the shutter speed ring until the meter needle centers between the over- and under-exposure index marks in the camera viewfinder.

6 If the shutter speed is 1/60 second or slower, you are ready to take the picture.

If the shutter speed is faster than 1/60 second, the flash will not fire if you attempt to take the picture. Therefore, you must readjust the exposure settings as follows:



- a. Reset the shutter speed to 1/60 second.
- b. Turn the aperture ring until the meter needle centers between the over- and under-exposure index marks in the camera viewfinder.

c. Using the flash calculator dial, exposure tables, or guide number formula, determine the correct flash-to-subject distance for the F stop now set on the camera's aperture ring.

d. Move to this distance from the subject and re-focus *or* remove the flash unit from the camera and move it only to this distance from the subject using a synchro cord extension to maintain flash synchronization with the camera.

## ② Automatic Flash Exposure Control

① If your electronic flash unit has manual/auto flash exposure control, set it for auto operation.

② Set the camera's selector lever to the "MANUAL" position.

③ Set the camera's shutter speed ring to 1/60 second.

④ Turn the aperture ring until the meter needle centers between the over- and under-exposure index marks in the camera's viewfinder.

⑤ Focus on your subject to determine the camera-to-subject distance.

⑥ If your electronic flash unit has an "AUTO F STOP" that corresponds with the F stop set on your camera and if that "AUTO F STOP" will provide automatic flash control within the distance range you found in Step 5, you may take the picture using this "AUTO F STOP" setting on your electronic flash unit. If these conditions are not met, use the procedures for Manual Flash Exposure Control.

## ■ FLASHBULB PHOTOGRAPHY

① Mount the Accessory Shoe to the camera and insert the shoe mount of the flash unit into the Accessory Shoe.

\* If your flash unit does not have a "hot shoe" contact, plug the flash unit's synchro cord into the synchronizing socket.

② Set the camera's selector lever to the "MANUAL" position.

③ Select the proper shutter speed and synchro setting from the table below according to the type of bulb being used and make these settings on the camera.

④ Determine the correct F stop for flash exposure by using the guide number formula. (See page 37.)

\* The guide number for any flashbulb/film combination may be found on the flashbulb packaging.

⑤ Set the correct F stop with the camera's aperture ring.

■ The table indicates proper synchronization speeds for most flash equipment.

Terminal	Flash Lamp	Shutter Speed										
		1000	500	250	125	60	30	15	8	4	2	1
F P	F P	○	○	○	○	○	*	*	*	*	*	*
X	Electronic Flash					○	○	○	○	○	○	○
	M F						*	○	○	○	○	○
	M · F P							○	○	○	○	○

○ = Recommended; \* = Not recommended due to bulb quality.



The self-timer provides a method of taking delayed action pictures allowing you to get into your own photographs. It is also ideal for macrophotography when a cable release is not available.

To set the self-timer:

1) Rotate the self-timer lever counter-clockwise until it stops (approximately  $180^\circ$ ). Make sure the film has been advanced properly.

2) Turn the start lever clockwise to the vertical position to activate the self-timer lever. The shutter will then be released in approximately 12 seconds. You can adjust the delay time between four and twelve seconds by adjusting the lever as shown above.

If the film has not been advanced properly, the timer lever will stop halfway and the shutter will not fire. To re-acti-



vate the timer, move the start lever counter-clockwise to stop the timer lever, return the timer lever to the starting position, and advance the film. Then, turn the start lever again.

**NOTE:** If you do not reset the self-timer, the timer lever will begin moving immediately after advancing the film and the shutter will be released earlier than expected.

You may set the self-timer lever either before or after advancing the film. Even after setting the lever, you can release the shutter by pressing the shutter release button. To stop the self-timer during its operation, turn the start lever counter-clockwise.

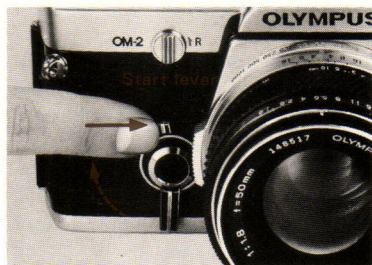

\* The OM-2 incorporates the Through-The-Lens Direct Light Measuring System, so that the automatic light measuring is protected from any influence of light coming from the viewfinder eyepiece even during the time delayed exposure, consequently making unnecessary the use of an eyepiece shutter.

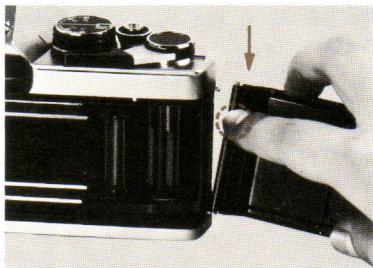

The camera back of the OM-2 is fully interchangeable with the Recordata Back 1 and 250 Film Back 1. To remove the camera back, push down on the release pin as shown. Do not remove the back unless necessary.

The Recordata Back 1 registers data such as date, number, alphabetical code, etc. directly on the picture.

The 250 Film Back 1 is designed for winder or motor drive shooting; it accepts a bulk loaded magazine of 250 frames.

1. When you do not use the camera for a long period of time, store it with the shutter uncocked and turn off the self-timer and exposure meter. Keep it free from dust and moisture, and remove it from the case.
2. When storing the camera for a long period of time, remove the batteries. Wipe all battery surfaces with a dry cotton cloth before re-inserting them into the camera.
3. Avoid dropping or hitting the camera.
4. Never store the camera where temperatures exceed 50°C (122°F). When you use the camera in temperatures under -20°C (-4°F), it may sometimes fail to operate properly. To avoid this, warm the camera before use. Protect against excess moisture by using silica gel or other desiccant.
5. After use near the ocean, wipe the camera surfaces clean with a soft cloth; never leave salt on the camera. (Salt may be airborne near the ocean and collect on the camera even though it has not been in direct contact with water.)
6. Avoid excessive force when mounting on a tripod.
7. Never expose the camera to direct sunlight. Avoid areas exposed to salt water, radios, TV sets, or magnets.
8. Have all repairs performed by an authorized OLYMPUS Service Center. You may send it directly or through the store where you bought your camera.
9. Avoid touching the surfaces of the lens. Clean only with an air brush, anti-static brush, or wipe it lightly with a camel hair brush or lens tissue. In EXTREME cases, use a clean, soft cotton cloth moistened with denatured alcohol. NEVER rub the lens surfaces with your finger, clothing, or other abrasive material.
10. If dust or fingerprints collect on the mirror, focusing screen, or prism, take the camera to an authorized OLYMPUS Service Center. It needs professional attention.
11. Do not press the release lever at random.
12. Do not touch any part that moves at high speed such as the shutter, instant return mirror, diaphragm, etc.



**Q: My camera is loaded with film. Why doesn't the rewind knob rotate when I advance the film?**

**A:** The film leader may not have caught securely on the film take-up spool. (See page 8.)

**Q: Why can't I advance the film?**

**A:** The shutter may be cocked and ready to fire. Try pressing the shutter release button. (See page 9.)

Or, the film may be fully exposed. Check the exposure counter. Or, the self-timer may be set. If the self-timer lever is not securely in its upright position, reset and release the self-timer. (See page 39.)

**Q: Why won't the shutter release button move when I press it?**

**A:** The film advance lever may not have been fully advanced. (See page 9.)

**Q: I can't advance the film nor release the shutter, and the viewfinder is totally dark. Why?**

**A:** The mirror is locked up because the batteries are depleted or the film was advanced in the middle of an automatic exposure. Turn the shutter speed ring to the "RESET" position (See page 7) to unlock the mirror and check the batteries (See page 7) replacing them if necessary.

**Q: Why won't the rewind crank turn when I try to rewind the film?**

**A:** The rewind release lever may not be set properly. Make sure the lever is rotated until the red dot is opposite the "OM-2" marking. (See page 11.)

**Q: Why can't I set the ASA film speed I need?**

**A:** In some cases, as few as 3 stops can be increased or decreased in a single stroke of the dial. If you require more stops, repeat adjusting the dial until you reach the ASA film speed you need. (See page 12.)

**Q: How can I align the white line on the exposure compensation dial with the black index line on the pentaprism after selecting the ASA film speed?**

**A:** Rotate the exposure compensation dial and the film speed scale together (don't lift up on the collar when turning).

**Q: What batteries should I use?**

**A:** Use two 1.5V silver oxide batteries (Eveready (or UCAR) S-76 or equivalent). Never use 1.3V mercury batteries (they are the same size). (See page 7.)

**Q: Why doesn't the battery chamber cap fit?**

**A:** If you also own an OM-1, you may have the caps mixed up. Although they look alike, the OM-1 and the OM-2 battery chamber caps are of a different size. The OM-2 cap has a "2" engraved inside.

**Q: When should I check the batteries?**

**A:** (1) When new batteries are inserted. (2) After the camera hasn't been used for a long time. (3) Whenever the mirror locks up. (4) Before a prolonged period of use.

**Q: Can film be properly exposed when the selector lever is in the "OFF" position?**

**A:** The OM-2 is designed to always expose the film loaded faster than approximately 1/30 second (ASA 100) with the selector lever at the OFF position. If darker, the exposure is insufficient.

**Q: Can I set the shutter speed ring to any position to take pictures with automatic exposure control?**

**A:** Any position except "B".

**Q: Why is the automatic exposure shutter speed much longer than indicated by the meter in the viewfinder?**

**A:** If film is not loaded, the shutter speed is much longer than that indicated. If it is necessary to obtain a correct reading without actually taking a picture, insert a waste, undeveloped film or the paper you find behind the camera back at the purchase of your OM-2, into the film position in the camera.

**Q: Can I use the exposure compensation dial when the selector lever is set at the "MANUAL" position?**

**A:** Yes. If the exposure compensation dial is set for an intentional over- or under-exposure, that over- or under-exposure will be achieved when the shutter speed/F stop combination centers the meter needle between the over- and under-exposure index marks in the viewfinder. (See page 19.)

**Q: Is it normal for the microprism in the center of the viewfinder to "shimmer" and darken?**

**A:** Yes. This is natural when a lens with a maximum aperture smaller than F5 is mounted on the camera. It also happens with other lenses when the depth of field preview button is pressed.

**Q: How can I remove dust from inside the viewfinder?**

**A:** After detaching the Focusing Screen, blow away any dust with an air blower. (See page 26.) If this does not solve the problem, send your camera to an authorized OLYMPUS Service Center.

**Q: Why does the self-timer stop halfway without releasing the shutter?**

**A:** The lever will stop without releasing the shutter if the film has not been fully advanced. Reset the self-timer and make sure the film is fully advanced. The self-timer lever plays idly because you forget to turn the start lever after you have set the self-timer lever. (See page 39.)

**Q: Can I operate the camera without the motor drive socket cap in place?**

**A:** No. Light will enter the camera body through this hole, fogging the film. Also, dust and dirt may enter through this hole causing a camera malfunction. (See page 30.)

**Q: Why doesn't my electronic flash unit fire when I release the shutter?**

**A:** Check the batteries and circuit of your flash unit. Check the shutter speed setting and change to 1/60 second or slower if necessary. At manual operation, the built-in incorrect flash prevention system does not permit flashing at shutter speeds between 1/125 second and 1/1000 second.

**Q: Why do I feel a small electrical shock when I touch the terminal contact of the accessory shoe?**

**A:** This is normal when using a side-mounting type flash. When using flash that is not connected to the accessory shoe, remove or cover the shoe.



One of many advantages of the single lens reflex type of camera is the large variety of interchangeable lenses available. Zuiko lenses, included in the Zuiko Interchangeable Lens Group of the OM System with those under development, have always enjoyed a high reputation in photographic circles — new design technology has made possible a new series of

innovative, high performance lenses. These lenses have a host of special features including a new construction that compensates for close focus aberrations, increased aperture ratio in the wide angle lenses, and reduction in telephoto lens size and weight. The OM System adopts 49mm filters for most lenses from 21mm to 200mm. As part of the

OM System design, all the lenses now offer higher performance in small configurations. OLYMPUS has produced lenses for microscopes for many years and the new Zuiko lenses benefit from this scientific experience. See the "OM System Zuiko Interchangeable Lenses" instructions for further information.









TYPE	INTERCHANGEABLE LENSES		ANGLE OF VIEW	OPTICAL CONSTRUCTION ELEMENT-GROUP	DIA-PHRAGM	F-STOP RANGE	MIN. FOCUS (ft.)	MIN. PHOTOGRAPHIC RANGE
FISHEYE	ZUIKO AUTO-FISHEYE	8mm F2.8	180°(circle)	11-7	AUTO.	2.8-22	0.2 m (0.7)	
	ZUIKO AUTO-FISHEYE	16mm F3.5	180°	11-8	AUTO.	3.5-22	0.2 m (0.7)	
SUPER WIDE	※ L ZUIKO AUTO-W	18mm F3.5	100°	11-9	AUTO.	3.5-16	0.25m(0.8)⊙	28×19cm
	G ZUIKO AUTO-W	21mm F3.5	92°	7-7	AUTO.	3.5-16	0.2 m (0.7)	21×14cm
	J ZUIKO AUTO-W	24mm F2	84°	10-8	AUTO.	2-16	0.25m(0.8)⊙	23×15cm
	H ZUIKO AUTO-W	24mm F2.8	84°	8-7	AUTO.	2.8-16	0.25m(0.8)	23×15cm
WIDE	I ZUIKO AUTO-W	28mm F2	75°	9-8	AUTO.	2-16	0.3 m(1.0)⊙	27×18cm
	G ZUIKO AUTO-W	28mm F3.5	75°	7-7	AUTO.	3.5-16	0.3 m (1.0)	27×18cm
	H ZUIKO AUTO-W	35mm F2	63°	8-7	AUTO.	2-16	0.3 m (1.0)	21×14cm
	G ZUIKO AUTO-W	35mm F2.8	63°	7-6	AUTO.	2.8-16	0.3 m (1.0)	21×14cm
	※ ZUIKO SHIFT	35mm F2.8	63°	7-7	MANUAL	2.8-22	0.3 m (1.0)	21×14cm
STANDARD	G ZUIKO AUTO-S	55mm F1.2	43°	7-6	AUTO.	1.2-16	0.45m (1.5)	23×15cm
	G ZUIKO AUTO-S	50mm F1.4	47°	7-6	AUTO.	1.4-16	0.45m (1.5)	24×16cm
	F ZUIKO AUTO-S	50mm F1.8	47°	6-5	AUTO.	1.8-16	0.45m (1.5)	24×16cm
	ZUIKO AUTO-MACRO	50mm F3.5	47°	5-4	AUTO.	3.5-22	0.23m(0.8)⊙	72×48mm
ZOOM	ZUIKO-AUTO-ZOOM	75-150mm F4	32°-16°	15-11	AUTO.	4-22	1.6 m (5.2)	64×42cm 32×21cm
TELEPHOTO	F ZUIKO AUTO-T	85mm F2	29°	6-4	AUTO.	2-16	0.85m(2.8)⊙	25×17cm
	E ZUIKO AUTO-T	100mm F2.8	24°	5-5	AUTO.	2.8-22	1 m (3.3)	29×19cm
	E ZUIKO AUTO-T	135mm F2.8	18°	5-5	AUTO.	2.8-22	1.5 m (4.9)	32×21cm
	E ZUIKO AUTO-T	135mm F3.5	18°	5-4	AUTO.	3.5-22	1.5 m (4.9)	32×21cm
	E ZUIKO AUTO-T	200mm F4	12°	5-4	AUTO.	4-32	2.5 m (8.2)	36×24cm
	F ZUIKO AUTO-T	200mm F5	12°	6-5	AUTO.	5-32	2.5 m (8.2)	36×24cm
SUPER TELEPHOTO	F ZUIKO AUTO-T	300mm F4.5	8°	6-4	AUTO.	4.5-32	3.5 m(11.5)	33×22cm
	E ZUIKO AUTO-T	400mm F6.3	6°	5-5	AUTO.	6.3-32	5 m(16.4)	36×24cm
	F ZUIKO AUTO-T	600mm F6.5	4°	6-4	AUTO.	6.5-32	11 m(36.1)	55×37cm
	E ZUIKO AUTO-T	1000mm F11	2.5°	5-5	AUTO.	11-45	30 m(98.4)	98×65cm
SPECIAL USE	ZUIKO MACRO	20mm F3.5	9° at highest mag.	4-3	MANUAL	3.5-16		max. 8 × 5mm min. 3 × 2mm
	ZUIKO MACRO	38mm F3.5	9° at highest mag.	5-4	MANUAL	3.5-16		max. 20 × 13mm min. 6 × 4mm
	ZUIKO 1:1 MACRO	80mm F4	9° at highest mag.	6-4	MANUAL	4-22		max. 72 × 48mm min. 18 × 12mm

Compatible: The meter needle indicates proper exposures. In the combination marked with \*, micropism, split-prism and edges of the finder darken.

Compatible: The meter on MANUAL can not be used. On AUTO, correct exposures are made, but the meter needle does not indicate correct shutter speeds.

WEIGHT (oz.)	LENGTH	MAX. DIAMETER	HOOD	FILTER	1-1	1-2	1-3	1-4	1-5	1-6	1-7	1-8	1-9	1-11	1-12	1-13				
					Micro matte type	Micro matte type	Split matte type	All matte type	Micro clear field type	Micro clear field type	Micro clear field type	All matte type	Clear field type	Cross hairs matte type	Cross hairs matte type	Microprism Split image matte type				
690g (24.3)	82mm	102mm	—	Built-in		*														
180g (6.3)	31mm	59mm	—	Built-in		*														
220g (7.8)	42mm	62mm	49mm Screw-in	72mm		*						FOR TELEPHOTOGRAPHY & ASTROPHOTOGRAPHY	FOR ENDOSCOPIC PHOTOGRAPHY	FOR CLOSE-UP & MACROPHOTOGRAPHY	FOR MACROPHOTOGRAPHY & PHOTOMICROGRAPHY					
180g (6.3)	31mm	59mm	49mm Screw-in	49mm		*														
270g (9.5)	48mm	60mm	55mm Screw-in	55mm		*														
180g (6.3)	31mm	59mm	49mm Screw-in	49mm		*														
240g (8.5)	43mm	60mm	49mm Screw-in	49mm		*														
180g (6.3)	31mm	59mm	49mm Screw-in	49mm		*														
240g (8.5)	42mm	60mm	55mm Screw-in	55mm																
170g (6.0)	33mm	59mm	51mm Slide-on	49mm																
300g (10.6)	58mm	68mm	49mm Screw-in	49mm	*	*	*													*
310g (10.9)	47mm	65mm	57mm Slide-on	55mm																
230g (8.1)	36mm	60mm	51mm Slide-on	49mm																
170g (6.0)	31mm	59mm	51mm Slide-on	49mm																
200g (7.1)	40mm	60mm	—	49mm																
440g (15.5)	115mm	63mm	Built-in	49mm																
260g (9.5)	46mm	60mm	49mm Screw-in	49mm																
230g (8.1)	48mm	60mm	49mm Screw-in	49mm																
360g (12.7)	80mm	61mm	Built-in	55mm																
290g (10.2)	73mm	60mm	Built-in	49mm																
510g (18.0)	127mm	67mm	Built-in	55mm																
370g (13.1)	105mm	62mm	Built-in	49mm																
1100g (38.8)	181mm	80mm	Built-in	72mm																
1300g (46.0)	255mm	80mm	Built-in	72mm	*		*									*				
2800g (98.8)	377mm	110mm	Built-in	100mm	*		*									*				
4000g (141.0)	662mm	110mm	Built-in	100mm	*	*	*									*				
70g (2.5)	20mm	32mm	—	21mm Slide-on	*	*	*	*								*				
90g (3.2)	28mm	43mm	—	32mm Slide-on	*	*	*									*				
200g (7.1)	46mm	59mm	—	49mm	*	*	*									*				



## ■ Filters

In general on many specialized photographic fields, filters are essential to the effective rendition of photographic subjects. Whether in black and white or color, filters are necessary additions to most camera systems. In controlling contrast and eliminating unwanted haze in black and white photography, the use of the correct filter often means the difference between a good photograph and a great one. In color, where the

balancing of the light with the film emulsion is absolutely necessary for correct color, conversion and light balancing filters are the only effective way of achieving the desired results.

\* Be careful not to use two filters simultaneously in order to avoid unintentional cut in the periphery of a photograph.

## ■ Lens Hoods

Lens hoods protect against extraneous

light striking the lens and causing unwanted glare. Hoods for standard lenses are cover types and can be reversed to provide easy storage even when the camera is in the case.

## ■ Camera Body Cap

## ■ Rear Lens Cap

## ■ Front Lens Caps

(49mm, 55mm, 72mm and 100mm in diameter)

OM System filters are ideal for use with OM System lenses. The use of two filters or other brand may cause vignetting.

Application	Name	Color	Description	Diameter			
				49mm	55mm	72mm	100mm
B. & W. and Color	Skylight (1A)	Colorless	Similar to UV filter. Eliminates ultraviolet rays. Reduces haze and bluish tones in daylight photography. Effective with color film only. May be used at all times to protect the lens.	○	○	○	○
	L39 (UV)	Colorless	Eliminates undesirable ultraviolet rays which cause dull, flat pictures. Renders subject in clear, detailed brilliance. May be used at all times to protect the lens.	○	○	○	○
	ND2 ND4	Grey Grey	Reduces the quantity of light entering the lens to 1/2 or 1/4 of the original intensity. For use in extremely bright conditions when you wish to maintain a wide aperture.	○	○	—	—
	Polarizing filter POL	—	Enables you to take pictures through glass or water without reflections. Will darken the sky in black-and-white photographs without altering other color values in the picture, and renders blue skies darker when used with color film. Reflections are reduced to provide better texture surface detail.	○	○	—	—
B. & W.	Y48 (Y2)	Yellow	Accentuates contrast, darkens blue skies. Very effective in daylight scenes where the sky is part of subject matter. Heightens the effect of white clouds. Useful in copying documents where line copy is blue or black on light background.	○	○	○	○
	O56 (O2)	Orange	Absorbs a wider range of wavelengths from UV to dark green than the Y2. Makes a superb rendition of the texture of outdoors subjects, and indoors. It brings out detail in objects yellow, brown. Used with infrared film.	○	○	○	○
	R60 (R1)	Red	Used as contrast filter to create darkened sky or in copying. Also used to penetrate haze in landscape photography for stronger contrast than an O2 filter. Used with infrared film.	○	○	○	○
Color	A4 (B1C)	Amber	For use when taking color pictures in cloudy or rainy weather. Reduces bluish tone.	○	○	—	—
	B4 (B2C)	Blue	Designed for use when taking color pictures in early morning or late evening hours when red rays are predominant.	○	○	—	—

## OM SYSTEM MOTOR DRIVE GROUP

Designed specifically to complement the OM Body, the Motor Drive Group, starting with the single-release Winder 1, has been reduced in size to enhance its maneuverability and ease of operation. Both the handgrip type motor drive and the control grip provide a built-in shutter release button so that the photographer can even hand-hold a 300mm telephoto lens for shooting sports or other action subjects. A 250 exposure roll film back and other units attach to the OM-2 without cords. This Motor Drive Group is also a convenient accessory when used with other groups for macrophotography, photomicrography, etc. The Motor Drive Group consists of a number of units for single and sequential exposures in all types of photography. A remote control mechanism is also available for a series of exposures taken intermittently in conjunction with the M. AC Control Box, or a series of exposures with bulk films. When mounted to the OM-2, the Motor Drive automatically adjusts for even the slightest changes of subject brightness for each frame even at the maximum filming rate by the use of the automatic exposure control built in the camera.

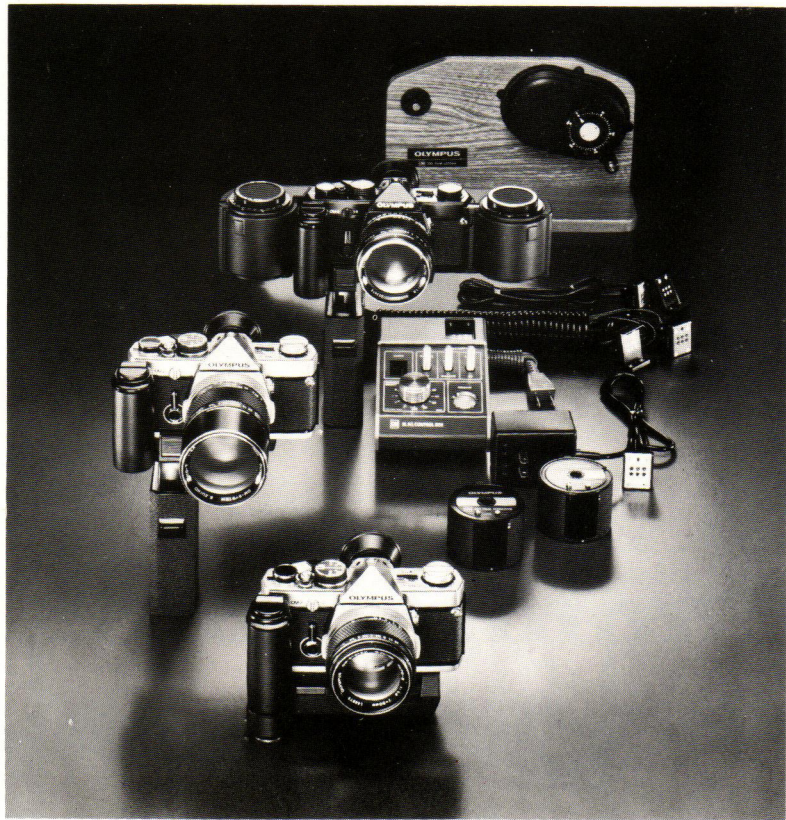







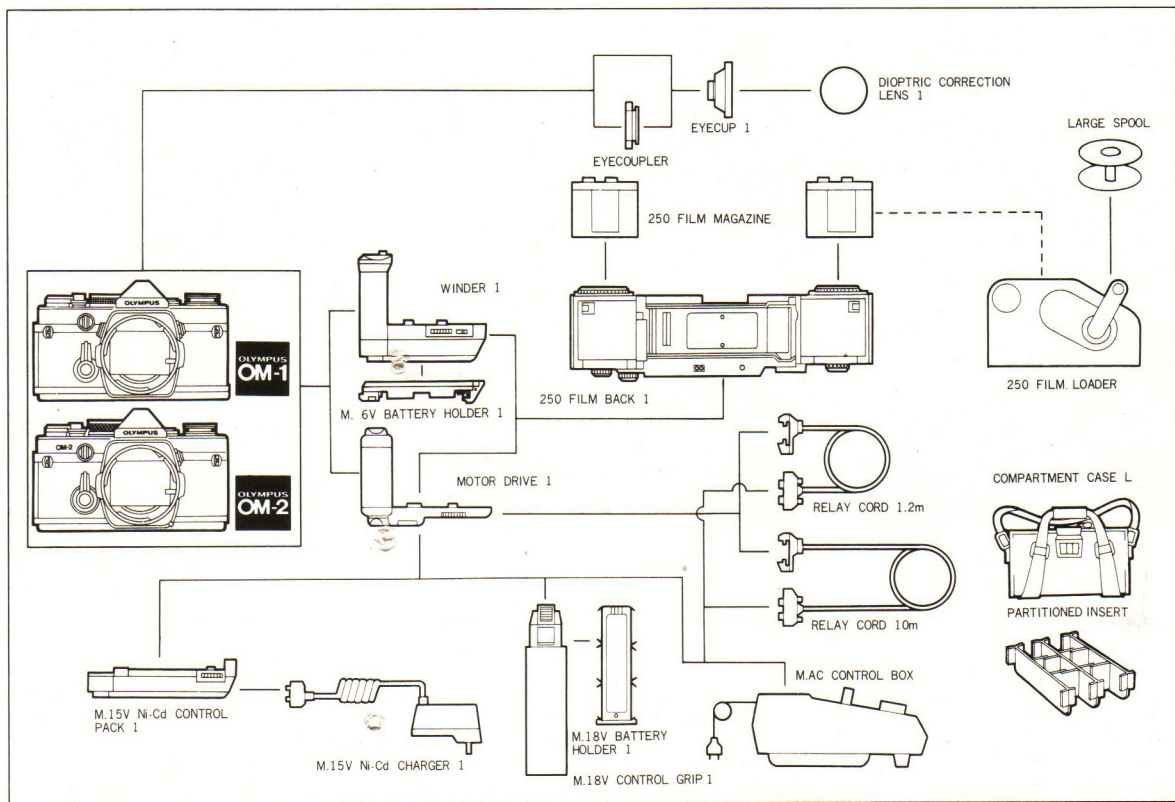

### ■ Winder 1 (with M. 6V Battery Holder 1)

Fixed directly to the camera base tripod socket, the Winder 1 functions integrally with the OM camera body to perform single frame shooting.

The unit winds the film in approx. 0.3 sec. as soon as the exposure is made, whenever the shutter release is pressed.



Operating on self-contained 4 AA Alkaline batteries, it is capable of powering approx. 50 rolls of 36-exposure film. Size: 130 × 64 × 100mm (5.12 × 2.52 × 3.94 in.) Weight: 290g (10.2 oz.) (less batteries)

### ■ Motor Drive 1

The basic motor drive unit that forms the foundation of the group. Fixed directly to the camera base tripod socket together with the power supply, it functions integrally with the OM camera body. Operating on various power sources such as penlight batteries, Ni-Cd batteries, or AC, it is capable of sin-



gle frame shooting and sequential filming of 5 frames per second.

Size: 116 × 82 × 66mm (4.57 × 3.23 × 2.59 in.) Weight: 210g (7.4 oz.)

### ■ M. 18V Control Grip 1 (with M. 18V Battery Holder 1)

A power supply that accepts 12 AA Alkaline or Ni-Cd batteries. Can be attached quickly to the Motor Drive 1. Complete with a built-in release button, single and sequence selector switch and release lock lever.

Size: 136 × 87 × 32mm, Weight: 160g (less batteries)

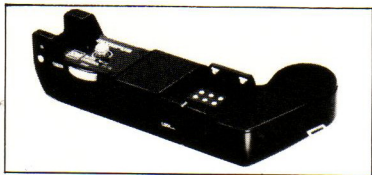

### ■ M. 15V Ni-Cd Control Pack 1

This is a flat-type rechargeable power unit equipped with a special built-in Ni-Cd battery to power the Motor Drive 1, and provides maximum continuous filming rate of 5 f.p.s. as well as the single release capability.

Size: 129 × 35 × 67mm, Weight: 260g

### ■ M.AC Control Box

AC transformer for use with household current. Incorporates a selector switch between single-frame operation and sequential exposure operation, a terminal for the relay cord and a timer for exposures in intervals from 4 frames per second to one frame every 120 sec.

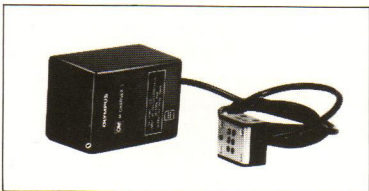

### ■ M.15V Ni-Cd Charger 1

This unit is necessary to charge the M.15V Ni-Cd Control Pack 1. By charging for about 4 to 5 hours, the Control Pack is capable of powering sequential filming of 40 rolls of 36 exposures films.

### ■ 250 Film Back 1, 250 Film Magazines

Can be quickly attached to the OM Body in place of the standard camera back, and used with the Motor Drive 1 or Winder 1 for roll films up to 250 exposures (10m or 32.8ft long). Two Magazines are necessary, one magazine holds the bulk film and a second magazine is used as a film take-up.

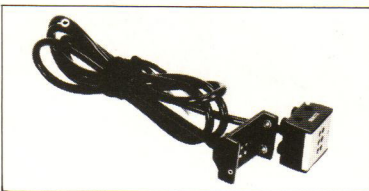
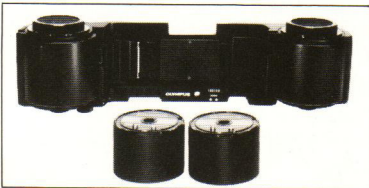

### ■ Relay Cords 1.2m and 10m

Extension cords for remote control; one is 1.2m (3.9ft), the other is 10m (32.8ft).

### ■ 250 Film Loader

This unit is used in the darkroom for loading the 250 Film Magazine from 33m (100ft.) bulk film rolls. A built-in mechanism automatically stops loading at preset film lengths.

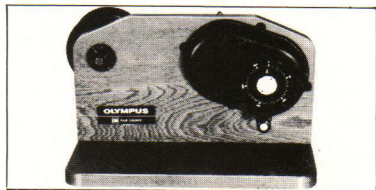

### ■ Compartment Case L ■ Partitioned Insert

The Compartment Case L is a hard dual-purpose shoulder or hand-carried case with two adjustable partitions. Capable of holding the Motor Drive set by use of the optional partitioned insert. (p. 80)



The viewfinder is one of the most important features of a single lens reflex camera. Since every photographic subject is turned into a visual image by means of the finder, a finder that is dark or difficult to look through is an obstacle to good photography. However enriched the SLR camera is with a wide range of interchangeable lenses, this SLR cannot be expected to fulfill its essential function without the provision for changing of focusing screens. The OM-2 is provided not only with an electronic shutter, but also with a viewfinder that offers a far brighter, larger image than conventional 35mm SLR cameras. The Finder Group supplements this basic advantage with a comprehensive set of 12 Focusing Screens for a wide variety of applications from photomicrography to astrophotography. Unless the most suitable focusing screen for a given photographic purpose is available, the potentialities of a system camera cannot be utilized. For fast, accurate focusing, the OM System Finder Group offers the unique Varimagni Finder with a magnification selector, the Eyecup 1 that accepts a variety of Dioptic Correction Lenses, Eyecoupler, etc.

## ■ Varimagni Finder

This unique and exclusive unit for the OM System combines the two functions of angle finder and magnifier, incorporating 9 lens elements and a reflector. It fits over the camera's eyepiece, and can be adjusted for individual eyesight. Its eyepiece tube is rotatable through  $360^\circ$ ,



for use in low level and  $90^\circ$  angled shots. The two-stage, one-touch switching system offers both a 1.2x magnification image covering the whole screen, and a 2.5x enlargement of the central portion for critical focusing. For photomicrographic use, insert the Eyecoupler between the camera and Varimagni Finder.

## ■ Eyecup 1

Attached by sliding over the OM Body eyepiece. With its attached rubber hood it prevents stray light from entering through the eyepiece, an essential requirement in manual light measuring. The Eyecup 1 is provided with a slot for Dioptic Correction Lenses.

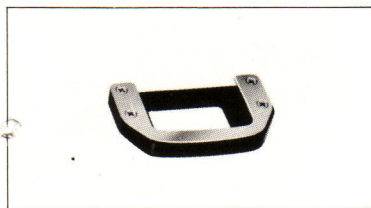

## ■ Eyecoupler

Connects the Varimagni Finder to the OM Body for photomicrography. It also ensures full coverage of the bright viewfinder field for use of the Eyecup 1 in conjunction with the Motor Drive 250 Film Back.

## ■ Focusing Screen 1

Interchangeable Focusing Screens are often thought of as a luxury feature in 35mm photography. Yet the Standard Focusing Screen 1-1 is often inconvenient or difficult to use, and in some circumstances it is quite unsatisfactory. With super-telephoto lenses for instance, the microprism becomes excessively dark. With the high magnifications of macro-photography and photomicrography, it is impossible to focus.

The feature of each Focusing Screen is listed at right. The 1-3 and 1-13, suitable for general photography, are particularly advantageous when taking a subject with vertical lines. The 1-5 is ideal for the snap-shooters using a wide angle lens. The 1-4 and 1-7 are designed for super-telephoto lenses and 1-4, 1-11 and 1-12 are for close-ups, macrophotography and photomicrography. The 1-5, 1-6, 1-7 and 1-9 are not used with the exposure meter built in the camera.



## ■ Dioptic Correction Lens 1

Available in 8 diopter corrections: +2, +1, 0 (for hypermetropia); -1, -2, -3, -4, -5 (for myopia). Used to correct the photographer's vision, and especially necessary in fine focusing for high magnification. Fits into the Eyecup 1.

TYPE	FEATURES	TYPE	FEATURES
<b>1-1 Microprism-matte type</b> (for most lenses)	Standard type, suitable for general photography. Fast and accurate focusing is done on the central microprism spot as well as on the surrounding matte area. When a lens with a maximum speed of F8 or slower is used, the microprism darkens and focusing must be made on the matte area. The meter needle indicates proper exposures.	<b>1-7 Microprism-clear field type</b> (for super telephoto lenses)	Developed primarily for use with super telephoto lenses, this clear field screen provides an extremely bright finder image. The microprism spot remains bright even with a lens whose maximum speed is F11. The lack of matte surface means depth-of-field effects cannot be ascertained, the meter needle does not indicate proper exposures.
<b>1-2 Microprism-matte type</b> (for standard & telephoto lenses)	Suitable for general photography in conjunction with a standard or telephoto lens. Focusing is done on the microprism spot as well as on the matte area. With a lens with maximum speed of F8 or slower is used, the microprism spot darkens. The meter needle indicates proper exposures.	<b>1-8 All matte type</b> (for telephoto lenses & astronomical telescopes)	This screen is ideal for use with super telephoto lenses of 300mm or more in focal length, or for astrophotography. The extreme fineness of the matte surface permits outstanding field definition. More accurate focusing may be achieved by the use of the Variamagni Finder.
<b>1-3 Split image-matte type</b> (for most lenses)	Suitable for general photography ensuring critical focusing, and ideal for photographers who prefer the split-field and coincidence type focusing. With a lens with a maximum speed of F5 or slower is used, the split prism darkens. The meter needle indicates proper exposures.	<b>1-9 Clear field type</b> (for endoscopic photography)	Designed for use with OLYMPUS fiberoptic endoscopes. This condenser type screen without fresnel lenses requires no focusing when a special adapter couples the camera with the fiberoptic. Exposure is made automatically by the light supply.
<b>1-4 All matte type</b> (for most lenses)	Suitable for general photography and ideal for photographers who prefer a view field free from microprism or split prism and for those who are accustomed to focus using matte area. Also suitable for super telephoto photography and close-up photography in conjunction with macro lenses and Auto Bellows. The meter needle indicates proper exposures.	<b>1-11 Cross hairs-matte type</b> (for close-up & macro-photography)	Highly advantageous for close-up and macrophotography with Auto Bellows and extension tubes. For focusing in low magnification close-up photography, use this matte area, and in macrophotography greater than life size, use the double cross hairs the same way as with the 1-12. The meter needle indicates proper exposures, but depending on the conditions of the specimen, the reading must be compensated for.
<b>1-5 Microprism-clear field type</b> (for wide angle & standard lenses)	This transparent screen provides an exceptionally bright finder image. Highly suitable for snapshots using wide angle lenses. The lack of matte surface, means depth-of-field effects cannot be ascertained. The meter needle does not indicate proper exposures, because its movement varies depending on the lenses used.	<b>1-12 Cross hairs-clear field type</b> (for photomicrography & macrophotography greater than life size)	The transparent screen offers the photographer focusing with an unusually bright finder image. To focus, first correct your diopter using a dioptic correction lens or Variamagni Finder so that each line of the double cross hairs can be seen clearly and separately. Then bring the specimen into focus. The meter needle indicates proper exposures, but depending on the specimen's conditions, the reading must be compensated for.
<b>1-6 Microprism-clear field type</b> (for standard & telephoto lenses)	This screen provides an extremely bright finder image. Focusing is done on the microprism spot. The lack of matte surface means depth-of-field effects can not be ascertained and the meter needle does not indicate proper exposures.	<b>1-13 Microprism/split image-matte type</b> (for most lenses)	Most suitable for normal photography, this screen assures pinpoint focusing. The central split-image rangefinder is encircled by a microprism collar. Since the outer area has a matte surface, the screen can be used in the same way as the standard 1-1 and 1-3 Screens. When a lens with a maximum speed of F5 or slower is used, the prism darkens and the focusing must be made on the matte area.



## OM SYSTEM FLASHPHOTO GROUP

Flash is your own private "sun" when you take pictures at night, indoors, or daylight fill-in. At the moment of flash, you can even catch the movement of subjects that your own eyes are unable to follow.

At present the OM System Flashphoto Group renders a choice of 3 different flash units, including the Quick Auto 310.

The Quick Auto 310 is the heart of the Group. Small and lightweight, it nevertheless offers high performance — a maximum ASA 100 (in meters) guide number 34 with an angle that virtually covers the picture area of a 24mm super wide-angle lens.

Beside the 3 automatic settings, 2 manual settings are also available in a single dial operation. During manual operation, flash intensity is freely controllable for fill-in lighting in daylight scenes, while the use of the Remote Sensor and Bounce Grip units allows automatic bounce flash.

Mounted onto the OM-2 via the Accessory Shoe 2, the Quick Auto 310 is regulated by the SBC light sensors and electronic brain built into the camera to automatically control the light emission level.









# OM SYSTEM CHART OF FLASHPHOTO GROUP

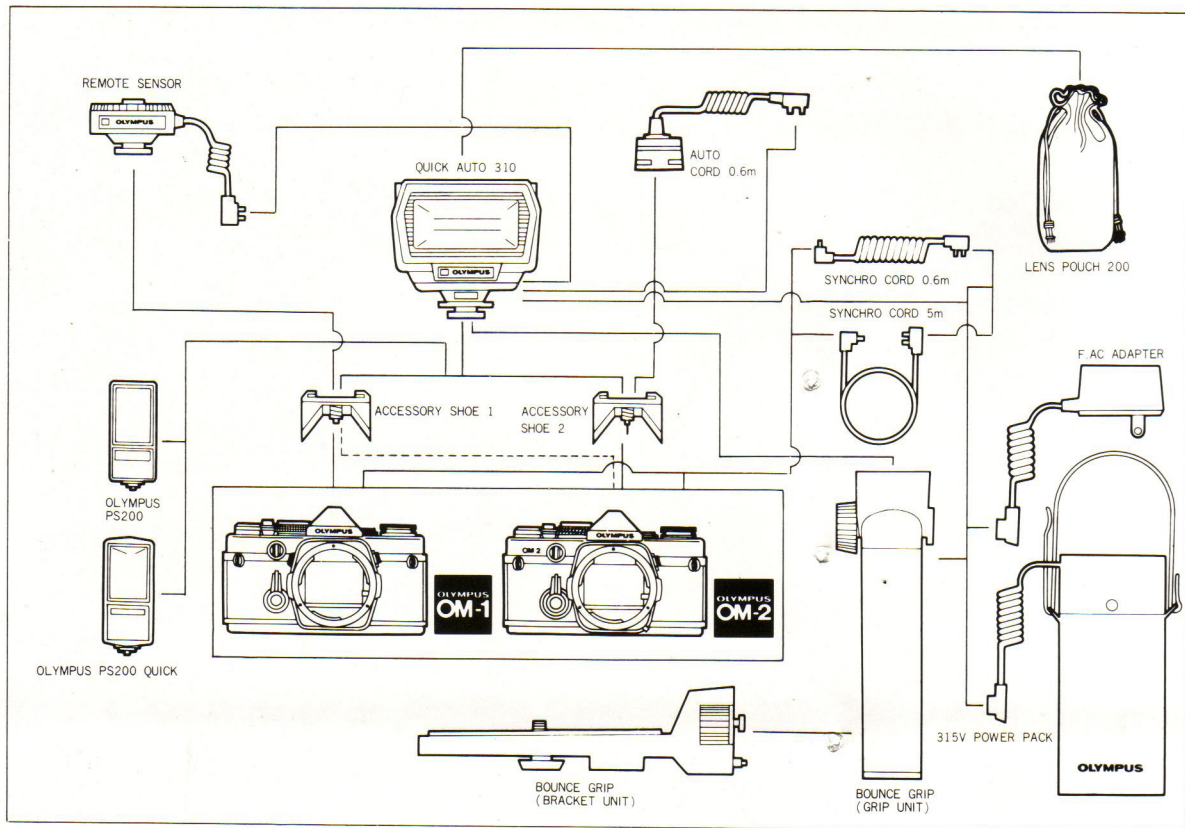

**■ Quick Auto 310**

With a guide number of 34 (ASA 100, meters), this is the most powerful flash unit generally available, offering a wide coverage to give enough illumination over the picture area of a 24mm super wide-angle lens without the aid of a wide adapter.

The Quick Auto 310 employs the world's first "TTL Centralized Control Flash" System: the SBC cells of the OM-2 TTL Direct Light Measuring system work also as a flash-light sensor. The System features: 1) the light acceptance angle accords with the picture angle of individual lens attached to the camera, 2) the ASA film speed and f/stop needn't be set on the electronic flash unit, 3) all f/stops of the lens can be used continuously, 4) the close-distance autoflash range is expanded, and 5) automatic bounce and diffuse flash, and extreme close-up with the Auto Bellows can be readily performed. With cameras other than the OM-2, the flash unit provides ordinary automatic flash capability at F4, F5.6 & F8. HI and LOW (1/4 power) manual settings are possible. Also incorporates an auto check lamp. Operates off 4 pen-light batteries with any direct contact camera. Can be used together with the Bounce Grip, permitting a choice of various power sources. (Nickel-

cadmium batteries cannot be used.)

**■ Bounce Grip**

This unit consists of the grip and bracket. The bracket can be connected to the grip instantly and slid to a desired position, capable of tilting through an angle of 90°. Four 1.5V C batteries are inserted into the grip to make it a higher-output power source. It also



allows automatic flash photography in bounce light in conjunction with the Remote Sensor. (Nickel-cadmium batteries cannot be used.)



### ■ Accessory Shoe 1, 2

The Accessory Shoe 1 is screwed into the hot shoe socket on the OM Body to provide direct contact with the clip-on type electronic flash. This unit also works as a holder for the Remote Sensor. The Accessory Shoe 2 is for use with the OM-2 and Quick Auto 310.

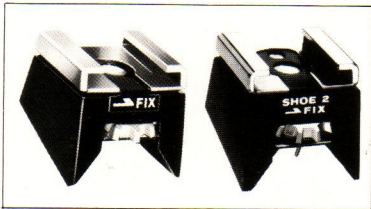

### ■ Remote Sensor

Designed for use with the OM-1, correct flash exposures can always be made no matter what bounce angle is, even when the Bounce Grip is detached from the OM-1, thus easily permitting auto bounce flash.



### ■ 315V Power Pack

A layer-built battery pack to be hung from the photographer's shoulder. The unit generates over 500 flashes at full power flash with short recycling time (approx. 1.5 sec.).

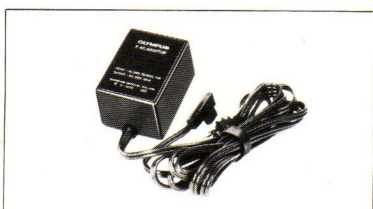
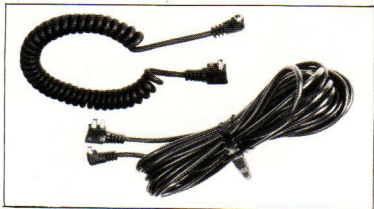

### ■ Synchro Cord 0.6m, 5m

Convenient to use the Quick Auto 310 for direct flash on a cold shoe, or with the Bounce Grip for off-camera flash. The Synchro Cord 5m is for greater off-camera distance than with the 0.6m.

### ■ Auto Cord 0.6m

Designed for use with the OM-2, Accessory Shoe 2 and Quick Auto 310 to perform off-camera TTL central control flash, TTL central control bounce flash (with Bounce Grip), etc.

### ■ F.AC Adapter

Plugged into an AC wall outlet, through which the AC household current supplies an almost unlimited number of flashes economically to the Quick Auto 310 and Bounce Grip.

### ■ Lens Pouch 200

Accommodates the Quick Auto 310.

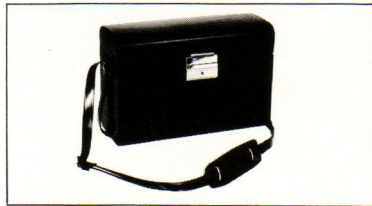
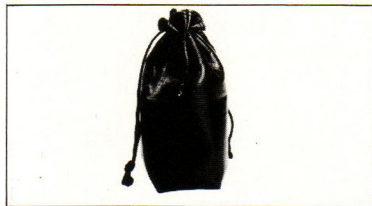

### ■ Compartment Case S

A hard shoulder case with two adjustable partitions, to accommodate the OM Body, Quick Auto 310, Bounce Grip, and Bracket.

### ■ OLYMPUS PS200

The PS200 operates on two 1.5V penlight batteries for use with all the current OLYMPUS cameras and any other cameras with hot shoe contact. Guide number 14 (in meters) or 45 (in feet) at ASA 80-100. Suitable to daylight type color films. Recycling time approxi-



mates 7 sec. and number of flash 200 times with fresh alkaline batteries. Measures 31 X 55 X 64mm (1.2" X 2.2" X 2.5"), weighing 75g (2.6 oz.) without batteries.

### ■ OLYMPUS PS200 Quick

The PS200 Quick is a compact electronic flash unit that operates on four 1.5V penlight batteries (alkaline or carbon/zinc) for use with the hot shoe cameras. This unit features a short recycling time from 2 sec. to 3 sec. Guide number 14 in meters (45 in feet), for



color and B&W films, ASA 80-100. Suitable to daylight type color films. Flash duration 1/1000 sec. Number of flash about 200 with alkaline batteries. Measures 32 X 73 X 71mm (1.3" X 2.9" X 2.8"), weighing 95g (3.4 oz.) without batteries.



## OM SYSTEM MACROPHOTOGRAPHY GROUP

Due to recent advances in macro-photography, it has become possible to pry out patterns and colors of unsuspected beauty in the minutiae of nature. A fast growing number of scientists and amateurs are taking the opportunity to explore the living world around them in a new depth.

The Macrophotography Group of the OM System provides them with all the tools necessary to capture this world of perfection on film, offering a complete range of convenient high performance accessories designed for specialists in the various fields of macrophotography. Starting from close-up photography with simple accessories such as Close-up Lenses, and Extension Tubes, you can extend your photographic techniques into the macrophoto world with the four Macro Lenses, Auto Bellows, Stands, Adapters, and a large variety of lighting equipment. This Group has no equal in its wide variety of accessories for macrophotography with a magnification range from 1/10x to about 10x. The automatic light measuring system built in the OM-2 with an emphasis on the lens aperture preference, heightens the value of the OM System in pursuit of perfection on film.









# CHART OF MACROPHOTOGRAPHY GROUP

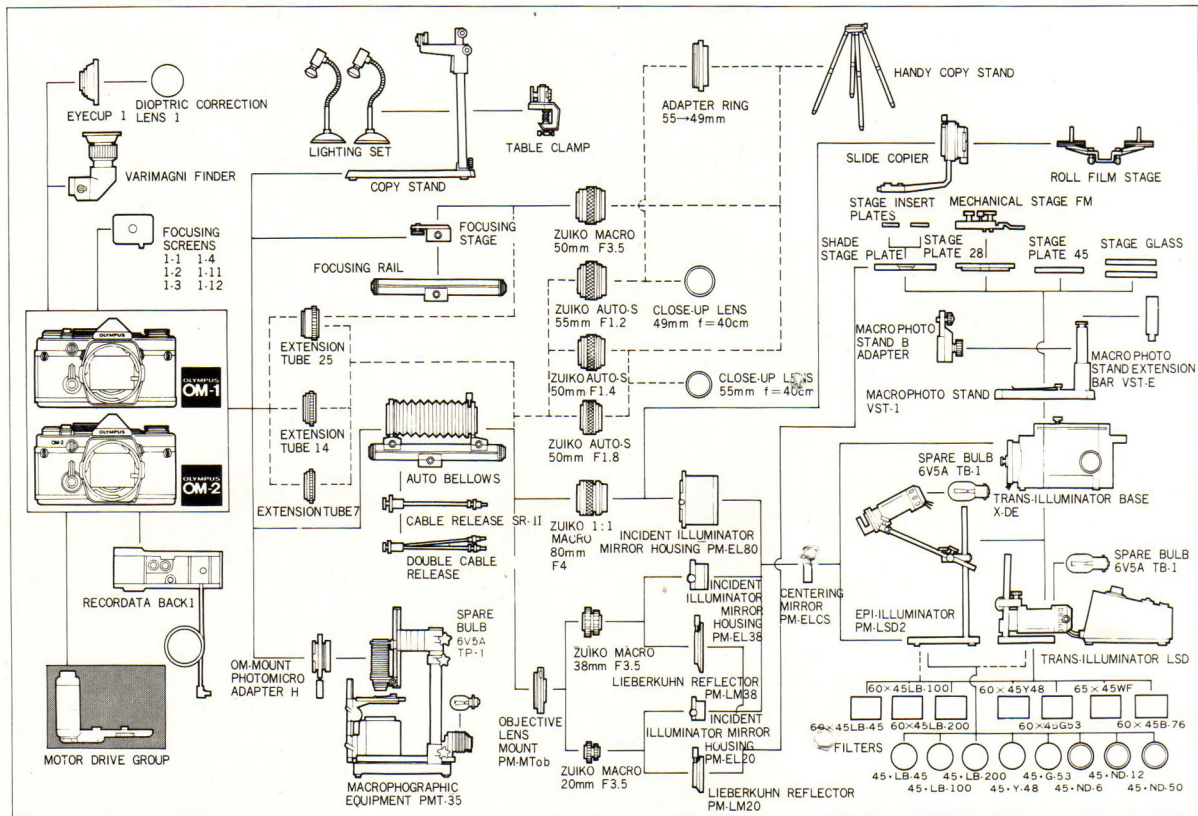

## ■ Close-up Lens 49mm f=40cm

## ■ Close-up Lens 55mm f=40cm

Available in both 49mm and 55mm diameters to fit all suitable OM System lenses. The use of them reduces the minimum focusing distance of a standard lens from 45cm (17.7") to 19cm (7.5") from the front lens surface.

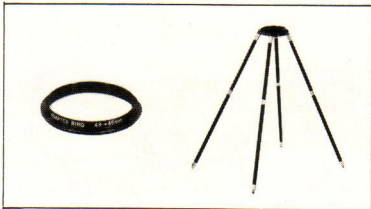
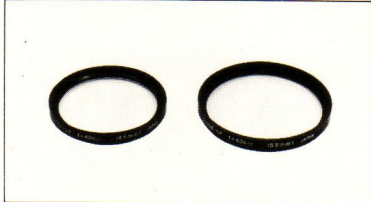

## ■ Handy Copy Stand

A four-legged stand for close-up and copy photography. The leg length is adjustable to three positions.

## ■ Adapter Ring 55 → 49mm

Connects the standard F1.2 to the Handy Copy Stand or the reversed 55mm dia. lenses to the Auto Bellows.

## ■ Extension Tubes 7, 14 and 25

Bayonet mount tubes fitting between the OM Body and the lens. They have extension of 7mm, 14mm and 25mm respectively, and can be used in total of 7 different combinations to give a variety of magnifications. When used with the standard F1.8 the lens-to-sub-

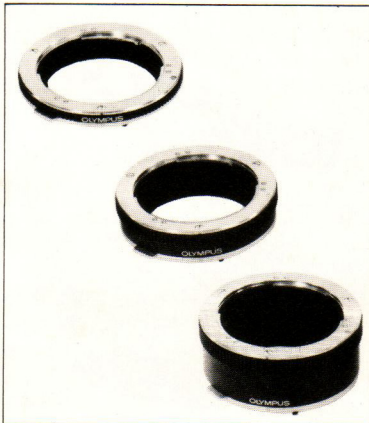

ject distance can be changed from 39.1cm to 6.8cm (15.4" to 2.7"). With the Macro 50mm, the Extension Tube 25 provides an extended magnification range between 0.5x to life-size. (In this range, however, the 1:1 Macro 80mm is recommended for the best result.)

## ■ Copy Stand

A standard type stand, 48 x 44cm, for general close-up and copy photography. Two additional lights can be constructed to the top of the 80cm high stanchion. Fine adjustment for the camera height and a locking device are provided.

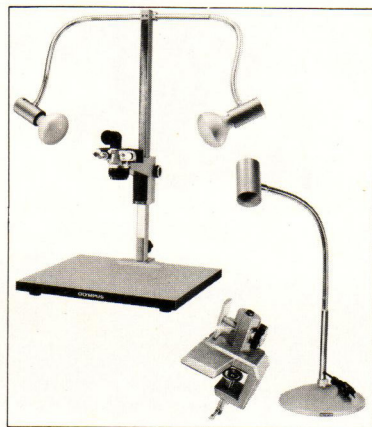

## ■ Lighting Set

Complete with two units each consisting of a stable base and a light arm. Maximum light intensity is 500W.

## ■ Table Clamp

Convenient for setting up the column of the Copy Stand at the edge of a desk or table without the baseboard.



## ■ Auto Bellows

A convenient, high performance bellows system, consisting of the bellows section, focusing rail and focusing tripod mount. Magnification and focusing adjustable independently. A Must for three Macro Lenses. Can also be used with the Focusing Stage.

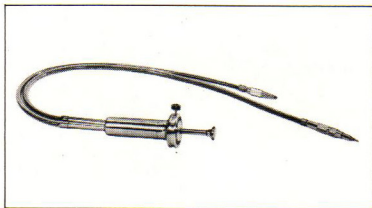
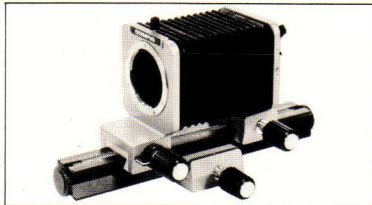

## ■ Double Cable Release

Attached to the Auto Bellows and camera shutter release button, to activate them simultaneously.

## ■ Focusing Rail

This is used with the Focusing Stage and connects to a tripod, the Copy Stand, or Macrophoto Stand B Adapter, so that the camera can be smoothly moved along the Rail, allowing you to focus and compose as desired.

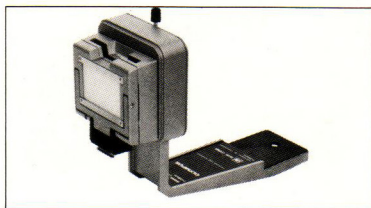
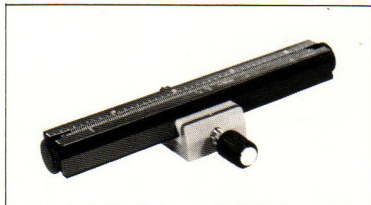

## ■ Slide Copier

For use in conjunction with the Auto Bellows to produce duplicates from frame-mounted slides or strip slides. The 1:1 Macro 80mm is recommended for best results with the Slide Copier.

## ■ Focusing Stage

Allows you to mount the camera body on the Focusing Rail or Auto Bellows. When used with the Rail, you can change the camera position for fast and smooth focusing and composing.

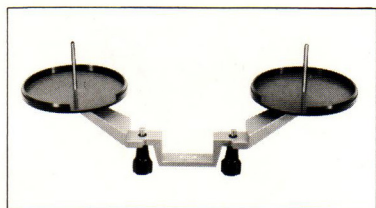
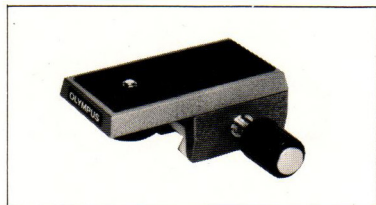

## ■ Roll Film Stage

Attached to the Slide Copier to hold long roll films for duplication.

### ■ Macrophoto Stand VST-1

A rugged stand specially designed for close-up and high magnification photography. Usable with various stage plates. Complete with a round frosted plate (black at back) for incident light and a pair of stage clips.

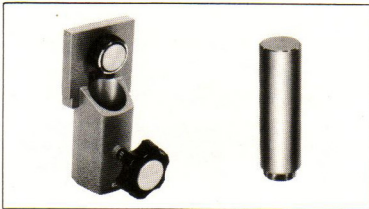

### ■ Macrophoto Stand B Adapter

For use with the Macrophoto Stand, to support the Auto Bellows or Focusing Rail on the Stand.

■ Macrophoto Stand Extension Bar VST-E Extends the height of the Macrophoto Stand. Length: 7.5cm (2.95")

### ■ Trans-Illuminator Base X-DE

Indispensable for holding the Macrophoto Stand VST-1 for magnified photographs. Supplied with a built-in 100V 20W illuminator with a mirror, and a pair of wooden handrests for ease of operation. Can be used with various stage plates and filters. When used with



the Lieberkuhn Reflector, it is convenient to replace the reflector mirror with the Centering Mirror PM-ELCS.

### ■ Cable Release SR-II

For use with the OM Body or Auto Bellows to eliminate shutter vibration at shutter release.

### ■ Epi-Illuminators PM-LSD 2

This pair of illuminators offer vertical illumination essential to macrophotography. The height of the illuminator is adjustable on the tall pillar, suitable to overstage or substage illumination. When used with the Trans-Illuminator Base X-DE, the Illuminator supplies



transmitted light. Focusing is adjustable by shifting the bulb filament. A 6V to 8V variable transformer is provided. Eight filters are available in various sizes, including color, black and white, neutral density, etc. for transparent or translucent subjects.



## ■ Trans-Illuminator LSD

This unit is a universal type trans-illuminator for use with the X-DE Trans-Illuminator Base. When the Lieberkuhn Reflector is added, vertical light is also available. A 6V, 30W bulb is built-in. The condenser travels 18mm by rack and pinion for converging, diverging and



parallel adjustments of light. Complete with transformer and square filter 60 x 45C. Provided with a filter holder for attachment of various OLYMPUS filters, round and square.

- Stage Glasses (Clear, frosted-&-black)
- Stage Plate 45 (metal disc, black)
- Stage Plate 28 (metal disc, black)
- Glass Shade Stage Plate

Supplied with two stage inserts; compatible with the Lieberkuhn Reflector. The center port accepts the stage insert on which a subject is placed.

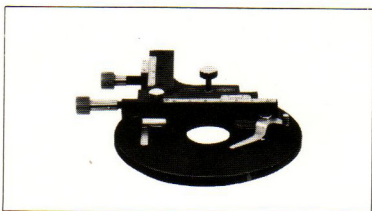
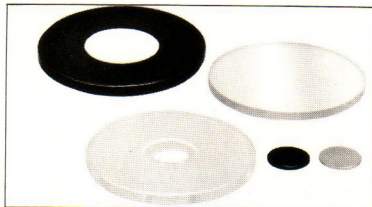

## ■ Mechanical Stage FM

This stage is used to mount subjects on the 28mm stage plate. The subject travels vertically and horizontally by precise adjustments with vernier.

- Spare Bulb 6V 5A TB-1 (for PM-LSD2 & LSD)

- Spare Bulb 6V 5A TP-1 (for PMT-35)
- Adapter PM-EA

Accepts the photosensitive probe of the EMM-7 Exposure Meter in conjunction with the PMT-35 or Auto Bellows.

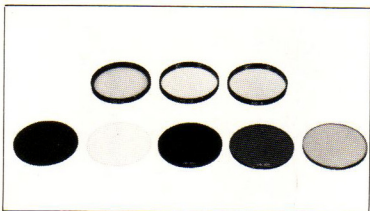

## ■ Filters

Round filters are used with the PM-LSD2 and LSD, while square filters used with the LSD only. They are color temperature compensation, monochromatic, neutral density, diffusion, heat absorbing and interference filters.

■ Lieberkuhn Reflector PM-LM20

■ Lieberkuhn Reflector PM-LM38

These Reflectors are available for use with the 20mm and 38mm Macro Lenses. When used with the LSD Trans-Illuminator, they make it possible to take photographs with excellent penetration and lack of shadows.

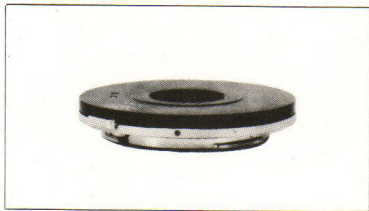
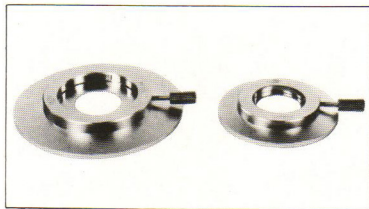

■ Objective Lens Mount PM-MTob

This objective mount enables you to mount the Zuiko Macro 20mm and 38mm to the Auto Bellows. It also connects to the Light Shield Tube PM-SDM.

■ Incident Illuminator Mirror Housings PM-EL80, PM-EL38 and PM-EL20;

These units are used with OLYMPUS Macro Lenses in conjunction with the Epi-Illuminator PM-LSD2 or Macro-photographic Equipment PMT-35 to illuminate macrophotographic objects with incident light. They are effective



when shadowless pictures are desired.

■ Centering Mirror PM-ELCS

For use with these PM-EL units for accurate centration or for use with the Trans-Illuminator Base X-DE.

■ Macrophotographic Unit PMT-35

The PMT-35 is a complete macrophotographic system for OM System photo work providing image magnification from 0.45x to 16.5x with transmitted or reflected light as desired. The standard set consists of 26 out of the 46 high precision units of OLYMPUS macro-

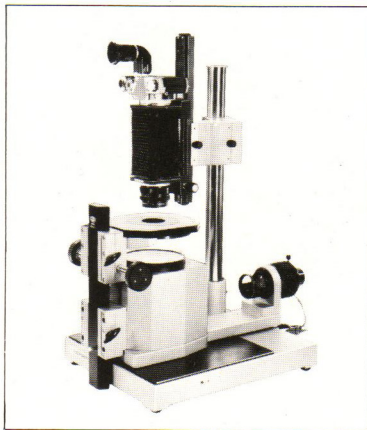

photo equipment. The OM Mount Photomicro Adapter H connects the OM Body to the PMT-35.



When the photographic magnification desired exceeds 10x magnification, it becomes more difficult for the macro-photographic equipment alone to obtain excellent pictures. A sophisticated array of photomicrography accessories with a microscope as the central figure is required. The exciting vision of looking at the microscopic world through a microscope can be recorded by the electronic brain built in the OM-2.

OLYMPUS also has an outstanding reputation for manufacturing precision microscopes used by scientists throughout the world. Naturally, the OM System includes a variety of microscope adapters, rugged stands, a special shutter to prevent vibration at high magnification, and an automatic exposure mechanism, which solves the difficult problem of microscopic exposures.

The Photomicrography Group is designed to expand the photomicrographic world not only into the scientific realm, but also into the creative sphere, so that the photographer's achievements under the microscope can be easily and accurately recorded with his OM-2.

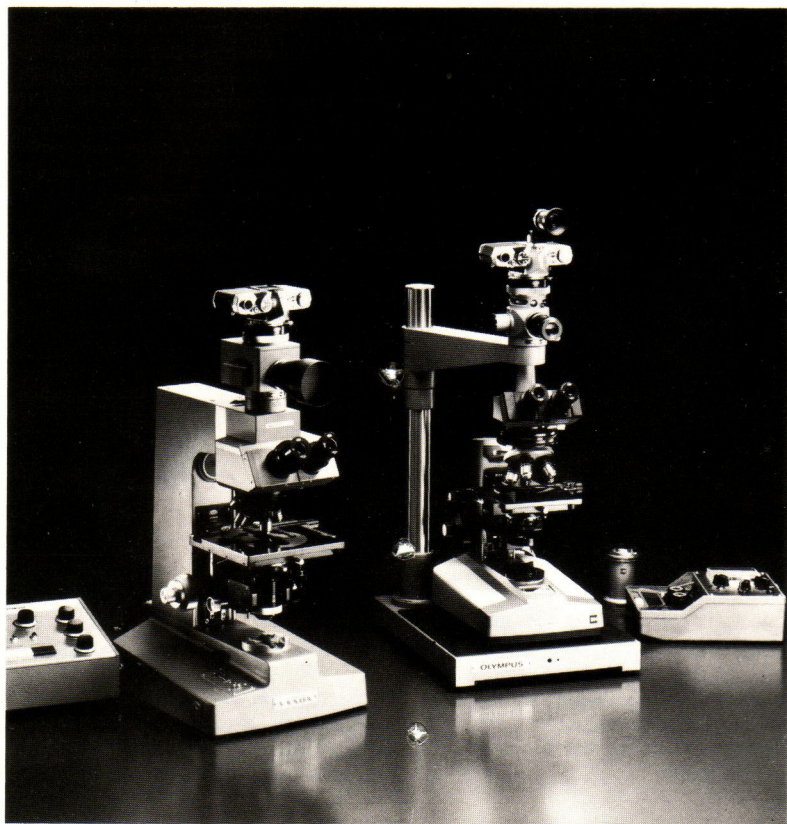





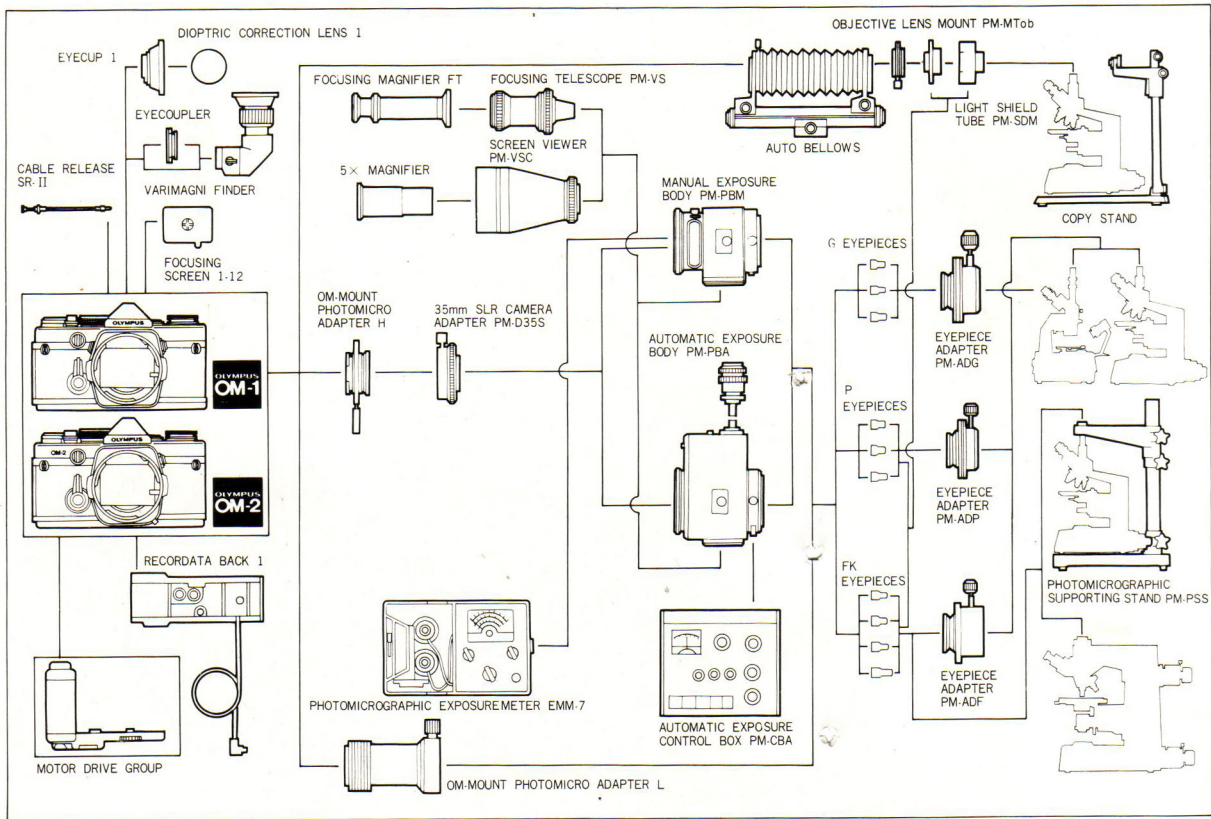

- OM-Mount Photomicro Adapter L**  
 Connects the OM Body to the microscope for low power magnification.



- OM-Mount Photomicro Adapter H**  
 Connects the OM Body to the Photomicrographic System PM-10, automatic or manual, or Macrophotographic Unit PMT-35 for high power magnification.

- 35mm SLR Camera Adapter PM-D35S**

Used with OM-Mount Photomicro Adapter H to attach the OM Body to the PM-PBA or PM-PBM.



- Photomicrographic Supporting Stand PM-PSS**

This unit is a massive stand to virtually end the major cause of lost photomicrographs at high magnification . . . vibration. Supports the entire camera weight, isolating it from the microscope.

- Eyepiece Adapter PM-ADG, PM-ADP, PM-ADF**

Used to connect a microscope to the OM-Mount Photomicro Adapter L, PM-PBA or PM-PBM. Each Adapter designates OLYMPUS microscope eyepieces as follows: PM-ADG for G eyepieces, PM-ADP for P eyepieces and PM-ADF for FK photo eyepieces.

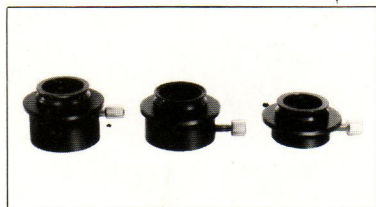

- Light Shield Tube PM-SDM**

Designed for use with the Auto Bellows and Objective Lens Mount PM-MTob. Assures excellent images when used with FK photo eyepieces at the bellows length of 111mm, free of shutter vibration.



# OM SYSTEM PHOTOMICROGRAPHY UNITS

## ■ Auto-Photomicrographic System PM-10-A

Consists of 17 units, including the PM-PBA, PM-CBA, etc.

### ● Automatic Exposure Body PM-PBA

Automatically determines accurate exposure time, compensating for reciprocity failure.

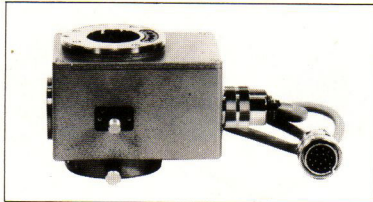

### ● Automatic Exposure Control Box PM-CBA

Used with the Automatic Exposure Body PM-PBA, to regulate color temperatures control. Eight filters provided.

## ■ Manual Photomicrographic System PM-10-M

This is a popular manual version of the PM-10, consisting of 8 units.

### ● Manual Exposure Body PM-PBM

A special shutter release button is integrated to eliminate shutter vibration.

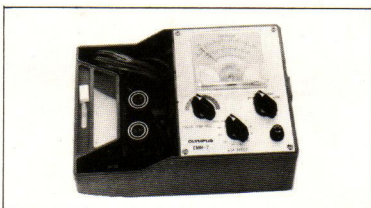
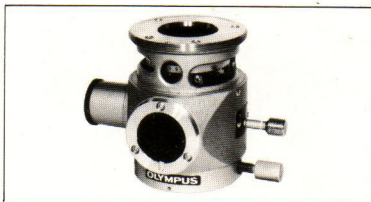

### ■ Photomicrographic Exposure Meter EMM-7

The EMM-7 assures accurate control of both exposure and color temperature in photomicrography. Provided with exposure and color temperature probes, color-compensating filters.

## ■ Screen Viewer PM-VSC

For use with objectives lower than 4x power. A hood is provided to reduce extraneous light on the viewing screen.

### ■ 5X Magnifier

For use with the Screen Viewer for magnifying any part of the subject area and focusing accurately.



### ● Focusing Telescope PM-VS

For use with objectives 4x and up in conjunction with the Automatic or Manual Exposure Body.

### ■ Focusing Magnifier FT

Used to magnify the image obtained by the Focusing Telescope.

# CHART OF PHOTOGRAPHIC RANGES

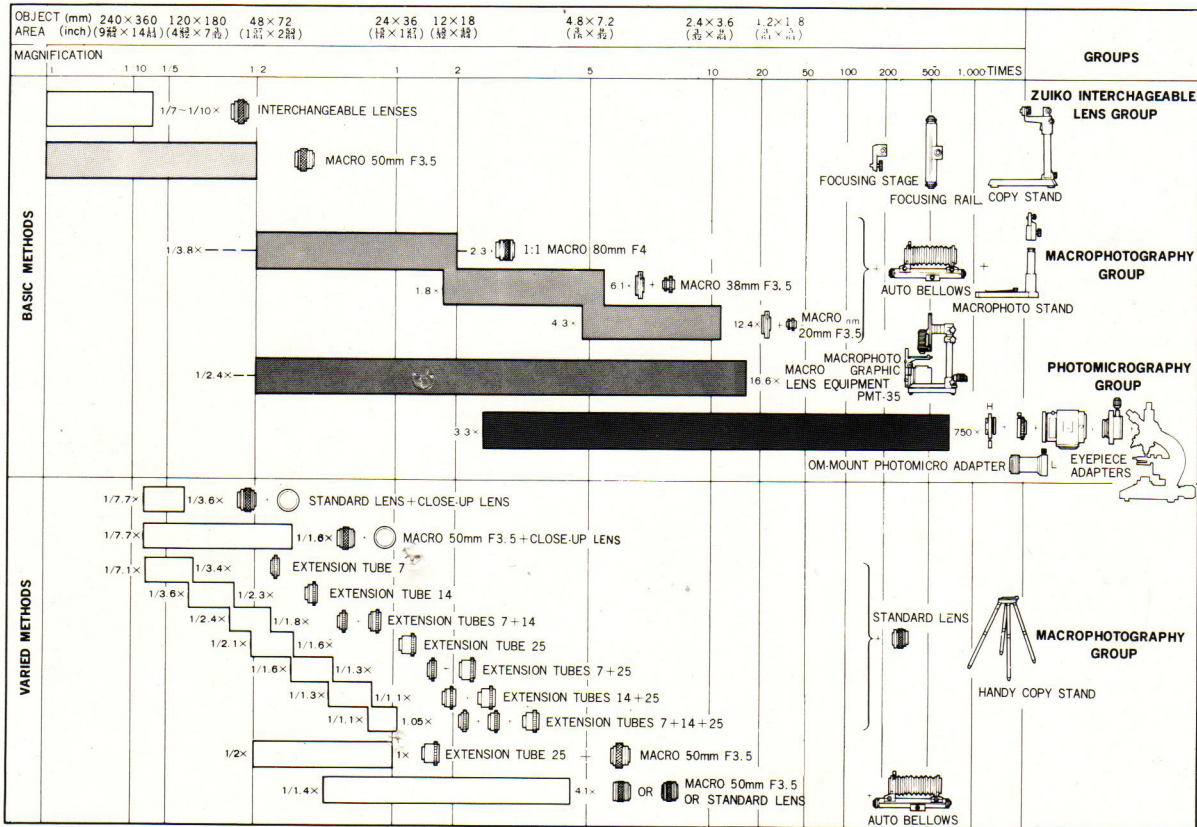





## PHOTOTECHNICAL GROUP

As a leading manufacturer of optical instruments, OLYMPUS has produced a wide variety of microscopes, medical and measuring instruments that have been making a major contribution in many fields of modern life. They are also vital elements in the OM System which many scientists can use to successfully document their achievements in photographs.

OLYMPUS products include fiberoptics that are capable of visualizing the internal view of the human organs and taking photographs for diagnosis and treatment of diseases; operation microscopes for microsurgery; astronomy telescope adapter to explore the mysteries of space and stars — all capable of attachment to the OM Body.

For OLYMPUS Pen F and FT enthusiasts, a mount adapter is available for connection of these cameras to the OM System Interchangeable Lenses and other units. Another outstanding advantage the OM System features is the Recordata Back that is interchangeable with the OM Body camera back. Once in place, the Back imprints numbers directly on the picture when the exposure is made.









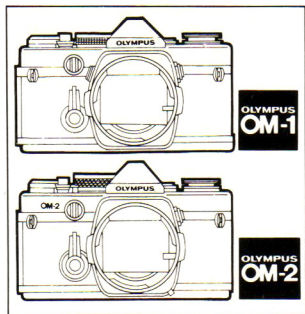

BODY CAP



DOUBLE CABLE RELEASE



CABLE RELEASE SR-II

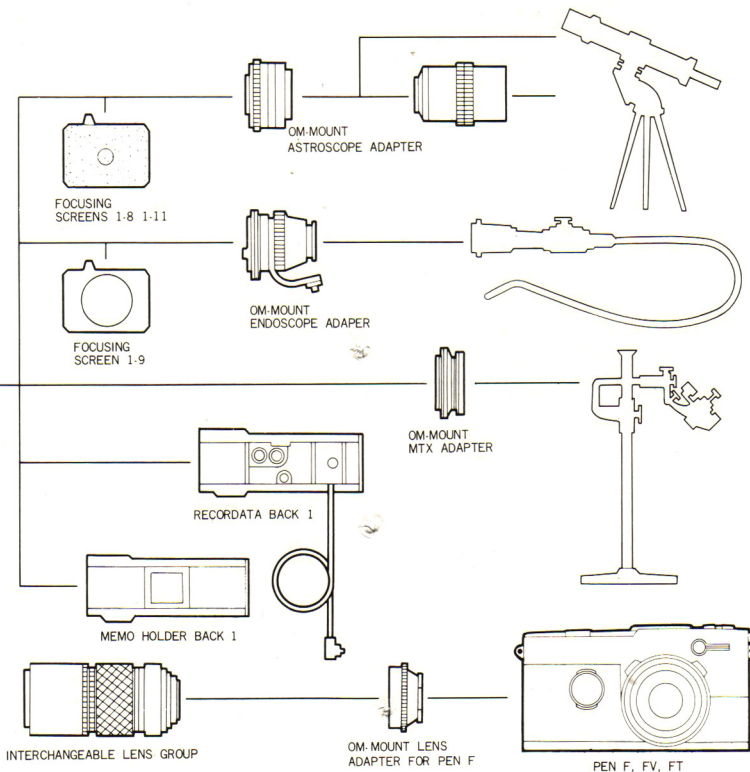

## ■ Recordata Back 1

Used as a replacement camera back of the OM Body, the Recordata Back makes provision to imprint data such as date, numbers, etc. directly on the pictures. Provided with a built-in light emitting diode powered by three 1.5V silver oxide batteries. It measures only



28mm (1.1") in thickness, weighing 95g (3.4 oz.) without batteries.

## ■ OM-Mount Astroscope Adapter

Permits astrophotography by the OM Body attached to a telescope by means of the 36.5mm diam., pitch 1mm and pitch 0.75mm threads. It enables direct objective photography and high magnification photography through the telescope eyepiece.



## ■ OM-Mount Endoscope Adapter

Used for mounting the OM Body to the OLYMPUS fiberscopes except the gastrocameras. The clear field type Focusing Screen 1-9 is recommended for use with this adapter.

## ■ OM-Mount MTX Adapter

Its bayonet mount facilitates mounting the OM Body on the OLYMPUS Operation Microscope MTX.



## ■ OM-Mount Lens Adapter for Pen F

Connects the OLYMPUS PEN F, FT and FV cameras to the OM System Interchangeable Lenses and other units.

## ■ Double Cable Release

Used with the Auto Bellows.

## ■ Cable Release SR-II



However ruggedly constructed, the camera is essentially a precision instrument and should be kept away from abrupt motions as much as possible. On the other hand, various units require rapid changing in actual use. Replacement of interchangeable lenses, for example, may have to be carried out quickly to meet changing photographic conditions.

The outstanding versatility of a true system camera can be enhanced if it is easy to operate and carry. With a properly designed case, both carrying and using your equipment becomes more convenient.

The OM System Case Group includes a large variety of cases so that the OM Body and other units may fit properly. They are compartment cases, specially made of tough synthetic leather, and designed to perfectly accommodate the photographic units. The adjustable partitions can be rearranged in the case to suit the photographer's individual requirements. Soft, hard and semi-hard cases to fit the OM Body and standard lenses, with a choice of carrying straps, are also available.

■ **Hard Case for OM Body with F1.8 or F1.4**

■ **Hard Case for OM Body with F1.2**  
Accommodates the OM Body with respective standard lens.

■ **Semi-Hard Case for OM Body with F1.8 or F1.4**



■ **Semi-Hard Case for OM Body with F1.2**

■ **Soft Case for OM Body with F1.8 or F1.4**

Accommodates the OM Body with F1.8 or F1.4 standard lens, and the Recordata Back 1.

■ **Soft Case for OM Body with F1.2**

■ **Lens Pouch 100**

Made of fine leather to contain a single lens 100mm or smaller.

■ **Lens Pouch 200**

A fine leather container for a telephoto lens 200mm, zoom lens, or smaller. The main body of the Quick Auto 300 can also be contained.

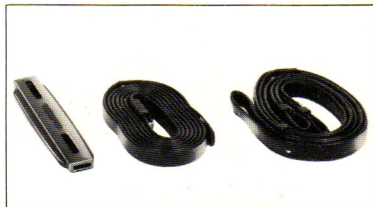

■ **Leatherette Shoulder Strap with Shoulder Pad 1**

■ **Leather Shoulder Strap with Shoulder Pad 2**

■ **Flat Braid Shoulder Strap**

■ **Round Braid Shoulder Strap**

■ **Compartment Case S**

A hard shoulder case with two adjustable partitions. Holds OM Body, two interchangeable lenses and filters, or Quick Auto 300, Bounce Grip and OM Body can be contained.



■ **Compartment Case M**

A soft shoulder case with partitions and two pockets. Holds OM Body, three interchangeable lenses and various auxiliary equipment including electronic flash. Straps for carrying tripod.



■ **Compartment Case L**

A hard shoulder or hand-carried case with two adjustable partitions. Holds two OM Bodies, two interchangeable lenses (including 300mm telephoto lens), electronic flash, large format camera, and other equipment.



■ **Partitioned Insert**

When inserted into the Compartment Case L, this unit supports the assembly of the Motor Drive Units. The 250 Film Back 1 and interchangeable lenses can be contained together with the OM Body.



**(Continued from page 12.)**

\* When setting the aperture ring, you may use either the click-stop positions or any in-between settings to obtain precise exposure control.

\* All lenses in the OM System (except certain specialized lenses) provide fully automatic diaphragm control allowing you to focus and compose your picture with the lens fully open. The diaphragm will automatically change to the pre-selected F stop at the moment of exposure and immediately re-open when the exposure is completed.

\* For automatic exposure, the F stop is reset on the lens aperture ring and the camera selects the shutter speed for the lighting conditions in the scene. (Refer to page 15.)

**(Continued from page 20.)****② Strong Frontlighting and Deep Shadows**

When taking a picture of a bright subject against a dark background (spotlighting, deep shadow areas, etc.) the meter has a tendency to read the darkest part of the picture leaving the main subject over-ex-

**(Continued from page 13.)****■ Caution for the use of manual shutter speed ring under automatic exposure control.**

Under auto exposure control, irrespective of the shutter speed setting, the electronic shutter automatically selects the optimum shutter speed from about 60 seconds (ASA 100, at normal temperature and humidity) to 1/1000 second except B, where the shutter works manually. Be careful that at B the shutter remains open for a long time exposure in a dark place even after freeing the shutter release button.

posed. To compensate for this use the same procedure for setting exposure as outlined for backlighting. You can also approximate the proper exposure by holding your position and setting an F stop/shutter speed combination which causes the meter needle to indicate one full stop of under-exposure.

**(Continued from page 16.)**

\* When the selector lever is set to the "AUTO" position, rotating the manual shutter speed ring does not affect the shutter speed automatically set by the camera. "AUTO" operation is interrupted only when the ring is set to the "B" setting.

\* Do not advance the film while the mirror is up during an automatic exposure. If this should occur, sometimes the mirror will lock-up and the camera will no longer operate. In that case the "RESET" procedure must be used to unlock the mirror. (See page 7.)

**(Continued from page 26.)**

\* The meter needle does not indicate proper exposures for manual exposure photography when the 1-5, 1-6, 1-7, or 1-9 Focusing Screens are used, although they produce an extremely bright viewfinder image. Proper exposures are obtained with these Screens in automatic photography, however, the shutter speed scale in the viewfinder does not give an accurate indication of the actual shutter speed used during exposure.



# MAIN SPECIFICATIONS

Specifications subject to change without notice.

**System:** OLYMPUS OM System.

**Camera type:** 35mm Single Lens Reflex with automatic exposure control electronic focal plane shutter.

**Film format:** 24mm x 36mm.

**Film mount:** OLYMPUS OM Mount, bayonet type; rotation angle 70°, flange back 46mm

**Shutter:** Focal plane shutter, automatic exposure control from about 60 seconds to 1/1,000 second (ASA 100, F1.2, at normal temperature and humidity). Manual exposure: B, 1—1/1,000 sec., ring mounted control.

**Synchro:** FP-X switch type contact, incorrect flash prevention.

**Automatic exposure control:** Aperture-preferred automatic exposure control electronic shutter type. TTL Direct Light Measuring System, center-weighted for bright, and averaging for dark conditions. Measuring range: ASA 100 from F1.2, about 60 seconds to F16, 1/1,000 second. (about EV 5.5 — EV 18) (at normal temperature and humidity). Light sensors: 2 SBC sensors. Large exposure compensation dial: ±2EV (within the ASA film speed range). Automatic flash exposure: Direct contacts for TTL Auto Flasf.

**Manual exposure:** TTL type. Measuring system: Full aperture center-weighted metering. Measuring

range: EV1.5—EV17 (ASA 100 with F1.2 standard lens). Light sensors: 2 CdS sensors.

Zero-method with needle visible in viewfinder.

**Film speed setting:** ASA 12—1600, set by lifting and rotating film speed dial.

**Auto/Manual selection:** By selector lever.

**Battery check:** 3-stage battery check lamp (light emitting diode) indicates full voltage, depleted charge, and exhaustion of batteries. Shutter lock to limit drainage.

**Power source:** Two 1.5V silver oxide batteries [Eveready (or UCAR) S-76 or equivalents].

**Viewfinder:** Pentaprism type wide-vision finder.

**Focusing screens:** Wide selection of interchangeable screens. Standard type Focusing Screen 1-1 (microprism-matte type).

**Finder view-field:** 97% of actual picture field.

**Apparent field view:** Vertical 23° 30', horizontal 35°.

**Indicators in viewfinder:** 3-stage selector lever. (Auto: Shutter speed indicator. — Manual: exposure index. — Off: nothing).

**Reflex mirror:** Oversize, quick return type (without lock-up).

**Film loading:** OLYMPUS easy loading.

**Manual film advance:** Lever type with 150° angle for one long or several short strokes, pre-advance angle 30°, self cocking, double advance and double exposure prevention.

**Motor drive advance:** With Motor Drive 1 unit attached, single frame and continuous advance at speed of 5-frame per second (at exposures above 1/500 sec., with fresh batteries and at normal temperature and humidity).

**Exposure counter:** Progressive type with automatic reset.

**Film rewind:** Crank type, with rewind release lever setting, automatic return.

**Self-timer:** 4—12 second delay lever type with 180° maximum angle, can be stopped and reset after actuation.

**Camera back:** Removable hinge type, with memo holder.

Interchangeable with Recordata Back 1 and 250 Film Back 1.

**Hot shoe socket:** OLYMPUS accessory shoe (optional) attachable.

**Dimensions and weights:**

Body only: 136x83x50mm (5.35"x3.27"x1.97") 520g (18.3 oz)

With F1.8 lens: 136x83x81mm (5.35"x3.27"x3.19") 690g (24.3 oz)

With F1.4 lens: 136x83x86mm (5.35"x3.27"x3.39") 750g (26.5 oz)

With F1.2 lens: 136x83x97mm (5.35"x3.27"x3.82") 830g (29.3 oz)



**OM**  
SYSTEM

**OLYMPUS**

**OLYMPUS OPTICAL CO., LTD.**

43-2 Hatagaya 2-chome, Shibuya-ku, Tokyo Japan