

# WILSONWERKS ARCHIVES

This camera manual is for reference and historical purposes, all rights reserved.

This cover page is copyrighted material. This document may not be sold or distributed without the express consent of the publisher.

©2008 wilsonwerks Llc

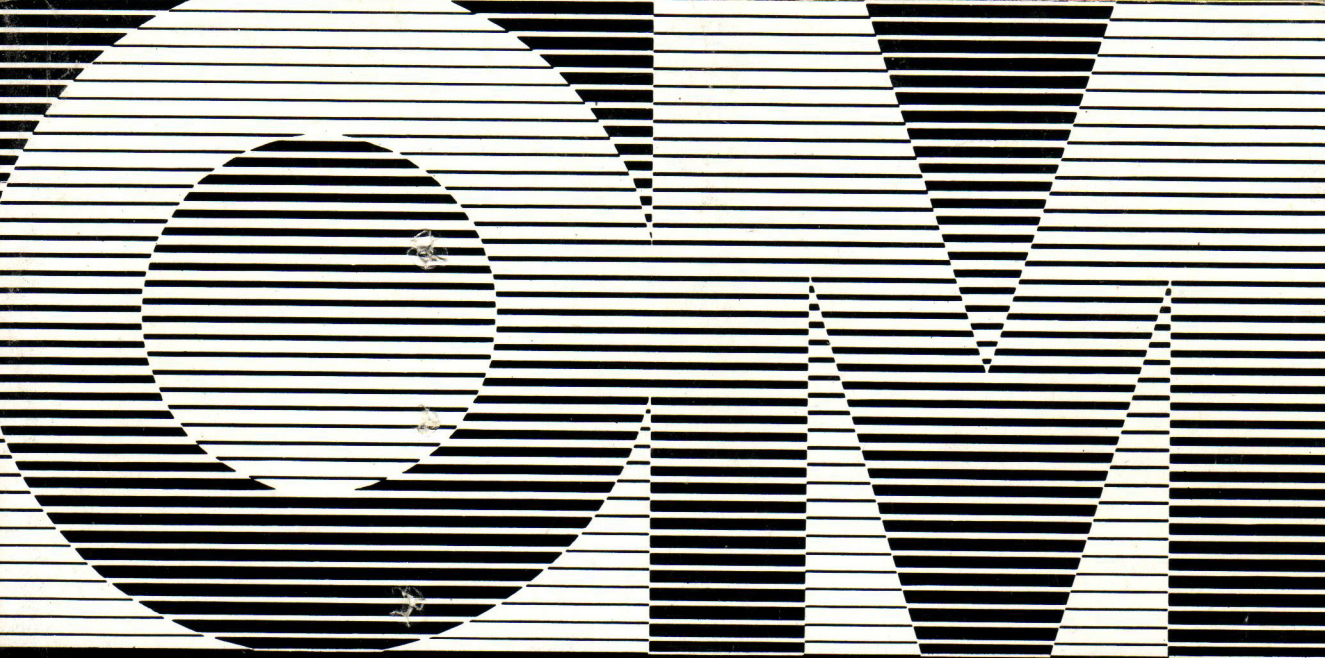

U

**OLYMPUS**

**OM**  
SYSTEM

**QUICK AUTO 310**  
■ OPERATING INSTRUCTIONS

The Olympus Quick Auto 310 is the world's first electronic flash unit that offers the accuracy and convenience of using your Olympus OM-2's Through-The-Lens Direct Light Measuring system to automatically control flash exposures. Exposure is controlled by the light reaching the film rather than an independent sensor which may view a different area from the camera lens.

In addition to this epoch-making method dubbed by Olympus "TTL Centralized Control Flash" or "TTL Auto" for short, the Quick Auto 310 is equipped for regular Automatic Exposure Control as well as Manual Flash operation. As an integral part of the OM System Flashphoto Group, The Quick Auto 310 can be adapted to all your creative photographic needs.

## Quick Auto 310 Flash Photography

Camera	Flash Holder	Dial Setting	Flash Mode					Remark	
			Direct	Bounce	Close-up	Ultra High-speed	Daylight Fill-in		
OM-2 (Selector lever setting)	A U T O	Accessory Shoe 2	TTL AUTO	○		○*	○	△	* with TTL Auto Cord 0.6m
		Bounce Grip + Accessory Shoe 2	TTL AUTO	○*	○*	○*	○*	△*	
	M A N U A L	Accessory Shoe 1 or 2	NORMAL AUTO	△			△	△	
		Bounce Grip	NORMAL AUTO	△	△		△	△	
		Accessory Shoe 1 or 2	MANUAL	△				○	
	Bounce Grip	MANUAL	△				○		
OM-1 (& other cameras)	Accessory Shoe 1	NORMAL AUTO	○			○	△	* with Remote	
	Bounce Grip	NORMAL AUTO	○	○★		○	△	Sensor	
	Accessory Shoe 1	MANUAL	△				○		
	Bounce Grip	MANUAL	△				○		

○ = Recommended; △ = Feasible



## INTRODUCTION

- Description of Controls . . . . . 4
- Main Specifications . . . . . 6
- Basic Flash Units Combination . . 7
- Loading the Batteries . . . . . 8

## WITH OM-2

- Mounting on the OM-2 . . . . . 10
- TTL AUTO Flash with OM-2 . . . 11
- TTL AUTO Flash in Special Situations with OM-2 . . . . . 14
- High-technique TTL AUTO Flash with OM-2 . . . . . 15
- NORMAL AUTO Flash with OM-2 . . . . . 17
- MANUAL Flash with OM-2 . . . . 17
- High-technique MANUAL Flash with OM-2 . . . . . 18

## WITH OM-1 (& OTHER CAMERAS)

- Mounting on the OM-1 . . . . . 20
- NORMAL AUTO Flash with OM-1 . . . . . 21
- NORMAL AUTO Flash in Special Situations with OM-1 . . . . . 25
- High-technique NORMAL AUTO Flash with OM-1 . . . . . 26
- MANUAL Flash with OM-1 . . . . 27
- Daylight Fill-in Flash . . . . . 30
- Chart of OM System Flashphoto Group . . . . . 31





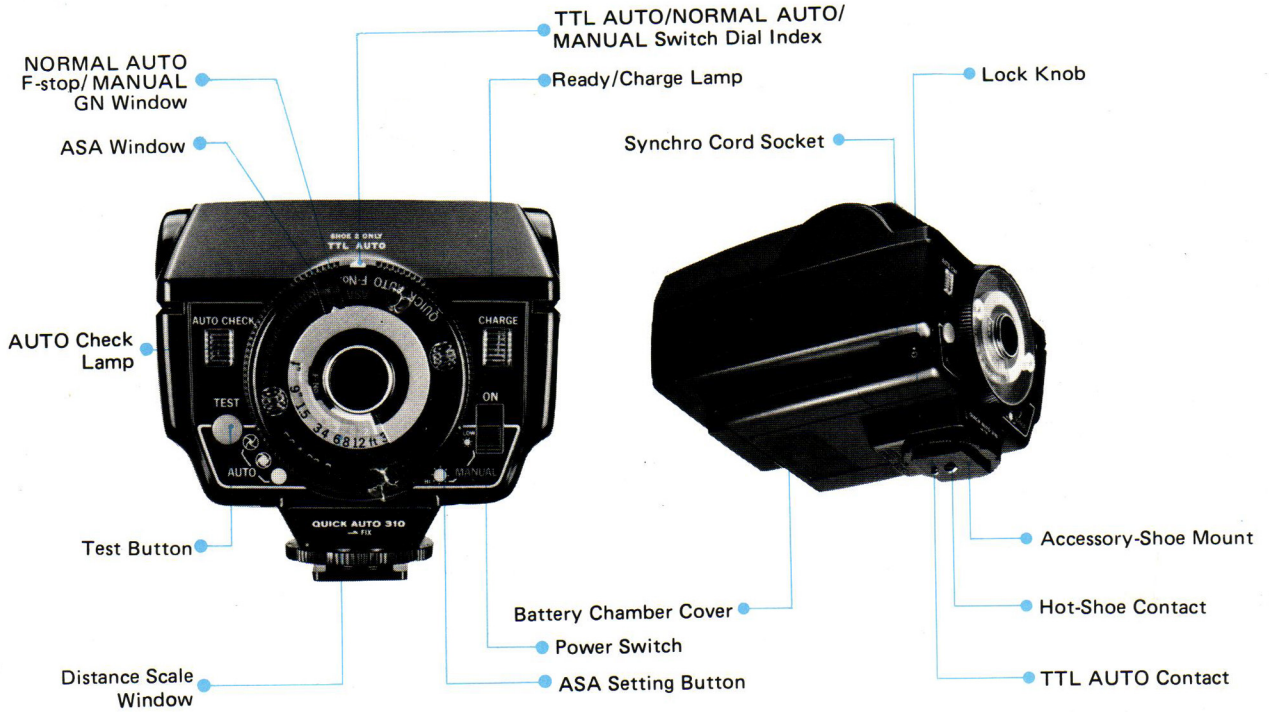

- **Type:** Energy-saving, series-circuit type TTL automatic exposure, system electronic flash unit
- **Guide Number:** 55 at peak (ASA 25, ft) or 34 at peak (ASA 100, m)
- **Coverage Angle:** 50° vertical, 80° horizontal
- **Flash Duration:** 1/40,000–1/1,000 sec.
- **Recycling Time:** 0.2–12 sec. with AA alkaline batteries
- **Flashes per set of AA Alkaline Batteries:** 100 ~ over 400 on TTL AUTO and NORMAL AUTO (varies depending on flash-to-subject distance).
- **Color Temperature:** 5,800° K
- **Connection to Camera**
  - Mechanical:** Clip-on type (via accessory shoe) or grip type (via Bounce Grip)
  - Electrical:** Direct contact (hot shoe), or via Auto Cord or Synchro Cord
- **Dial Setting:** TTL AUTO/NORMAL AUTO/MANUAL rotating dial
- **TTL AUTO**
  - Aperture Setting:** Continuous, accords with aperture ring setting of camera-linked lens
  - SBC Sensor Acceptance Angle:** Accords with view of angle of camera-

linked lens

**Working Range:** 10in. (ASA 100, F16) – 75ft (ASA 100, F1.2) with self-setting distance scale.

**TTL AUTO Check:** Neon-flicker (approx. 5 sec. after flash)

**Bounce Flash:** Bounce Grip + TTL Auto Cord 0.6m

● **NORMAL AUTO**

**Aperture Setting:** Choice of 3 apertures (F4, F5.6 and F8 at ASA 100, for example)

**Normal Auto Sensor Acceptance Angle:** Approx. 20°

**Working Range:** 20in\*\* – 28ft (ASA 100) with self-setting distance scale

**AUTO check:** Neon-flicker (approx. 5 sec. before or after flash)

**Bounce Flash:** Bounce Grip + Remote Sensor

● **Manual Flash Guide Numbers:** HI–55, LOW–27 (ASA 25, ft)

● **Test Button for NORMAL AUTO Check & Open Flash:** Push-button type

● **Power Source Options:** ① Self-contained 1.5V AA penlight battery x 4 (excluding NiCads) ② 1.5V C battery x 4 in Bounce Grip (excluding NiCads)  
Combination ①②

● **Size and Weight:** 3 7/8 x 3 1/8 x 2 7/8", 11.6 oz (less batteries) (99 x 80 x 73mm, 330g)

\* At minimum autoflash working distances on TTL AUTO and NORMAL AUTO, where the least amount of flash light is required; e.g., at a flash-to-subject distance of 20in. at F8 (ASA 100).

\*\* At a flash-to-subject distance of 3 feet and closer, it is recommended to set the f/stop to 8 (ASA 100).



**OLYMPUS**  
**OM-2**

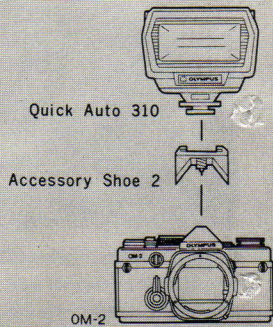

**OLYMPUS**  
**OM-2**

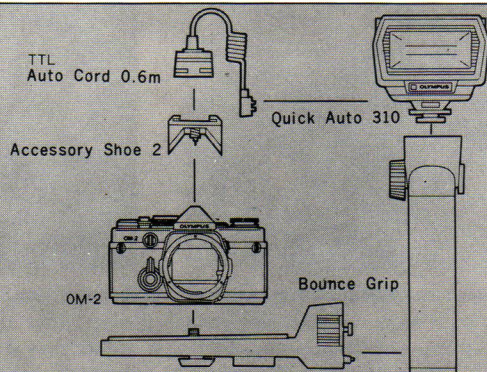

**OLYMPUS**  
**OM-1**

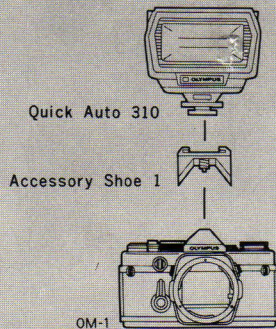

**OLYMPUS**  
**OM-1**

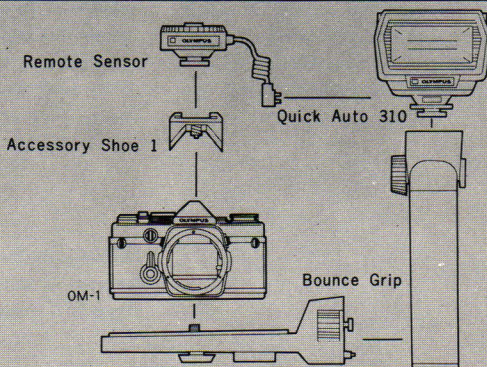



**1. Remove the Battery Chamber Cover.**

Slide the Cover in the direction of the arrow.

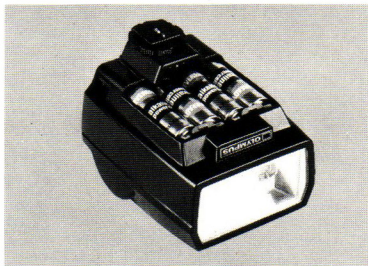

**2. Insert the Batteries.**

Insert four 1.5V AA size batteries properly as indicated by the polarity marks  $\oplus$  and  $\ominus$ .

\* Use all fresh batteries. Mingling an old one will shorten overall battery life.

\* Alkaline batteries are recommended, since they will last about 4 times as long as the Manganese type.



**3. Replace the Battery Chamber Cover.**

Align the cover to both edges of the Battery Chamber and push in until it snaps into place.

**Nickel-cadmium batteries should not be used as they will damage the Quick Auto 310 circuitry.**



OM-2

FOR USE WITH OM-2

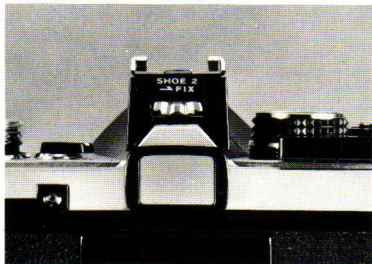

**1. Attach the Accessory Shoe 1 or 2 to the OM-2.**

- 1) With Accessory Shoe 2  
TTL AUTO, NORMAL AUTO and MANUAL methods are available.
- 2) With Accessory Shoe 1  
NORMAL AUTO and MANUAL methods are available. (See page 17.)



**2. Mount the Quick Auto 310 on the accessory shoe.**

Slide the Quick Auto 310 into the accessory shoe as far as it will go, and tighten the Lock Knob in the direction of the arrow ("FIX").

- \* Use a coin or similar item to tighten the Lock Knob firmly.
- \* On cameras with a hot shoe, the synch circuit is automatically completed when the flash unit is mounted.

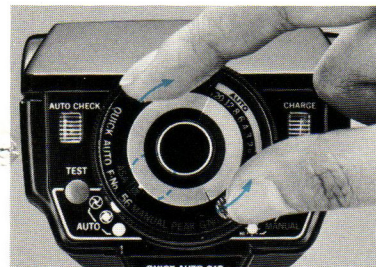

**3. Set the ASA film speed.**

Rotate the Switch Dial until the proper ASA rating for the film being used appears in the ASA Window, using the ASA Setting Buttons.

\* During TTL AUTO flash operation, the SBC sensors built into the OM-2 body are used to measure the light returning from the subject. Since the NORMAL AUTO Sensor built into the Quick Auto 310 is not used, there is no need to set the film speed or aperture on the unit. **However**, by setting the ASA film speed, the self-revealing Distance Scale can be used.

\* At NORMAL AUTO and MANUAL flash operation, be certain to set the film speed properly; if not, correct exposures cannot be made.



1. Set the camera's selector lever to the "AUTO" position.

\* Be certain the lever is set at the click-stop position.



2. Set the camera's synchronization terminal to "X".

Turn the red index of the X and FP flash selector opposite to the "X"; the synch circuit will be turned to "X" setting.

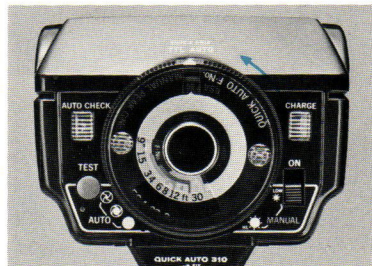

3. Set the Switch Dial to the "TTL AUTO" position.

Rotate the Switch Dial counter-clockwise until the white triangle is aligned with the white line.

\* The TTL AUTO flash will function properly only at the click-stop position.



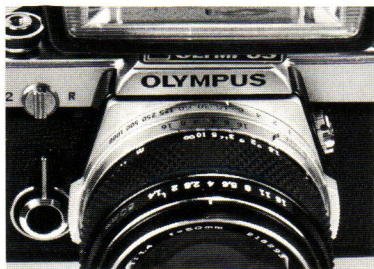

#### 4. Set the f/stop with the camera's aperture ring.

- 1) Focus on your subject to determine the camera-to-subject distance.
- 2) Any setting between the maximum and minimum apertures of the camera-linked lens can freely be selected as far as it is within the TTL

(ASA 100)

Distance	F/Stop	Working Range
Far	1.2	11 ft.—75 ft.
	2	6.5 ft.—46 ft.
	2.8	4.5 ft.—32 ft.
Medium	4	42 in.—23 ft.
	5.6	27 in.—16.5 ft.
	8	20 in.—11.5 ft.
Close	11	14 in.—8 ft.
	16	10 in.—6 ft.
	22	7 in.—4.25 ft.

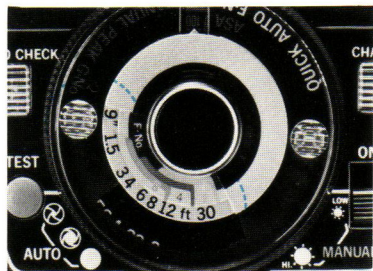

#### AUTO working range.

The table below indicates approximate TTL AUTO distances corresponding to individual f/stops. Select a suitable f/stop based on the table.

- 3) The TTL AUTO working ranges (in feet) appear in the Distance Scale Window at the bottom left of the Switch Dial for quick consultation.

\* If the subject is beyond the TTL AUTO range, set the aperture ring at a larger f/stop or move in closer to the subject.

\* Conversely, if the subject is closer than the minimum working distance, reverse the above procedure.

\* The Test Button for before-flash auto check cannot be used during TTL AUTO operation.

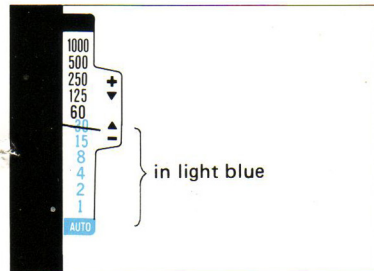

#### 5. Check the shutter speed.

- 5) Aim the subject and check to see if the meter needle points a shutter speed slower than 1/30 sec. (speeds indicated in light blue). If the shutter speed is out of the light-blue range, rotate the aperture ring for a smaller f/stop until the meter needle comes in the range.
- \* If the shutter speed is faster than the synchronizing time, the electronic flash unit will not fire when you press the shutter release button.

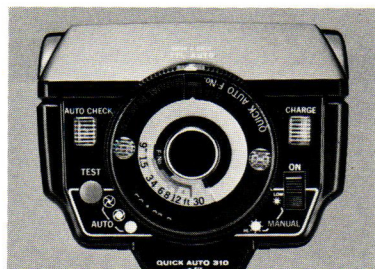
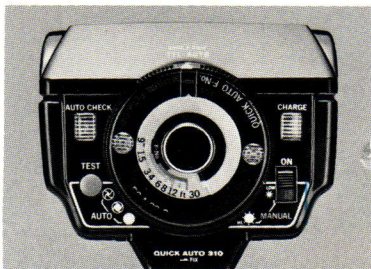

#### 6. Turn the Power Switch to ON.

Wait for the Ready/Charge Lamp to glow.

When the Quick Auto 310 is used with a 24-mm super wide-angle lens, marginal light falloff on the picture may sometimes be caused due to the difference between the area viewed by the lens and the area lit by the flash. Particularly at close distances shorter than 5 ft. or when taking a subject of an overall flat surface, e.g., a white wall, shading around the upper or bottom edge of the picture is likely to occur. Care should be exercised to overcome the parallax by using the Bounce Grip, etc.

#### 7. Press the shutter release button.

\* When correct exposure is made, the closing curtain travels across the film plane as soon as the flash duration is over regardless the shutter speed indication in the viewfinder.

\* If this is not the case, the amount of flash light is insufficient (beyond TTL AUTO range).

If you want to continue TTL AUTO flash operation without altering much of the situation: (1) approach to the subject; (2) select a larger f/stop; or (3) switch the OM-2's selector lever to "OFF" — a shade underexposure, perhaps, but no blurring (only at ASA 25 ~ 200).

has been made.

#### 9. Turn off the Power Switch.

#### 8. Check to see if correct exposure is made.

When the correct exposure is made, the Auto Check Lamp flickers. (When the Auto Check Lamp does not flicker indicating that the subject was beyond the maximum operating range, wait for the shutter to close before attempting to advance the film.)

\* The flickering of the Auto Check Lamp, even when the Ready/Charge Lamp is not lit as in consecutive flashing, also indicates that correct exposure has been made.

\* A flash-to-subject distance of less than 10 in. at f/16 ASA 100 (14 in. at f/11, 20 in. at f/8, and so on) is outside the TTL AUTO operating range. The flickering of the Auto Check Lamp in such a case does not indicate that the correct exposure



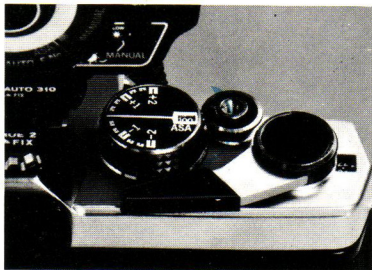

### 1. Intentional over- and under-exposure

To over-expose intentionally, turn the exposure compensation dial to the plus (+) side.

To under-expose intentionally, turn the dial to the minus (-) side.



### 2. Portrait with night sky in the background

When the subject is not in the central part of the finder and surrounded with dark background such as night sky, or when the background is so far away to take pictures with the flash light, over-exposure may result. In such a case, turn the exposure compensation dial to  $-1 \sim -2$ .



### 3. Portrait with white walls at back

Generally, when a white back such as white walls occupies the greater part of the picture or when a large white table is in front of the subject, the sensors tend to see the intense reflected light from it. In a situation like this, turn the exposure compensation dial to  $+1 \sim +2$ .

\* The exposure compensation dial functions properly only at the click-stop settings.

\* The shutter speed will vary in response to the dial operation; recheck the shutter speed. (See Step 5, page 12.)

\* After taking a picture, make sure you return the dial to the normal setting.



### 1. Bounce TTL AUTO flash

The TTL Centralized Control flash makes bounce and diffuse flash techniques as easy as direct flash.

The bounce flash technique produces realistic, subdued lighting effects. Using the Bounce Grip and TTL Auto Cord 0.6m, simply aim the Quick Auto 310 at a convenient ceiling or wall to illuminate your subject with an even glow of reflected light.

Since the amount of light reaching the subject varies with the bounce angle and distance as well as the reflectivity of the wall or ceiling, you should open the lens aperture 2 or 3 stops larger than the f-stop indicated on the Distance Scale.

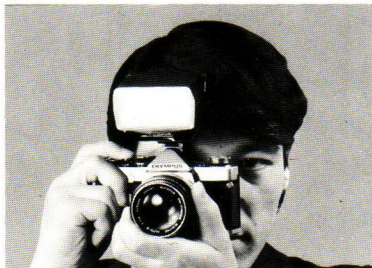

### 2. Diffuse TTL AUTO flash

Diffuse flash light is used to soften illumination when you want to use a large aperture at close range or when shooting with a wide-angle lens with a focal length less than 24mm.

Cover the Quick Auto 310 Flash Lens with tracing paper or white cloth. The camera's Through-the-lens metering system will compensate for any reduction in light output and compute correct exposure.

Since the amount of light reaching the subject will vary with the light transmission characteristics of your diffusion material, you should open the lens aperture 1 to 3 stops larger than the f-stop indicated on the Distance Scale.

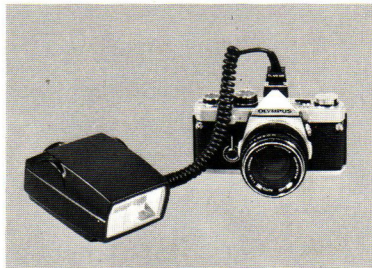

### 3. Close-up TTL AUTO flash

1) In close-up and macrophotography that use the extension tube, close-up lens or auto bellows, the on-camera flash unit will produce shading due to parallax or eclipse due to the elongated lens barrel.

To solve these problems, the flash unit must be separated from the camera and connected with the optional TTL Auto Cord 0.6m to illuminate the object from an appropriate off-camera position.

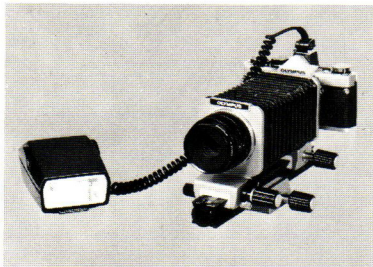

- 2) Select the f/stop referring to the table on page 12.

Closest TTL Auto Distance (ASA 100)

Lens aperture	4	5.6	8	11	16	22
Flash-to-object distance (in.)*	42	27	20	14	10	7

\*Distance: Not Camera-to-object.

(Extracted from table, page 12)

- \* The diffuse flash technique allows you to shorten the above closest distances further.



#### 4. Ultra high-speed TTL AUTO flash

In this technique, a short flash duration is used to stop high-speed motions. The auto electronic flash is designed to further cut off the already short flash duration to achieve proper exposures. In close-up, a duration of up to 1/40,000 second is available to freeze objects moving with ultra high-speed, such as the flying bee and milk crown. At each f/stop setting, the fastest flash duration is available at the minimum working distance.

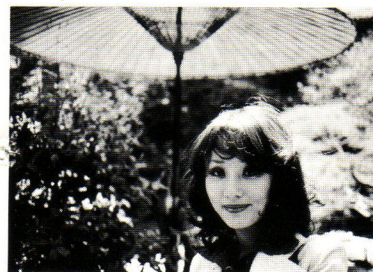

#### 5. Daylight fill-in TTL AUTO flash

Daylight fill-in on TTL AUTO is feasible, but limited to a considerable extent by the natural light and subject conditions. This method is practical when the main subject, e.g., a model, occupies most part of the central area of the focusing screen, or when ambient light is relatively dim.

- 1) Determine the f/stop so that the meter needle points around 1/30 sec.
- 2) Make sure the selected f/stop satisfies the TTL AUTO flash range. (See Step 4, page 12.)



The Quick Auto 310/OM-2 combination offers the fastest kind of operation and outstanding performance on TTL AUTO. In the following cases, however, NORMAL AUTO method (ordinary, non-TTL autoflash) must be conducted.

- 1) On-camera flash linked with Accessory Shoe 1
- 2) Off-camera flash linked with Bounce Grip (in case TTL Auto Cord 0.6m is not available)



1. Set the camera's selector lever to "MANUAL".
2. Set the ASA film speed on the Quick Auto 310. (See page 21.)
3. Set the camera's shutter speed control. (See page 21.)
4. Set the camera's synchronization terminal to "X". (See page 21.)
5. For following procedures, see pages 22-24.

To make more interesting pictures, the MANUAL method is highly useful particularly in daylight filling-in. (See page 18.)

1. Set the camera's selector lever to "MANUAL".
2. Set the ASA film speed on the Quick Auto 310. (See page 21.)
3. Set the camera's shutter control. (See page 21.)
4. Set the camera's synchronization terminal to "X". (See page 21.)
5. For following procedures, see pages 27-29.

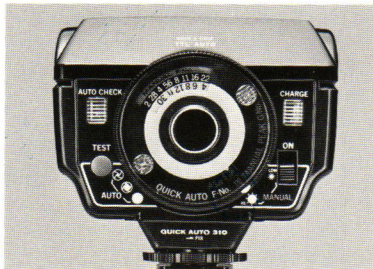

### 1. Daylight fill-in flash

- 1) Determine the amount of light output and set the Switch Dial.

In general, this technique will be used in bright daylight so, in most situations, the HI setting will be used. (See page 27.)

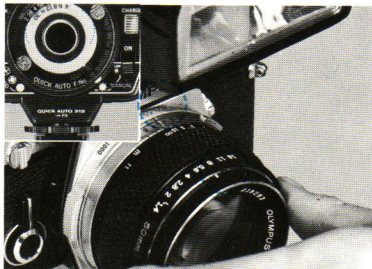

- 2) Set the aperture of the camera-lens.

Read the F-number corresponding with the planned flash-to-subject distance in the Distance Scale, then set the F-number to the camera-lens.

- 3) Rotating the shutter speed dial, set the camera to the correct exposure for the brightness of entire background.

\* Set the shutter speed dial to click-stop positions. For fine exposure adjustment, slightly turn the aperture dial or change the subject distance by moving to or away from the subject.



- \* With the OM-2, 1/60 sec. or slower. (See page 24.)

\* Brightness balance between natural light and flash light may vary depending on your desired effects. Adjust the amount of light accordingly.



# OM-1

FOR USE WITH OM-1(& OTHER CAMERAS)

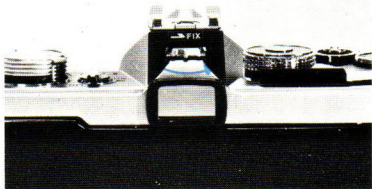

**1. Attach the Accessory Shoe 1 to the OM-1.**

\* The Accessory Shoe 2 cannot be mounted on the OM-1.

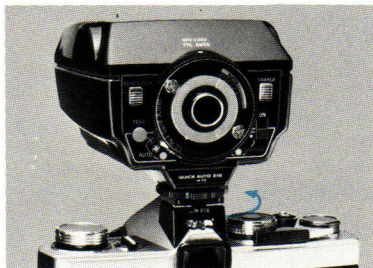

**2. Mount the Quick Auto 310 on the accessory shoe.**

Slide the Quick Auto 310 into the accessory shoe as far as it will go, and tighten the Lock Knob in the direction of the arrow ("FIX").

\* Use a coin or similar item to tighten the Lock Knob firmly.

\* On cameras with a hot shoe, the synch circuit is automatically completed when the flash unit is mounted.

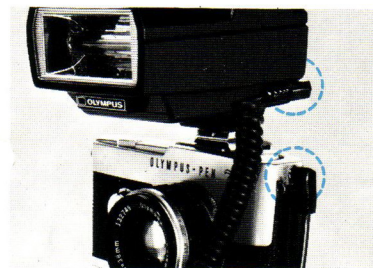

\* On cameras without a hot shoe:

- 1) Make certain the Power Switch is turned to OFF and plug the optional Synchro Cord into the Synchro Cord Socket of the Quick Auto 310, then mount it on the camera. (This will eliminate any possibility of accidental flashing due to short circuit across the Accessory-Shoe Mount and accessory shoe.)
- 2) Plug the other tip of the Synchro Cord into the camera's synchronization socket.

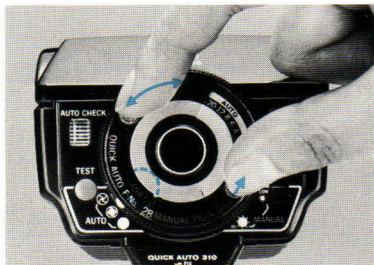

### 1. Set the ASA film speed.

Rotate the Switch Dial until the proper ASA rating for the film being used appears in the ASA Window.

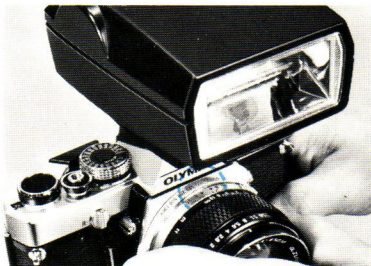

### 2. Set the camera's shutter speed dial

- 1) Focal-plane shutter camera  
Set the shutter speed for synchronization as per the manual for your camera. With the OM-1, 1/60 sec. or slower.
- 2) Lens-shutter camera  
The lens shutter camera synchronizes the electronic flash at all shutter speeds.  
See the manual for your camera for details.



### 3. Set the camera's synchronization terminal to "X".

With the OM-1, set the X and FP Selector to "X".



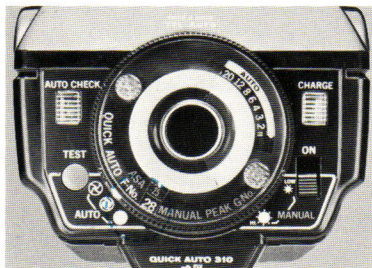

#### 4. Set NORMAL AUTO F-number on the Quick Auto 310.

Set the Switch Dial Index (white arrow) to one of the three AUTO Aperture Settings ( ● ⊕ ⊕ ) depending on the desired effects. The F-number corresponding to the symbol will appear in the NORMAL AUTO F-stop/MANUAL GN Window.

\* Be sure the Switch Dial is set at one of the click-stops.

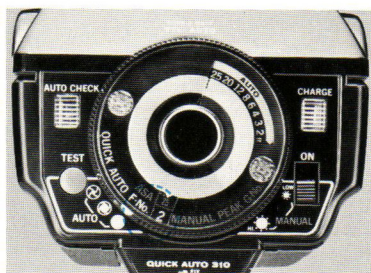

- 1) The largest aperture ● (F2 in case of ASA 25) when you want:
  - a. A small amount of light output.
  - b. To reduce glare on your subject.
  - c. Shallow depth of field.
  - d. Greater auto working distance.
  - e. To shorten recycling time.
  - f. To stop high-speed movements.
  - g. To prolong battery life.
  - h. To open lens aperture in daylight fill-in.

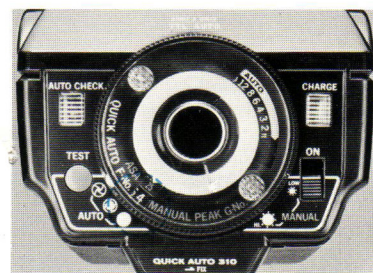

- 2) The smallest aperture ⊕ (F4 in case of ASA 25) when you want:
  - a. A large amount of light output.
  - b. Strong contrast.
  - c. Greater depth of field.
  - d. To make the flash unit as a main light source.
  - e. To zero-in on backlighting by closing lens aperture in daylight fill-in.
  - f. To minimize the effect of reciprocity failure, and when too much light at close distance.
- 3) The in-between aperture ⊕ (F2.8 in case of ASA 25) when you want the effects between ● and ⊕. This setting will be used most often for average flash shots.

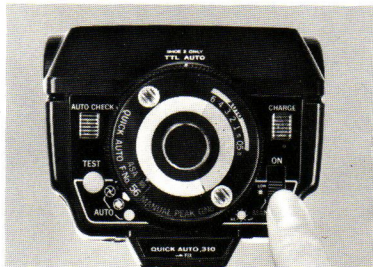

**5. Turn the Power Switch to ON.**  
Wait for the Ready/Charge Lamp to glow.

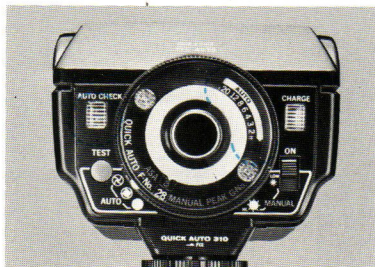

**6. Check whether the subject is in the NORMAL AUTO range.**

- 1) From the planned shooting position, aim the flash at the subject and push the Test Button. If the AUTO Check Lamp flickers, the subject is within the NORMAL AUTO flash operating range.
- 2) In the Distance Scale at the top right of the Switch Dial you can see the Operating range that corresponds with the F-number you selected.
- 3) If the subject is beyond the NORMAL AUTO operating range, set the AUTO Aperture Setting at a larger f-stop setting.

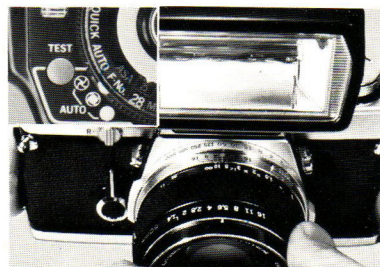

**7. Set the aperture control of the camera-lens.**

Set the aperture control to the F-number that appears in the NORMAL AUTO F-stop/MANUAL GN Window.





**8. Release the shutter.**

When the Quick Auto 310 is used with a 24-mm super wide-angle lens, marginal light falloff on the picture may sometimes be caused due to the difference between the area viewed by the lens and the area lit by the flash. Particularly at close distances shorter than 5 ft. or when taking a subject of an overall flat surface, e.g., a white wall, shading around the upper or bottom edge of the picture is likely to occur. Care should be exercised to overcome the parallax by using the Bounce Grip, etc.

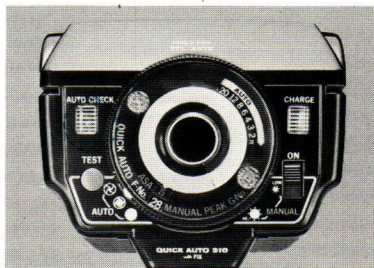

**9. Check to see if correct exposure is made.**

When the correct exposure is made, the AUTO Check Lamp flickers.

\* The flickering of the AUTO Check Lamp, even when the Ready/Charge Lamp is not lit as in consecutive flashing, also indicates that correct exposure has been made.

\* A flash-to-subject distance of less than 20" (ASA 100) is outside the NORMAL AUTO operating range. The flickering of the AUTO Check Lamp in such a case does not indicate that the correct exposure has been made.

\* To confirm whether correct exposure is made, conduct either Procedure 6 (before shooting) or 9 (after shooting) above.

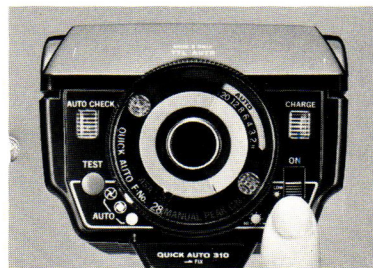

**10. Turn the Power Switch to Off.**

Turn off the Power Switch when you have finished or during extended periods between pictures.

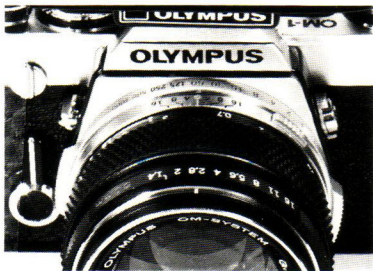

### 1. Intentional over- or under-exposure

Open or close the lens aperture off the F-number set on the Switch Dial. Adjust the f-stop according to your photographic purpose.



### 2. Portrait with night sky in the background

When the subject is not in the central part of the finder and surrounded with dark background such as night sky, or when the background is so far away to take pictures with the flash light, over-exposure may result.

In such a situation like this, close down the lens aperture one stop or two off the F-number set with the Switch Dial.



### 3. Portrait with white walls at back

Generally, when a white back such as white walls occupies the greater part of the picture or when a large white table is in front of the subject, the Sensor tends to see the intense reflected light from it. In a situation like this, open the lens aperture one stop or two off the F-number set with the Switch Dial.



### 1. Bounce Flash

The bounce flash technique produces realistic, subdued lighting effects. Using the optional Bounce Grip and Remote Sensor mounted on your camera, bounce flash can be easily performed at all bounce angles and distances. Simply aim your Quick Auto 310 at a convenient ceiling or wall to illuminate your subject with an even glow of reflected light. The Remote Sensor will point with your camera at the subject, keeping its "eye" on the exposure. For detailed operating instructions, see the leaflet packaged with the Remote Sensor.



### 2. Diffuse flash

Diffuse flash light is used to soften illumination when you want to use a large aperture at close range or when shooting with a wide-angle lens with a focal length less than 24mm. Cover the Quick Auto 310 Flash Lens with tracing paper or white cloth taking care not to cover the Sensor if a Remote Sensor is not being used. The monitor circuit computes correct exposure automatically compensating for the reduction in light reaching the subject because of the diffusion material.

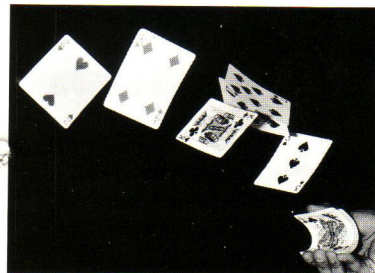

### 3. Ultra high-speed flash photography

In this technique, a short flash duration is used to stop high-speed motions. The auto electronic flash is designed to further cut off the already short flash duration to achieve proper exposures. In close-up, a duration of a fraction of  $1/10,000$  sec. is available to freeze objects moving with ultra high-speed, such as the flying bees and milk crown. Move close enough to the subject.





#### 4. Daylight fill-in Flash

NORMAL AUTO daylight fill-in is possible, but limited to a great extent by brightness and subject conditions. This method is practical when the main subject, e.g., a model, occupies most part of the central area in the focusing screen.

- 1) Determine f-stop and set it on the Switch Dial. (See page 22.)
- 2) Set the aperture control of the camera-lens to the F-number set on the Switch Dial. (See page 23.)
- 3) Set the camera to the correct exposure by rotating the shutter speed control. (See page 21.)

\* Affected by the ambient light, the balance of flashing will vary. Depending on your own particular photographic situations, bracket exposures.

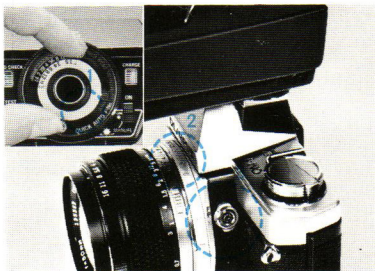

#### 1. Set the ASA film speed.

(See page 21)

#### 2. Set the camera's shutter speed control.

(See page 21.)

#### 3. Set the camera's synchronization terminal to "X".

(See page 21.)

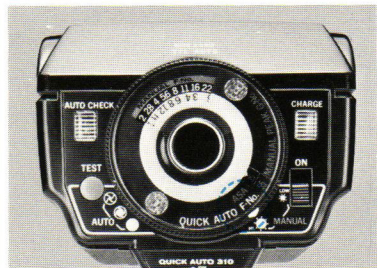

#### 4. Make the manual power setting.

Set the Switch Dial Index (white arrow) to the HI or LOW power setting depending upon the desired effects.

\* Be sure the dial is set at one of the click-stops.

HI: Full power flash at GN55  
(ASA 25, ft, at peak)

LOW: 1/4 light amount at GN27  
(ASA 25, ft, at peak)

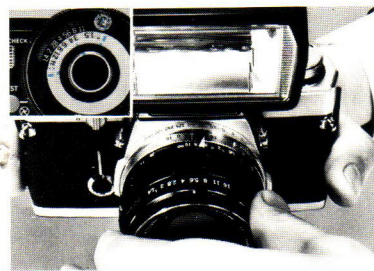
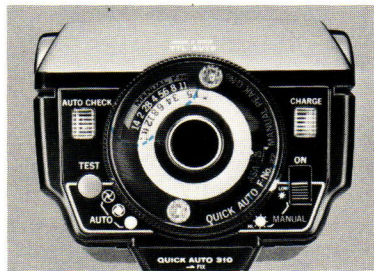
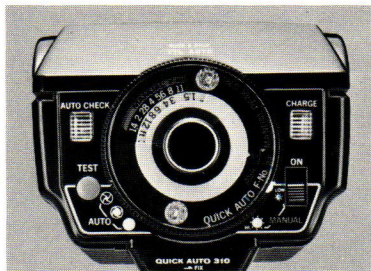

- 1) HI power setting ☀ (GN 55 at peak in case of ASA 25 in feet) when you want:
  - a. **A large amount of light output.**
  - b. Greater flash-to-subject distance.
  - c. More light than at the LOW setting.
  - d. Greater depth of field by closing lens aperture.
  - e. To zero-in on backlighting by closing lens aperture in daylight fill-in.

- 2) LOW power setting \* (GN 27 at peak in case of ASA 25 in feet) when you want:
  - a. **A small amount of light output.**
  - b. To take pictures at a close flash-to-subject distance.
  - c. To reduce glare on your subject.
  - d. To shorten recycling time.
  - e. To increase number of flashes per set of batteries.
  - f. Less depth of field by opening lens aperture.
  - g. To zero-in on backlighting by opening lens aperture in daylight fill-in, and

when lens aperture cannot be sufficiently stopped down at HI setting.

5. **Set the camera-lens' F-number.**

Set the aperture control of the camera-lens to the F-number that corresponds with the planned flash-to-subject distance shown in the Distance Scale at the top left of the Switch Dial.

The values on the calculator dial provide for a safety margin to compensate for possible battery fall-off, etc.



**6. Turn the Power Switch to ON.**  
Wait for the Ready/Charge Lamp to glow.

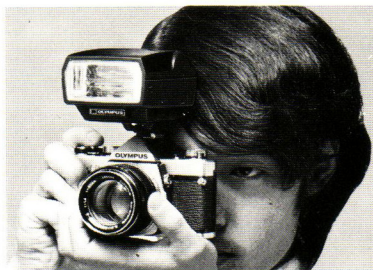

**7. Release the shutter.**  
At the "LOW" setting in the manual operation, the Auto Check Lamp will flicker as the auto circuit is used in conjunction with this setting; however, this is irrelevant to flash checking procedure.

You would often want to lighten a subject in shadows – in back light, under a tree, or indoors with part of the outdoor scene in the background – giving detail in the shadows as well as in the surrounding highlights.

In such situations, the TTL AUTO and NORMAL AUTO operations are possible, but may be affected to a considerable extent by the ambient light and subject conditions; therefore, MANUAL operation is recommended. See "High-technique MANUAL Flash with OM-2," page 18.



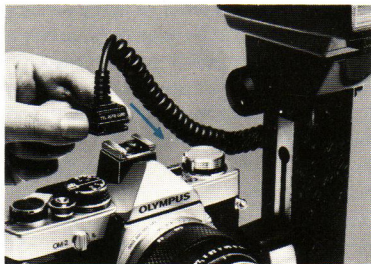

The TTL Auto Cord 0.6m becomes necessary when the Quick Auto 310 is separated from the OM-2 to conduct off-camera TTL AUTO flash, or bounce TTL AUTO flash in conjunction with the Bounce Grip. (The Accessory Shoe 2 must be attached to the OM-2 in advance.)

1. Slide the Auto Cord's Camera-Plug into the Accessory Shoe 2 as far as it will go, after making sure which end is the front.

\* The Camera-plug cannot be inserted in reverse.

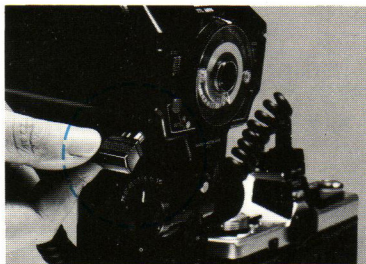

2. Insert the Auto Cord's Flash-Plug into the synchro cord socket of the Quick Auto 310.

**CAUTION**

- Should any one of the OM-2, Accessory Shoe 2 and Quick Auto 310 is replaced with other unit, TTL AUTO flash operation is not available: instead, the flash light is emitted on full output.
- Inserting the Flash-Plug into the synchro cord socket automatically sets the Quick Auto 310 to the TTL AUTO mode, even when the Switch Dial Index is not aligned to the "TTL AUTO" mark.
- When the Bounce Grip is used in conjunction with the TTL Auto Cord 0.6m, the built-in sync cord of the bracket unit should be placed back into its storage groove. If the built-in synch cord is plugged into the camera's synchronization socket, the Quick Auto 310 will not function.

- 1) As the color temperature of the Quick Auto 310 is similar to that of the sunlight, use daylight color films.
- 2) Do not leave the unit in a temperature area above 122°F (50°C).
- 3) At temperatures under 32°F (0°C), the circuits and batteries will not function normally. Warm them before use.
- 4) When the flash is not to be used for an extended period of time, remove the batteries to prevent battery leakage.
- 5) With the Switch Dial set to "TTL AUTO", accidental flashings may sometimes occur when the fully charged Quick Auto 310 is attached to or detached from the camera.
- 6) Do not hit the flash unit or let it strike any hard object.

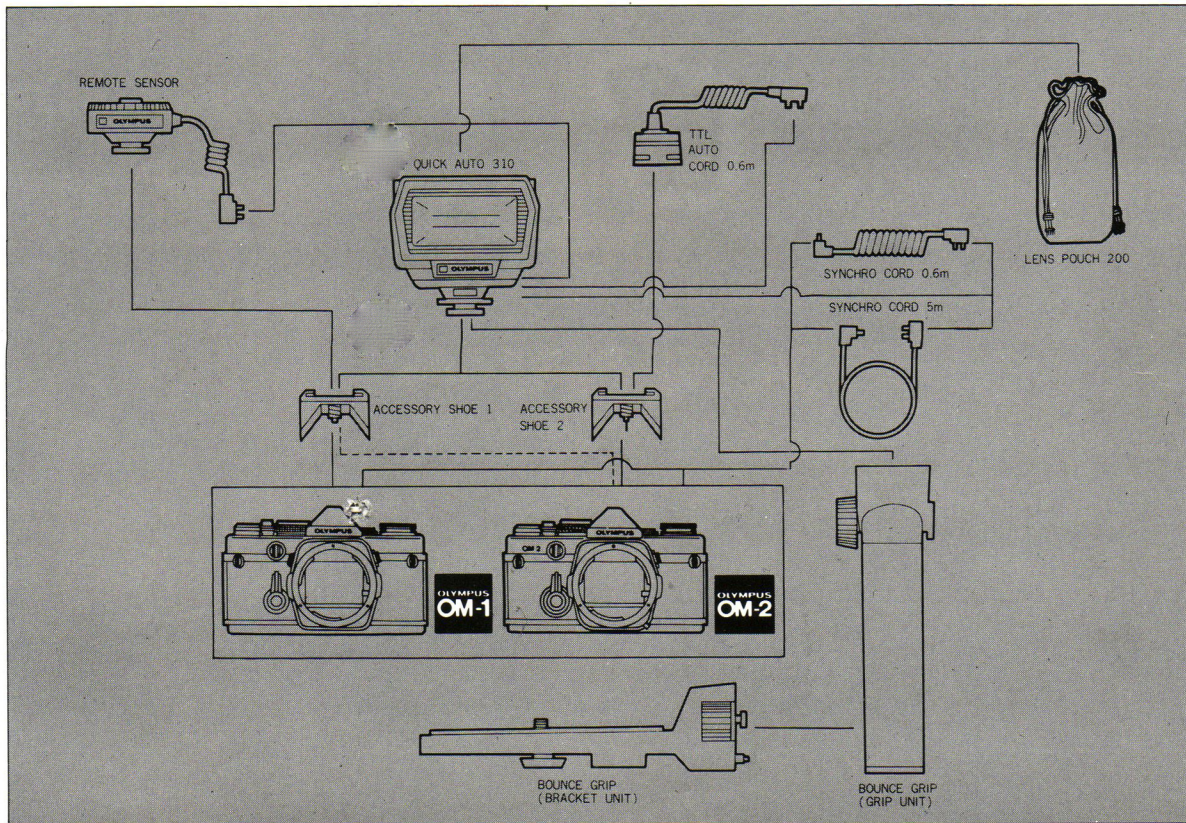





# OLYMPUS

**OLYMPUS OPTICAL CO., LTD.**

43-2 Hatagaya 2-chome, Shibuya-ku, Tokyo, Japan Tel. 03-377-2111

**OLYMPUS CAMERA CORPORATION**

145 Crossways Park, West, Woodbury, New York 11797, U.S.A. Tel. 516-364-3000

**OLYMPUS OPTICAL CO. (EUROPA) GMBH**

2 Hamburg 1, Steindamm, 105, West Germany Tel. 040-248021

**OLYMPUS OPTICAL CO. (U.K.) LTD.**

2-8 Honduras Street, London EC1Y 0TX, England Tel. 01-253 2772