

WILSONWERKS ARCHIVES

This camera manual is for reference and historical purposes, all rights reserved.

This cover page is copyrighted material. This document may not be sold or distributed without the express consent of the publisher.

©2008-2025 wilsonwerks Llc

PENTAX[®]

A3000



Thank you very much for choosing one of the world's most popular Pentax 35mm SLR's.

As you may already know, this programmed camera offers you three auto exposure modes, auto film-speed setting, auto film winding, etc., which are the most desired features by the photographer. Before you start to operate the camera, be sure to read this operating manual very carefully and familiarize yourself with every detail of this camera's features and functions so that you can fully enjoy the long-lasting, reliable service it ought to offer.

When using this booklet, it is a good idea to read the inside pages with the front and back flaps unfolded for easy reference to the camera's working parts.



WORKING PARTS NOMENCLATURE



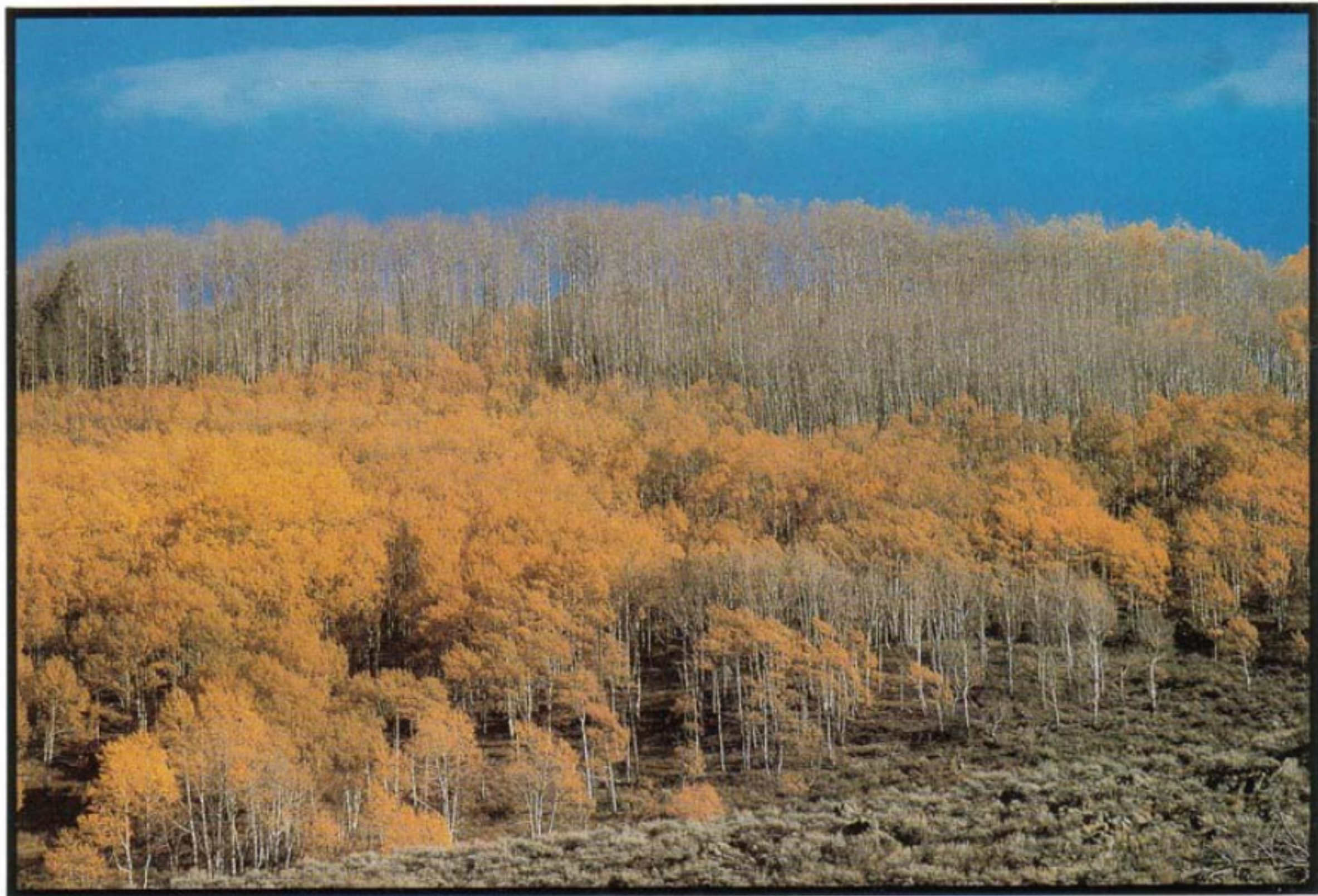

"GOLDEN ASPEN" by K. Chiwata, Pentax Corporation

TABLE OF CONTENTS

Features	2	ADVANCED OPERATIONS	
PREPARATIONS		Exposure compensation	30
Loading batteries; battery check	5	Using self-timer	31
Attaching and detaching lens	6	Using 60 $\frac{1}{2}$ (1/60 sec.)	32
Mode selector, shutter button, shutter button lock	7	Using B (bulb)	33
Setting ISO film speed	9	Depth of field	34
Loading film	10	Infrared index mark	37
Rewinding film	13	Programmed AE diagram, metering range and shutter/aperture coupling range	38
BASIC OPERATIONS		Attaching strap; soft case	40
Viewfinder displays	16	Diopter correction	41
Focusing	18	Mount adapter K	41
Holding camera	18	Precautions on accessories	42
"A" lens; mode selector	20	Precautions on batteries	43
Warning indications in viewfinder	21	Specifications	44
Using Programmed AE mode	22	Taking care of your camera	46
Using Aperture-priority AE mode	24	Warranty policy	48
Using Pentax dedicated auto flash units	26		
Using Programmed Auto Flash mode	27		

FEATURES

When an SMC Pentax-A lens is used with this camera, you can use all the three exposure modes: Programmed AE, Aperture-priority AE and Programmed Auto Flash. When the conventional K- or Kf-mount lens is used, you can use this camera in the Aperture-priority and conventional Auto Flash modes.



Programmed AE Mode

The camera automatically selects the most appropriate combination of shutter speed and aperture to obtain correct exposure, simultaneously changing them according to the brightness of the subject. This mode is most suitable for those who do not want to be bothered by setting exposure controls or those wanting to take "action" pictures (Refer to pp. 22/23 for details.)

Aperture-priority AE Mode

When you set the aperture manually, the shutter speed is automatically adjusted according to the brightness of the subject to provide correct exposure. Use this mode for ordinary picture-taking or portraiture, or when depth of field is important for your picture (Refer to pp. 24/25).

Programmed Auto Flash Mode

When you use a Pentax dedicated Auto Flash Unit with this camera in the Programmed AE mode, the camera automatically selects the proper aperture and shutter speed to control flash output (Refer to p. 27).

The questions and answers on what you should know first about this camera

Q.: I have depressed the shutter button but why has the shutter not been released?

A.: This camera doesn't operate if the batteries are not loaded properly. Check how they are loaded before operating. (For details, refer to P. 5.)

Q.: What kind of batteries should I use?

A.: Use two AA-size Alkaline batteries. No other kinds can be used. (Refer to p. 5.)

Q.: How many rolls of film can I shoot with this camera?

A.: About 50 rolls of 36-exposure film with a set of fresh batteries.

Q.: Can I use an electronic flash with this camera?

A.: You can use all the Pentax dedicated flash units. But, with the flash unit featuring TTL Auto Flash operation, you cannot use the TTL Auto Flash mode. (Refer to pp. 26/27/28.)

Q.: How can I take better pictures?

A.: Focusing is very important. Focus as accurately as possible, using the split-image or microprism in the viewfinder. Also, use a shutter speed faster than 1/60 sec. to prevent camera shake that causes blurred pictures, and always take the picture with the camera held firmly. (Refer to pp. 18/19.)

PREPARATIONS

LOADING BATTERIES

This camera needs two penlight (AA-size, 1.5-V) Alkaline batteries of the same brand to function properly. Manganese batteries are not recommended as their life is shorter. Do not use Ni-Cd batteries.

Because the battery discharges a small amount of energy even when not in use, those supplied with your camera may be slightly below full capacity as it has taken some time to reach you.

- Open the battery-chamber cover by sliding it in the direction of the arrow; use a finger-nail in the groove to push and raise the cover.
- Insert two batteries into the chamber so that their (+) and (-) marks face those indicated on the back of the cover. Close the cover by pushing it back.

Battery check

As illustrated, turn the mode selector to BATT. C. so that the white dot is aligned with the red-line index. If the battery check lamp glows, the batteries are properly loaded; if not, they are incorrectly loaded or the battery power is insufficient. When the film advancing time gets apparently slower, it indicates that the batteries are getting weaker. Replace the batteries with fresh ones.

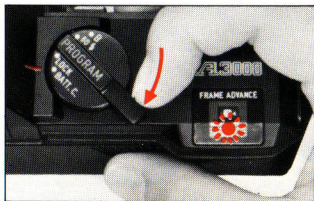
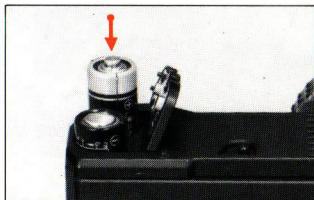
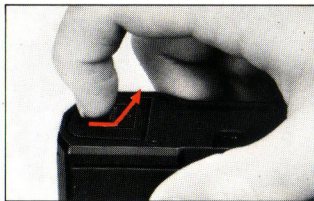

ATTACHING AND DETACHING LENS

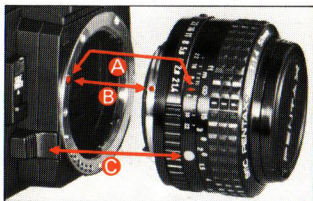

To mount or interchange Pentax K, KA and Kf mount lenses follow the steps below.

- Remove the body mount cap and the rear lens cap. If the finder cap is still on the eyepiece, remove it.
- Align the red dot on the camera body with the red dot on the lens (See A, B). Seat the lens in the body mount and turn it clockwise until the lens locks with a click. When mounting the lens in dim light, method (C) is recommended. This method allows lens mounting by touch.
- Align the raised node on lens barrel with the lens release by touch. Then turn and lock as above.
- To remove the lens cap, press in on the notches at both sides.
- To remove the lens, press the lens release lever toward the camera body while turning the lens counter-clockwise.
- After removing a lens from the camera body, replace the front and rear lens caps to protect the lens from dust and stains.



Note: Don't damage or stain the electrical contact points on the mount face. When they become stained, wipe them with a clean, dry cloth.

MODE SELECTOR, SHUTTER BUTTON, SHUTTER BUTTON LOCK

Mode Selector

Turn the mode selector by using the lever and set the dial to your desired mode.

B: Bulb (Long-time exposure)

60: 1/60 sec. (Flash-sync speed)

PROGRAM: Programmed AE mode (Lens locked at "A")
Aperture-priority AE mode: (Lens set at any f-stop)

LOCK: Shutter button is locked.

BATT. C.: Battery Check

Shutter Button

As you set the mode selector to "PROGRAM" and partially depress the shutter button, the exposure meter will be switched on and depressing the button further will release the shutter. If you take your finger from the shutter button, the meter will be automatically switched off.

Shutter Button Lock

If you turn the mode selector to "LOCK," the shutter button is locked so that the shutter cannot be released. Use this device when the camera is not in use for some time.

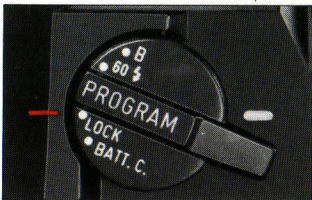
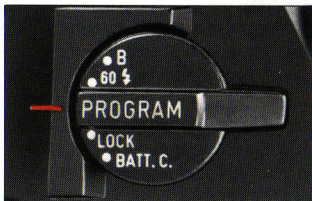

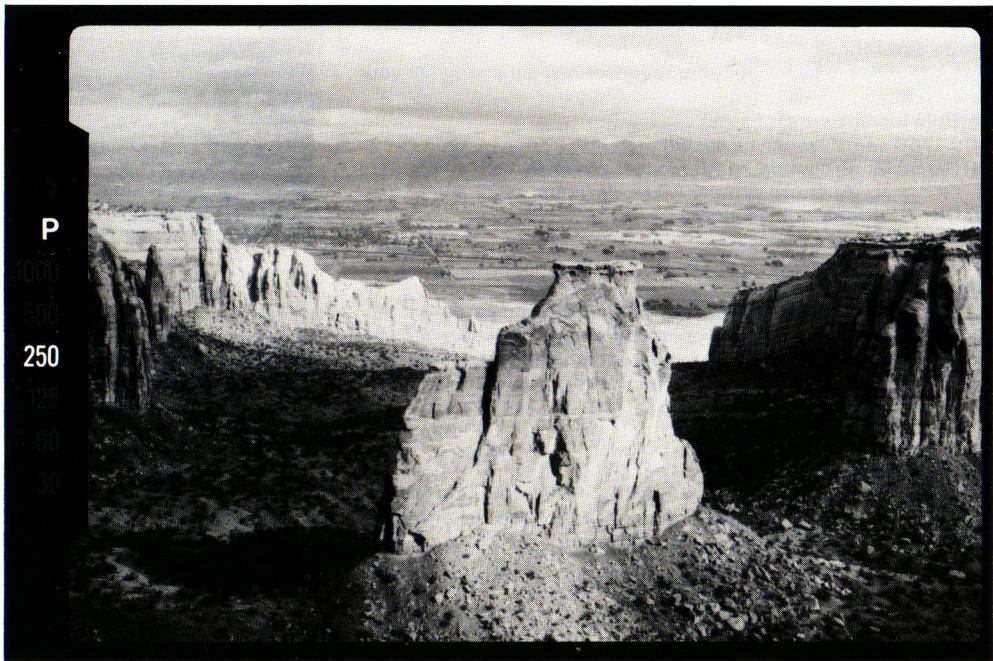

P

250

SETTING ISO FILM SPEED

NON-DX FILM

It is very important to set the ISO dial to the film speed indicated on the film package to obtain correct exposure. While depressing the ISO dial lock release, turn the ISO dial until the ISO number of your film is aligned with the red-line index. Make sure that the dial is locked in position, by releasing the lock release and slightly rotating the dial from side to side. The usable ISO range of the ordinary film with this camera is from 25 ~ 1600.

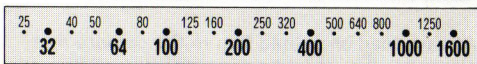
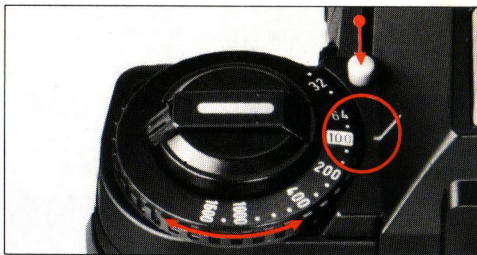

DX FILM

When this camera is loaded with DX film, its ISO film speed is automatically set by the camera, no matter what setting appears on the ISO dial. When using DX film, make sure that the film does have a DX mark or the cassette has a DX information panel, since there are also non-DX films available, of the same type. The usable film speed of the DX film with this camera ranges from ISO 25 ~ 1600.

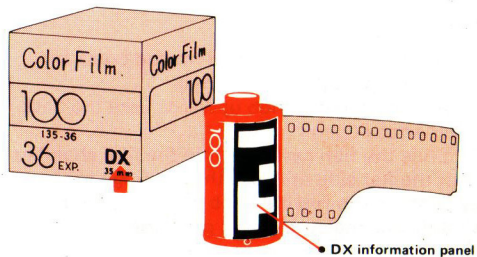

LOADING FILM

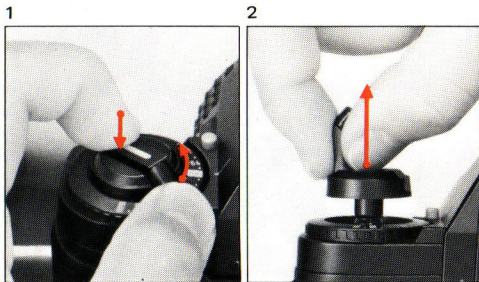

Always load or unload film in the camera in a shady spot, or shield it from direct sunlight with your body.

1. As illustrated, unfold the rewind crank by pushing it with your finger-nail.
2. Pull the rewind knob upwards until the back cover snaps open.
3. Slide the film cartridge into the film chamber with the flat side up. Lock the cartridge in place by pushing the rewind knob down, rotating it slightly making sure that it grips the spool.

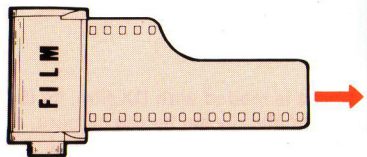
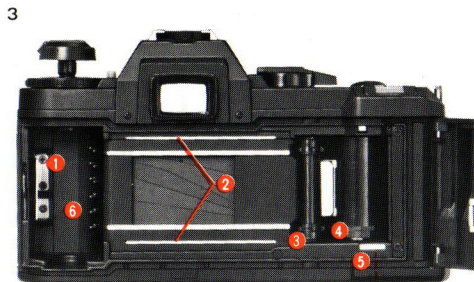

- | | |
|------------------|------------------------|
| 1 Film chamber | 4 Spool teeth |
| 2 Guide rails | 5 Film leader end mark |
| 3 Sprocket teeth | 6 DX-information pins |

Keep the DX-information pins free from scratches, dirt, dust, etc.

4. As illustrated, pull the film leader out so that its end aligns with the 5 film leader end mark (red bar); in other words, bring the film leader end within the length of the bar.

- Make sure that the perforations on the bottom side of the film have engaged the 3 sprocket teeth as well as the 4 spool teeth.
- Also make sure that the film is properly placed between the two 2 guide rails.
- Take up any slack left in the film so that the film is flat as shown, by rewinding it slightly into the cartridge.
- When a film with a higher ISO number is loaded, do not leave the camera out of the case for a long time.

4

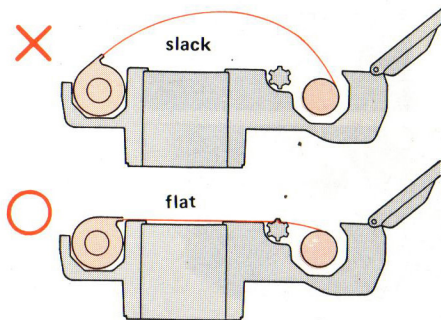
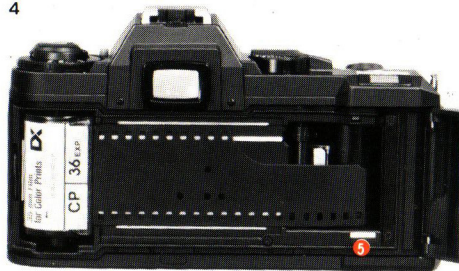



5. Close the back cover, making sure that it snaps firmly into place. As you depress the shutter button, the camera will automatically continue releasing the shutter and advancing the film until "1" appears on the frame counter. Whilst this is taking place, the film advance lamp is on. (In whatever position the mode selector is, the shutter in this case will be released at 1/1000 sec., making blank exposures until "1" appears on the frame counter.)



6. If the rewind knob turns in the direction of the arrow while the film is being transported, it indicates that the film is advancing properly.



7. When the frame counter is set to "1," you are now ready to start shooting. The film-loaded indicator on the back cover helps you check if the film is loaded or not.

REWINDING FILM

When the last frame of the roll is exposed, the motor will automatically stop. Now, do not open the back cover, but rewind the film into the cartridge immediately in the following ways:

- Depress the film rewind button. If the button does not stay depressed, keep it depressed until the next step is finished.
- Unfold the rewind crank, and turn it in the direction of the arrow, until the exposure counter returns to "1" or you simultaneously feel no pressure on the rewind crank.
- When the rewind crank feels loose, it indicates that the film leader has been released from the take-up spool. Pull the rewind knob upwards to make the back cover snap open. Remove the cartridge from the chamber.

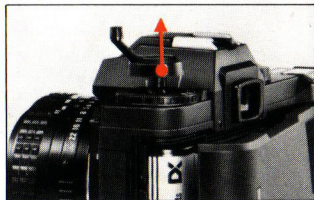
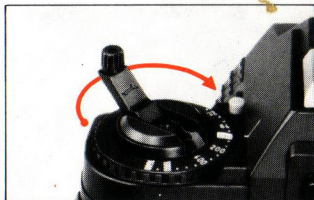
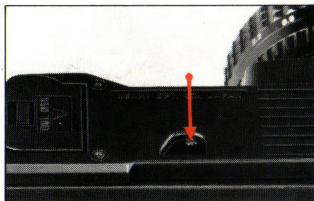



BASIC OPERATIONS

VIEWFINDER DISPLAYS

Visible on the left-hand side of the viewfinder are shutter-speed LED's, exposure information in the Programmed AE and Aperture-priority AE modes, flash information, slow-shutter-speed warning, out-of-shutter/aperture-coupling-range indication, error in mode/aperture combination, etc.

- LED = Light Emitting Diode

P Programmed AE mode

1000~30 Shutter speed information.
1000 stands for 1/1000 sec.;
30 stands for 1/30 sec. Shutter speeds are displayed in full stop increments. (1000~60 in green; 30 in yellow)

Flickering 1000 Overexposure (Flickers eight times per second)

Flickering 30 Underexposure (Flickers eight times per second); slow-shutter-speed warning (Flickers two times per second)

- Over- and underexposure displays also indicate exposure combinations beyond the shutter/aperture coupling range or beyond the metering range.
- The flickering "1000" is accompanied by a beeping sound.

Flickering ♪ indicates the completion of flash charging and the auto-flash exposure confirmation with a dedicated flash.

Flickering "P" indicates the combination of mode selector dial and aperture is not appropriate.

⚡
P
1000
500
250
125
60
30

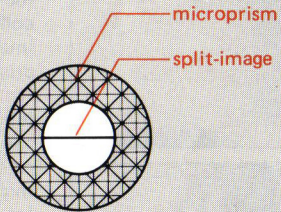

matte field

FOCUSING

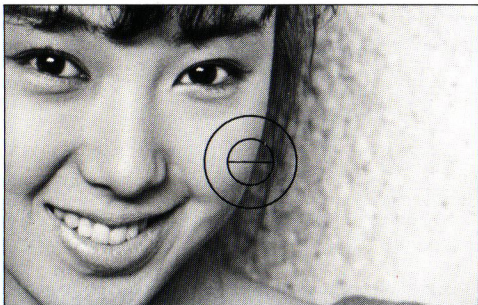

You can focus in three ways, with the split-image, microprism, and/or matte field. To focus using the split-image, turn the focusing ring until the two images in the split-image circle at the center of the focusing screen are perfectly aligned. When using the microprism collar, focus until the glitter disappears from inside the collar. With the matte field, focus until the image on the matte field appears sharp and crisp.

Note: If the maximum aperture of the attached lens is smaller than $f/5.6$ (for example, $f/8$ as in the case of a long telephoto), it is easier to focus on the matte field since the split-image and microprism collar areas become much too dark for satisfactory focusing.

Diopter adjustment for viewfinder eyepiece

People who wear eyeglasses due to myopia, hypermetropia or presbyopia, sometimes find it difficult to focus while wearing their glasses. In this case, use the accessory diopter correction lenses M (See page 41).

HOLDING CAMERA

Proper holding of the camera is essential to minimize camera shake which causes blurred pictures. Practice holding and operating your camera before inserting your first film cartridge. Generally there are three basic ways to hold the camera. In any case, hold the camera tightly to your face with your hands. The grips on this camera will help you keep a steady hold on your camera. Release the shutter gently while slowly breathing out. Strong pressure on the shutter

release button may cause blurred photographs. Take a secure, well-balanced posture without straining yourself. The portion marked O in the illustration should be drawn to your body. It is a good idea to stabilize your body and the camera using a tree, building wall, table, etc. For long exposures or while using telephoto lenses, it is recommended to use a tripod and a cable release in order to reduce camera shake to a minimum.

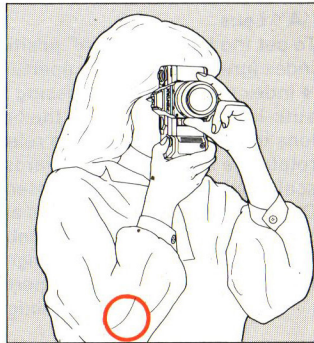
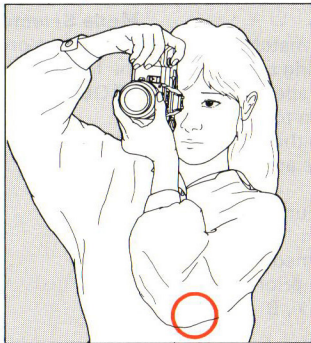
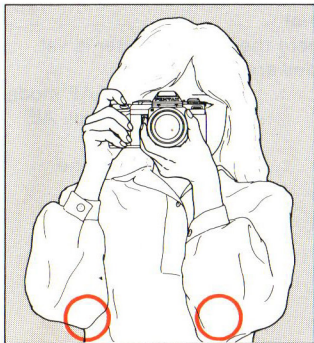

"A" LENS; MODE SELECTOR

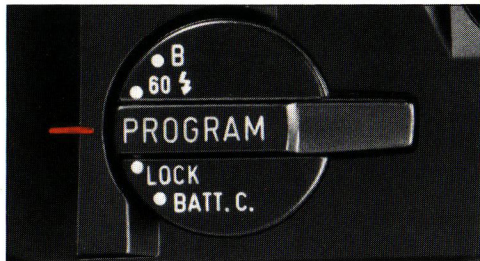
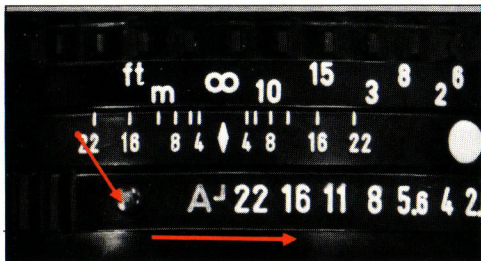

"A" Lens

To set the lens in the "A" position, match the A-index (green line) on the aperture ring to the ♦ index mark while depressing the aperture auto-lock button. Release the button to lock the lens in the "A" position. To release the lock, rotate the aperture ring towards the aperture scale with the button depressed.

Depending on where the lens aperture is set, the following modes are available:

- A (Auto) setting** Programmed AE mode
- f-number setting** Aperture-priority AE mode 60 ⚡ , B

Mode Selector Dial

Depending on where the mode selector is set, the following modes are available:

- PROGRAM** Programmed AE mode
- Aperture-priority AE mode
- 60 ⚡** Flash-sync speed
- B** Bulb

WARNING INDICATIONS IN VIEWFINDER

Shutter speed display	What it means
P 1000	This combination is beyond the meter coupling range in the Programmed AE mode. Results in incorrect exposure. "1000" or "30" flickers fast to warn you of the error.
P 30	
1000	Indicates the exposure combination is beyond the metering range, or shutter/aperture coupling range. When beyond the metering range, you can shoot by changing the f-stop. When beyond the shutter/aperture coupling range, the flickering will continue even if the f-stop is changed. Shooting with this warning on display will result in incorrect exposure. "1000" or "30" flickers at a fast speed.
30	
P 30	When the subject is dark, "30" flickers slowly, warning you against camera shake.
30	
P	When the lens is A-locked and the mode selector is set at "B" or "60," "P" flickers, warning you of the error

- Various warnings are indicated by the glowing of the LED's in the viewfinder, or by the beeping sound.
- The out-of-metering-range refers to the exposure situation in which the subject is too dark or too bright for the camera's meter to measure the light.
- The out-of-shutter/aperture-coupling-range refers to the situation in which the combination of shutter speed and aperture is beyond the limit of use even when it is within the metering range.
- Refer to page for Metering Range and

Shutter/Aperture Coupling Range.

- The  symbol in the table indicates flickering.

Out of metering range

When the viewfinder indicates this warning, you are recommended to take the following measures to obtain proper exposure:

- When the subject is too bright, use an ND filter which enables you to control the amount of light.
- When the subject is too dark, use a flash or some other lightings.

USING PROGRAMMED AE MODE

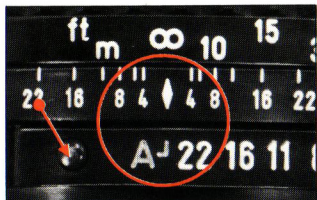

- While depressing the aperture auto-lock button on your SMC Pentax-A lens, rotate the aperture ring until the A-index (green line) click-stops at or aligns with the ♦ aperture/distance index mark.

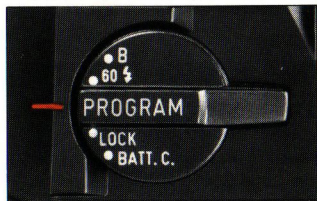

- Set the mode selector at "PROGRAM" by moving its lever.

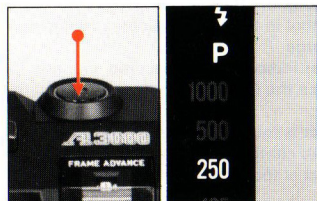

- Depress the shutter button partially, and "P" and a shutter speed will be shown in the viewfinder. Depress the shutter button all the way to release the shutter. The film will automatically advance to the next frame

■ If you remove your finger from the shutter button as soon as the shutter has been released, a single-frame exposure is made. Likewise, if you keep depressing the button, continuous shooting takes place.

• When the subject is too bright or too dark, the shutter speed "1000" or "30" in the viewfinder flickers and the PCV sound is also heard when the "1000" flickers, warning you of the problem. When the subject is too dark and "30" flickers, use a flash to obtain correct exposure. For details, refer to p. 21.

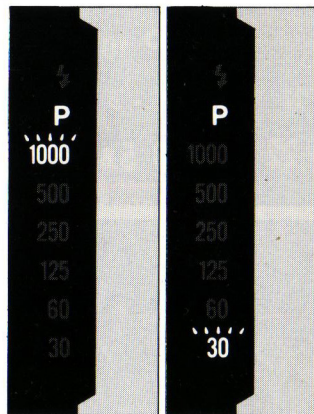

USING APERTURE-PRIORITY AE MODE

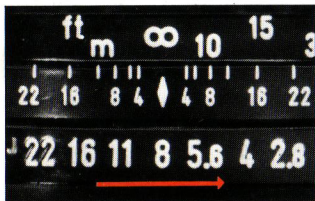

- First make sure that the lens is not locked at the "A" position. Turn the aperture ring to your desired f-stop.

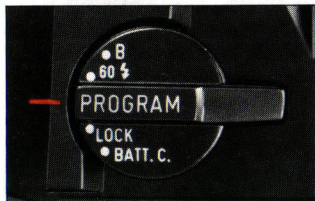

- Set the mode selector to PROGRAM.

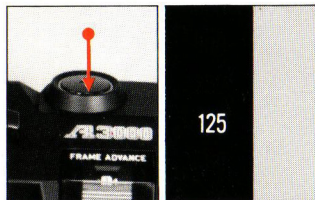

- Depress the shutter button half-way, and the shutter speed will be indicated in the viewfinder. As you depress the shutter button completely, the shutter will be released to take a picture.

- When the subject is too bright or too dark, the shutter speed “1000” or “30” in the viewfinder flickers and the PCV sound is also heard when the “1000” flickers, warning you of the problem. In this case, open the lens aperture to a larger f-stop or close it to a smaller f-stop, so that the flickering may disappear and you may obtain correct exposure. When the subject is too dark, use a flash to obtain correct exposure. Refer to p. 21 for detailed warning indication.

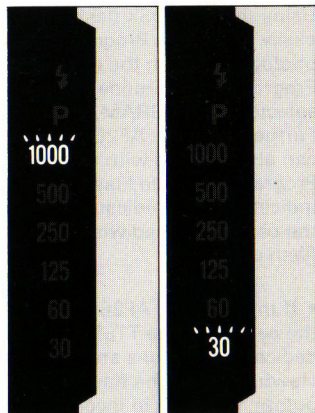

Using the AF200SA flash unit with this camera easily allows the Programmed Auto Flash photography with the camera set to the Programmed AE mode. Set the camera's mode selector to PROGRAM, and turn the flash to ON. Furthermore, the AF200T, AF280T and AF400T can also be used with this camera in the Programmed Auto Flash mode. The table indicates what dedicated functions work when the camera is used with Pentax dedicated auto flash units.

- If the AF200T, AF280T or AF400T is used with the camera in the TTL Auto Flash mode, the dedicated functions are indicated in the viewfinder, but the flash emits the full light output, resulting in incorrect exposure.
- The AF200SA does not provide the dedicated function described in 3.
- AF080C, AF200S, AF160 and earlier Pentax flashes apply to 1 and 2 only in the table, when the camera is used in the Aperture-priority AE mode.
- When the Pentax dedicated auto flash is used in its M or MS mode, the dedicated functions in the Programmed AE mode do not work.

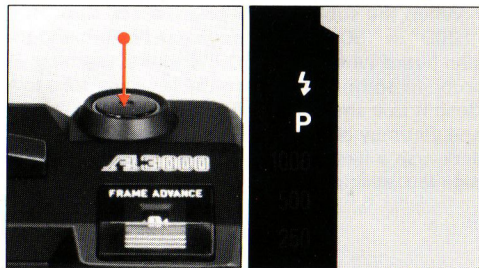

	Dedicated Functions (In Programmed Auto Flash mode)
1	Flash-ready indication by the lighting of ⚡ mark.
2	As soon as flash is ready, shutter speed is automatically set at X(1/60 sec.) for flash sync.
3	When flash has worked properly, ⚡ mark in viewfinder disappears for an instant and lights up again or flickers, indicating that proper flash sync has been made.
4	In Programmed AE mode, aperture is also set automatically.

USING PROGRAMMED AUTO FLASH MODE

When using any Pentax dedicated flash in the Programmed Auto Flash mode, you can set the camera in either Programmed AE or Aperture-priority AE mode.

- (1) Attach the flash to the camera.
- (2) Set the flash mode selector of your flash to AUTO (red, green, or yellow).
(This does not apply to AF200SA.)
- (3) Turn the flash switch on.



When set in Programmed AE mode

- AF200SA, AF200T, AF280T and AF400T are compatible.
- When the ⚡ mark and "P" appear in the viewfinder while you are keeping the shutter button depressed half-way, it indicates that the flash has been fully charged, and simultaneously the shutter is set to work at the sync speed of 1/60 sec. The aperture is also automatically set to the programmed f-stop as shown in the table, according to the AUTO position you choose.

(At ISO 100)

	AF200T	AF280T	AF400T
Red	f/2.8	f/4	f/4
Green	f/5.6	f/8	f/8
Yellow	—	—	f/11

(AF200SA: f/4 at ISO 100)

- As the film speed changes, the aperture also changes automatically.

When set in Aperture-priority AE mode

- Set the lens aperture to the f-stop indicated by the calculator on the flash.
- When the \downarrow mark appears in the viewfinder while you are keeping the shutter button depressed half-way, it indicates that the flash has been charged, and the shutter speed is automatically set to 1/60 sec.

Auto Flash Check mark (\downarrow)

When a proper flash photo has been taken, the \downarrow mark in the viewfinder disappears for an instant just after the flash firing and lights up again or flickers, indicating the completion of a proper flash photography. The AF200SA does not have this Auto Flash Check function.

- As shown in the table on page 27, when the camera is set to the Programmed AE mode and used with the AF200T in its red AUTO mode, the aperture is automatically set to f/2.8 with ISO 100 film. In such a case, avoid using a lens with the smaller aperture such as f/4; otherwise, underexposure may result.

ADVANCED OPERATIONS

EXPOSURE COMPENSATION

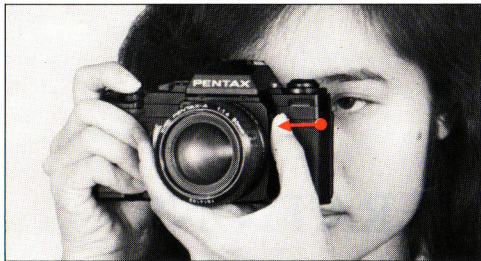

Shooting people who are back-lighted or with a clear, blue sky, or snow in the background will inevitably result in underexposed pictures, in other words, the people will look very dark. In such a case, depress the shutter button while depressing the exposure compensation button as well, and you will get correct exposure.

Uncompensated



Compensated



USING SELF-TIMER

The self-timer is handy for a group photo including yourself. To set the self-timer, first slide the self-timer lever up as indicated. Then, depress the shutter button, and the self-timer LED will start flickering, accompanied by a beeping sound. About 12 seconds later, the shutter will be released automatically. About two seconds before shutter release, the self-timer will start to flicker and beep at a faster rate. If you want to interrupt the self-timer operation once it has started, return the self-timer lever to the original position.

Caution: When "P" in the viewfinder flickers with the shutter button depressed half-way, or when the mode selector is set at B, the self-timer cannot be used. When taking a picture with your eye removed from the viewfinder eyepiece, the light coming through the eyepiece may affect the exposure, resulting in underexposure. Therefore, when using the self-timer, it is advisable to attach the viewfinder cap to the accessory groove in the eyepiece frame.

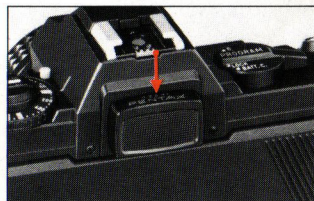
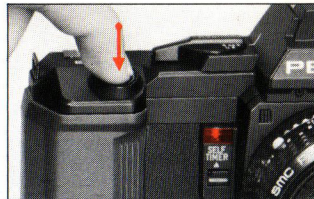

USING 60 $\frac{1}{60}$ SEC.)

When using a non-dedicated flash unit (having X contact only), set the mode selector dial at 60 $\frac{1}{60}$. This setting of 1/60 sec. can be used for ordinary picture-taking, but in that case, you cannot make sure of correct exposure through the viewfinder. As illustrated, align "60" on the dial with the red-line index.

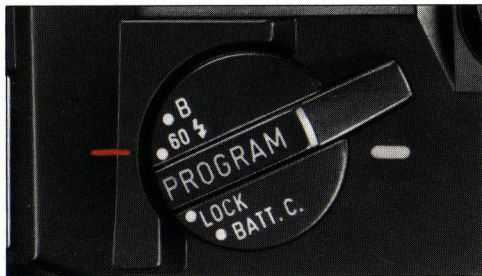

- When using a clip-on type flash, set the lens aperture to the appropriate f-stop according to the camera-to-subject distance or the program of the flash. (Refer to the instructions that accompany the flash unit.)
- Flash units using a sync cord cannot be used on this camera.
- When the lens is locked in A, the 60 $\frac{1}{60}$ setting cannot be used, nor can the shutter be released even with the shutter button depressed. With the Pentax dedicated flashes described on page 26, even when the lens is A-locked, the dedicated functions work, enabling you to take flash photos. If the flash is not fully charged, the shutter cannot be released.

USING B (BULB)

This setting is used to make long exposures of more than one second, required for taking pictures of fireworks, night scenes, astrophotography, etc.

- Set the mode selector dial as shown. As long as you keep depressing the shutter button, the shutter remains open. If the lens is A-locked, the B setting cannot be used, and the shutter cannot be released even if you depress the shutter button.
- When shooting on this B setting, mount the camera on a solid tripod, and also use an optional accessory: Cable Switch A or Cable Release, attaching it to the cable socket on the grip. If you also use the Pentax Cable Release 30 or 50, Time exposures can be made easily.

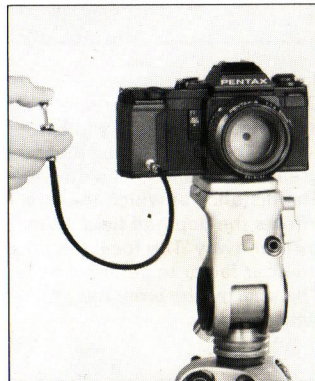

DEPTH OF FIELD

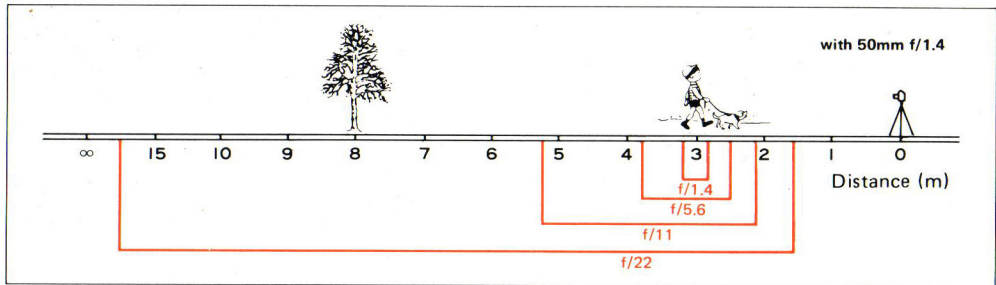

Depth of field is the area of acceptable sharpness in front of and behind the point of focus. The depth of field becomes progressively greater as the lens opening becomes smaller. The distance at which the lens is focused also affects the depth of field: it increases as you get further away. The focal length of the lens is another factor to determine the depth of field. The shorter the lens, the greater the depth of field.

To check the depth of field on your camera, you can use the depth-of-field scale in front of the aperture ring on the lens. First focus the camera, then move the aperture ring to the shooting aperture. Now check the f-numbers on the scale in front of the aperture ring. Notice the alignment in relation to the distance markings on the focusing-ring scale. Your depth of field is between the distances aligned with the proper pair of f-stop numbers.



f/1.4 (2.85 ~ 3.16m)

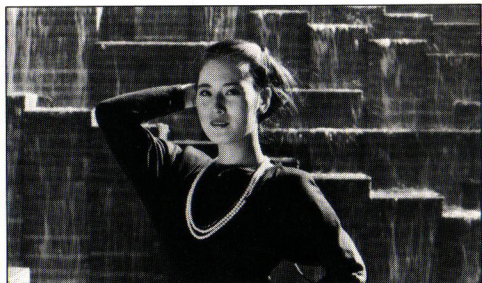

f/22 (1.67 ~ 16.88m)

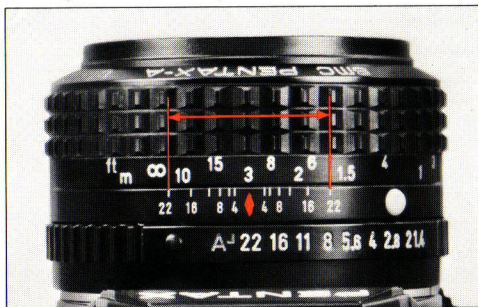

Depth-of-field Table: SMC Pentax-A 50mm Lens

unit=meter

Distance scale	f/1.4	f/2	f/2.8	f/4	f/5.6	f/8	f/11	f/16	f/22
0.45m	~ 0.448 0.453	~ 0.446 0.454	~ 0.445 0.455	~ 0.443 0.457	~ 0.440 0.460	~ 0.436 0.465	~ 0.431 0.471	~ 0.423 0.481	~ 0.414 0.493
0.5m	~ 0.497 0.503	~ 0.495 0.505	~ 0.494 0.507	~ 0.491 0.509	~ 0.487 0.513	~ 0.482 0.519	~ 0.476 0.527	~ 0.466 0.540	~ 0.454 0.557
0.6m	~ 0.595 0.605	~ 0.593 0.607	~ 0.590 0.610	~ 0.586 0.615	~ 0.581 0.621	~ 0.573 0.630	~ 0.564 0.642	~ 0.549 0.663	~ 0.532 0.691
0.8m	~ 0.791 0.810	~ 0.787 0.814	~ 0.781 0.820	~ 0.774 0.828	~ 0.764 0.840	~ 0.749 0.859	~ 0.732 0.883	~ 0.705 0.927	~ 0.675 0.987
1.0m	~ 0.985 1.016	~ 0.978 1.023	~ 0.970 1.032	~ 0.958 1.046	~ 0.942 1.066	~ 0.919 1.098	~ 0.892 1.140	~ 0.851 1.218	~ 0.806 1.328
1.5m	~ 1.464 1.538	~ 1.449 1.555	~ 1.430 1.578	~ 1.402 1.613	~ 1.366 1.664	~ 1.316 1.746	~ 1.259 1.861	~ 1.174 2.093	~ 1.086 2.462
2.0m	~ 1.935 2.070	~ 1.908 2.101	~ 1.874 2.144	~ 1.825 2.213	~ 1.764 2.312	~ 1.679 2.478	~ 1.584 2.724	~ 1.449 3.265	~ 1.314 4.298
3.0m	~ 2.853 3.164	~ 2.794 3.239	~ 2.719 3.346	~ 2.615 3.521	~ 2.487 3.785	~ 2.318 4.265	~ 2.137 5.073	~ 1.892 7.426	~ 1.665 16.883
10.0m	~ 8.488 12.171	~ 7.973 13.421	~ 7.375 15.552	~ 6.631 20.422	~ 5.846 35.101	~ 4.966 ∞	~ 4.181 ∞	~ 3.313 ∞	~ 2.655 ∞
∞	~ 55.370 ∞	~ 38.772 ∞	~ 27.707 ∞	~ 19.408 ∞	~ 13.876 ∞	~ 9.726 ∞	~ 7.086 ∞	~ 4.885 ∞	~ 3.565 ∞

unit=feet

1.55'	~ 1.541' 1.559'	~ 1.537' 1.563'	~ 1.532' 1.569'	~ 1.524' 1.577'	~ 1.514' 1.588'	~ 1.499' 1.605'	~ 1.481' 1.626'	~ 1.452' 1.664'	~ 1.419' 1.712'
1.8'	~ 1.787' 1.813'	~ 1.781' 1.819'	~ 1.774' 1.827'	~ 1.763' 1.839'	~ 1.749' 1.855'	~ 1.728' 1.879'	~ 1.703' 1.911'	~ 1.662' 1.966'	~ 1.616' 2.037'
2.2'	~ 2.179' 2.221'	~ 2.170' 2.230'	~ 2.159' 2.243'	~ 2.142' 2.262'	~ 2.119' 2.288'	~ 2.087' 2.327'	~ 2.047' 2.30'	~ 1.985' 2.472'	~ 1.916' 2.594'
3'	~ 2.959' 3.043'	~ 2.941' 3.061'	~ 2.919' 3.086'	~ 2.842' 3.125'	~ 2.842' 3.178'	~ 2.779' 3.261'	~ 2.705' 3.372'	~ 2.590' 3.576'	~ 2.465' 3.857'
4'	~ 3.924' 4.080'	~ 3.892' 4.115'	~ 3.850' 4.162'	~ 3.790' 4.236'	~ 3.712' 4.339'	~ 3.601' 4.504'	~ 3.472' 4.728'	~ 3.277' 5.159'	~ 3.071' 5.796'
6'	~ 5.823' 6.189'	~ 5.750' 6.274'	~ 5.655' 6.391'	~ 5.520' 6.574'	~ 5.349' 6.837'	~ 5.113' 7.274'	~ 4.846' 7.907'	~ 4.459' 9.256'	~ 4.072' 1.658'
8'	~ 7.681' 8.347'	~ 7.552' 8.505'	~ 7.387' 8.726'	~ 7.153' 9.080'	~ 6.863' 9.600'	~ 6.471' 10.504'	~ 6.041' 11.910'	~ 5.441' 15.352'	~ 4.864' 23.580'
15'	~ 13.888' 16.307'	~ 13.461' 16.941'	~ 12.932' 17.867'	~ 12.212' 19.464'	~ 11.369' 22.104'	~ 10.305' 27.766'	~ 9.228' 40.901'	~ 7.865' ~1(6.664)'	~ 6.687'
∞	~ 181.664' ∞	~ 127.208' ∞	~ 90.904' ∞	~ 63.676' ∞	~ 45.525' ∞	~ 31.911' ∞	~ 23.247' ∞	~ 16.028' ∞	~ 11.696' ∞

INFRARED INDEX MARK

If you intend to take infrared photographs using infrared film and R2 or O2 filters, it is necessary to compensate for the difference between visible light focus and infrared focus. As shown on the right, note the subject-to-camera distance on the lens distance scale as you focus through the viewfinder and turn the focusing ring until that distance setting aligns with the red infrared index mark. The figure shows an example in which the subject-to-camera distance is set at infinity (∞).

Automatic exposure is not workable in this type of special photography. The exposure must be controlled by the aperture ring, with the mode selector set to "60" (1/60).

For details on exposure control, refer to the instructions accompanying the film.



PROGRAMMED AE DIAGRAM, METERING RANGE AND SHUTTER/APERTURE COUPLING RANGE

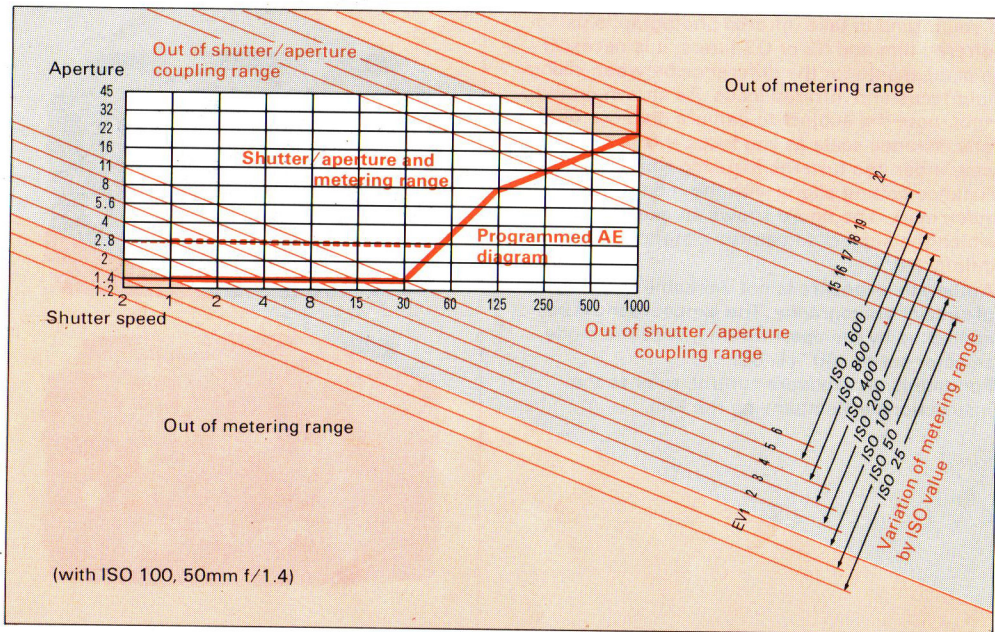

The shutter-speed and aperture combination in the Programmed AE mode is shown in the chart. The red line represents the variation of shutter-speed and aperture combination with an $f/1.4$ lens. Note that only the shutter-speed slows down after the lens aperture reaches its limit of $f/1.4$ in combination with a speed of approx. $1/30$ sec. When you use a lens with a different maximum aperture, the exposure program varies the aperture and the shutter-speed in combination until reaching the maximum aperture of your lens. For example, with an $f/2.8$ lens the program varies the combination as shown by the red dotted line. Note that only the shutter-speed changes after the maximum aperture is reached. The fine red line in the Programmed AE diagram indicates the Automatic Exposure control range for a lens with minimum aperture smaller than $f/22$, or for a film with ISO speed other than 100. The fine red-dotted line indicates the range for a lens with maximum aperture smaller than $f/1.4$, or for a film with ISO speed other than 100.

Metering Range and Shutter/Aperture Coupling Range

The metering range means the range of subject luminance within which the built-in exposure-meter works to control exposure. The shutter/aperture coupling range is that part of the metering range within which shutter-speed and aperture value can be combined for proper exposure control. When you use a 50mm $f/1.4$ normal lens and an ISO 100 film, the metering range is from EV 1 ($f/1.4$ -1 sec. or $f/2$ -2 sec.) to EV 18 ($f/16$ - $1/1000$ sec. or $f/22$ - $1/500$ sec.). The range varies according to film speed (ISO). The variation of the metering range is shown by slanting lines which shift with ISO ratings. The frame in the center shows the meter and shutter/aperture control coupling range.

EV (Exposure Value)

EV represents a combination of the shutter-speed and the lens aperture which is determined by the film speed (ISO) and the brightness of the subject.

ATTACHING STRAP; SOFT CASE

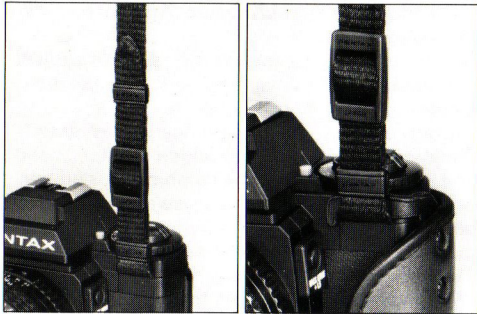

- To attach the strap to the camera, first pass the end of the strap through the strap lug on the camera, fold it back, then pass it through the strap ring, and through the strap clasp and the last ring. The strap end may be passed through the inside or outside of the clasp.

- The soft case comprises of a back cover and a front cover.

- Remove the front cover from the back cover. Put the camera in the back cover and put both case hooks around the camera's strap eyelets. The camera is now held securely in place.



DIOPTRER CORRECTION, MOUNT ADAPTER K

Diopter correction lenses which fit the eyepiece on your camera are available. If you find it difficult to see the viewfinder image clearly, choose any one of the eight Correction Lenses M of -5, -4, -3, -2, -1, +1, +2, +3 diopters. Slide it into the eyepiece's accessory groove. Before buying one, try it for yourself with the lens attached to your camera.

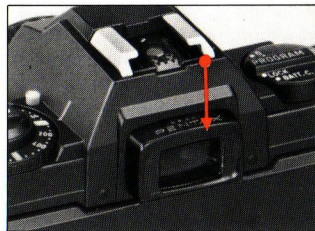

Mount Adaptor K

If you want to use any conventional Takumar screw-mount lens on your camera it is possible by placing an optional accessory called the Mount Adapter K between the camera body and the lens. However, please note the following conditions when actually taking pictures:

- Automatic diaphragm does not work due to difference in the coupling system.
- Stop-down metering must be made.
- Automatic aperture setting with a Pentax dedicated flash is not workable.



PRECAUTIONS ON ACCESSORIES

- When using the accessories that fit between the camera and lens, such as Auto Bellows, Extension Tubes, Microscope Adapter, etc., set the camera to the Aperture-priority AE mode.
- To check the viewfinder displays such as the shutter speed, etc. with the Cable Switch A or Cable Release on your camera, depress the shutter button partially with your finger.



PRECAUTIONS ON BATTERIES

- Incorrect usage of batteries causes such hazards as leakage, heating or explosions. Polarity markings should be carefully checked while inserting batteries. If either battery is erroneously inserted, unexpected mishap may occur.
- Replace both batteries at the same time. Do not mix battery brands and types, or old batteries with new batteries.
- When not using the camera for long periods of time, you should remove batteries from the camera. Old batteries are apt to leak and damage the battery compartment. Always keep batteries out of the reach of children.
- Never break, recharge, or throw used batteries into fire as a precaution against explosions.
- Batteries should be kept warm in cold climates to prevent lowering of performance.
- Keep spare batteries on hand for convenience in photographing outdoors or while traveling, etc.
- When keeping the camera in a bag or case, lock the shutter release button to avoid the unnecessary consumption of battery power that may result from accidentally releasing the shutter.
- Making a long exposure using the B setting consumes a considerable amount of battery power. For example, 24-hour continuous long exposure will completely deplete one set of fresh Alkaline batteries in normal temperatures.

SPECIFICATIONS

Type:	TTL (Through-The-Lens) automatic exposure 35mm SLR with built-in film winder.
Film:	35mm film, 24 x 36mm. Automatic film speed setting from ISO 25 to 1600 (in 1/3 step) with DX-coded film. Manual film speed setting from ISO 25 to 1600 (in 1/3 step).
Lens Mount:	Pentax KA bayonet mount.
Exposure Modes:	Programmed AE, Aperture-Priority AE, Programmed Auto Flash.
Shutter:	Seiko MFC E6 vertical-run focal plane shutter. Electro-magnetic shutter release with shutter release lock. Electronically-controlled speeds from 2 to 1/1000 sec.; 1/60 sec. and B (bulb) settings.
Viewfinder:	Silver-coated pentaprism finder with split-image/microprism/matte focusing screen. Shows 92% of the picture area at 0.82X magnification with 50mm lens at infinity. -1 Diopter eyepiece.
Exposure Indication:	LED indicators for: " " (flash ready), "P" (Programmed AE mode), and 6 shutter speeds (green LED for "1000" to "60"; yellow for "30"). Warning for exposure setting outside aperture/shutter-speed coupling range ("1000" or "30" LED blinks at 8Hz; PCV sound at over "1000"). Camera-shake warning for shutter speeds under 1/45 sec. ("30" blinks at 2Hz. Shutter speed setting error ("P" flickers at 8Hz).
Flash Synchronization:	Hotshoe (X-sync contact, dedicated flash contacts), X-sync at 1/60 sec.
Self-Timer:	Electronically-controlled 12-second delay timer. Delay time indicated by blinking LED and PCV sound. Possible to cancel at any time. Timer activated with shutter release button.
Mirror:	Back-swing type instant return mirror.

Film Loading:	Automatic film loading system; film automatically advanced to the first frame.
Film Winding:	Automatic film winding. Consecutive shooting possible at approx. 1.5 fps. At film end, red LED on grip lights, motor automatically switched off.
Exposure Counter:	Additive type, automatic resetting. Automatically sets shutter-speed at 1/1000 sec. up to "0" frame on the exposure counter.
Film Rewind:	Crank type.
Exposure Metering:	Open aperture, TTL center-weighted, average area metering system with GPD cell.
Metering Range:	EV 1 (f/1.4, 1 sec.) ~ EV 18 (f/16, 1/1000 sec.) with 50mm f/1.4 lens and ISO 100 film.
Exposure Compensation:	+1.5EV exposure compensation button.
Power Source:	Two "AA"-size alkaline batteries.
Battery Check:	Set mode selector dial to "BATT.C": Red LED on grip lights to indicate sufficient power.
Body Size & Weight:	152.5(W) x 87.5(H) x 50.5(D)mm (5.3" x 3.4" x 2.0"); 530g (18.7 oz.) without batteries.

TAKING CARE OF YOUR CAMERA

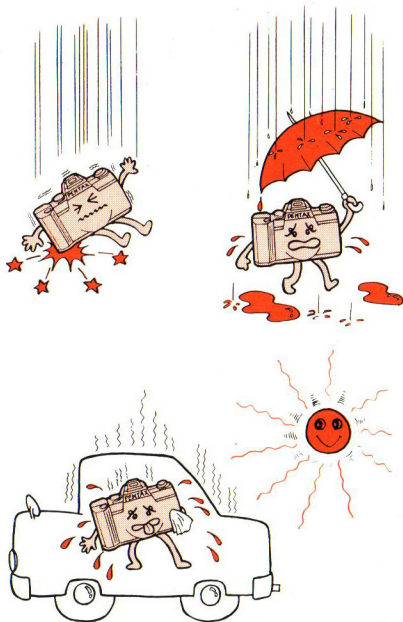

Your Pentax camera is a sophisticated, precision instrument built to give long-lasting, reliable service. It will serve you well if you treat it right, with proper handling and reasonable care. The major causes of damage are:

1. Dropping or banging the camera against immovable objects, which can damage the camera in many ways.
2. Water damage, particularly if the camera is submerged in salt water. Cameras are not water-proof! They must be protected from salt spray at the beach, splashing of any kind, and shielded from the rain. If your camera does get soaked, wipe it dry immediately and rush it to a Pentax service center.
3. Dirt and sand can cause serious damage to the shutter and other moving parts of the camera. Your camera needs periodic cleaning to keep it operating properly. To remove dirt and dust, you need lens-cleaning fluid, lens-cleaning tissues, bulb-type ear syringe, camel's hair brush, etc. Never use a solvent such as thinner or alcohol.
4. One set of batteries should last a year with

average use without using flash, at normal temperatures. Humidity and temperature extremes should be avoided. Keep your camera out of direct sunlight, car trunks, and glove compartments. Shooting outdoors in winter presents a problem since batteries won't function if they get too cold. In cold weather carry your camera under your coat or jacket to keep the batteries warm. The temperatures at which this camera should function properly are approx. $50^{\circ} \sim -10^{\circ}\text{C}$. Sudden changes in temperature will often cause moisture to condense inside or outside your camera. This is a possible source of rust, which may be extremely harmful to the mechanism. Furthermore, if the camera is taken from a warm temperature to a sub-freezing one, further damage may result from the formation of icelets. Thus, sudden temperature changes should be avoided as much as possible. As a guide, a temperature change of 10°C should be allowed to take place gradually over a period of at least 30 minutes. If this is not possible, keeping the camera in its case or bag will help somewhat in minimizing the effects of a rapid temperature change.

5. Vibration experienced when you are traveling in a car, plane, or ship, can cause screws to loosen. To minimize this problem use foam-rubber padding about one inch thick to line the bottom of your camera bag.

WARRANTY POLICY

All Pentax cameras purchased through authorized bona fide photographic distribution channels are guaranteed against defects of material or workmanship for a period of twelve months from date of purchase. Service will be rendered and defective parts will be replaced without cost to you within that period, provided the equipment has not been abused, altered, or operated contrary to instruction. Because the tolerances, quality, and design compatibility of lenses other than Pentax lenses are beyond our control, damage caused by use of such lenses will not be covered by this warranty policy. The manufacturer or its authorized representatives shall not be liable for any repair or alterations except those made with its written consent and shall not be liable for damages from delay or loss of use or from other indirect or consequential damages of any kind, whether caused by defective material or workmanship or otherwise; and it is expressly agreed that the liability of the manufacturer or its representatives under all guarantees or warranties, whether expressed or implied, is strictly limited to the replacement of parts as hereinbefore provided.

Procedure During 12-month Warranty Period

Any Pentax which proves defective during the 12-month warranty period should be returned to the dealer from whom you purchased the equipment or to the manufacturer. If there is no representative of the manufacturer in your country, send the equipment to the manufacturer, with postage prepaid. In this case, it will take a considerable length of time before the equipment can be returned to you owing to the complicated customs procedures required in Japan in importing and re-exporting photographic equipment. If the equipment is covered by warranty, repairs will be made and parts replaced free of charge, and the equipment will be returned to you upon completion of servicing. If the equipment is not covered by warranty, regular charges of the manufacturer or of its representatives will apply. Shipping charges are to be borne by the owner. If your Pentax was purchased outside of the country where you wish to have serviced during the warranty period, regular handling and servicing fees may be charged by the manufacturer's representatives in that country. Notwithstanding this, your Pentax returned to the manufacturer will be serviced

free of charge according to this procedure and warranty policy. In any case, however, shipping charges and customs clearance fees are to be borne by the sender. To prove the date of your purchase when required, please keep the receipts or bills covering the purchase of your equipment for at least a year. Before sending your equipment for servicing, please make sure that you are sending it to the manufacturer's authorized representatives or their accredited repair shops, unless you are sending it directly to the manufacturer. Always obtain a quotation of the service charge, and only after you accept the quoted service charge, instruct the service station to proceed with the servicing.

This warranty policy does not apply to Pentax products purchased in the U.S.A., U.K., or Canada. The local warranty policies available from Pentax distributors in those countries supersede this warranty policy.

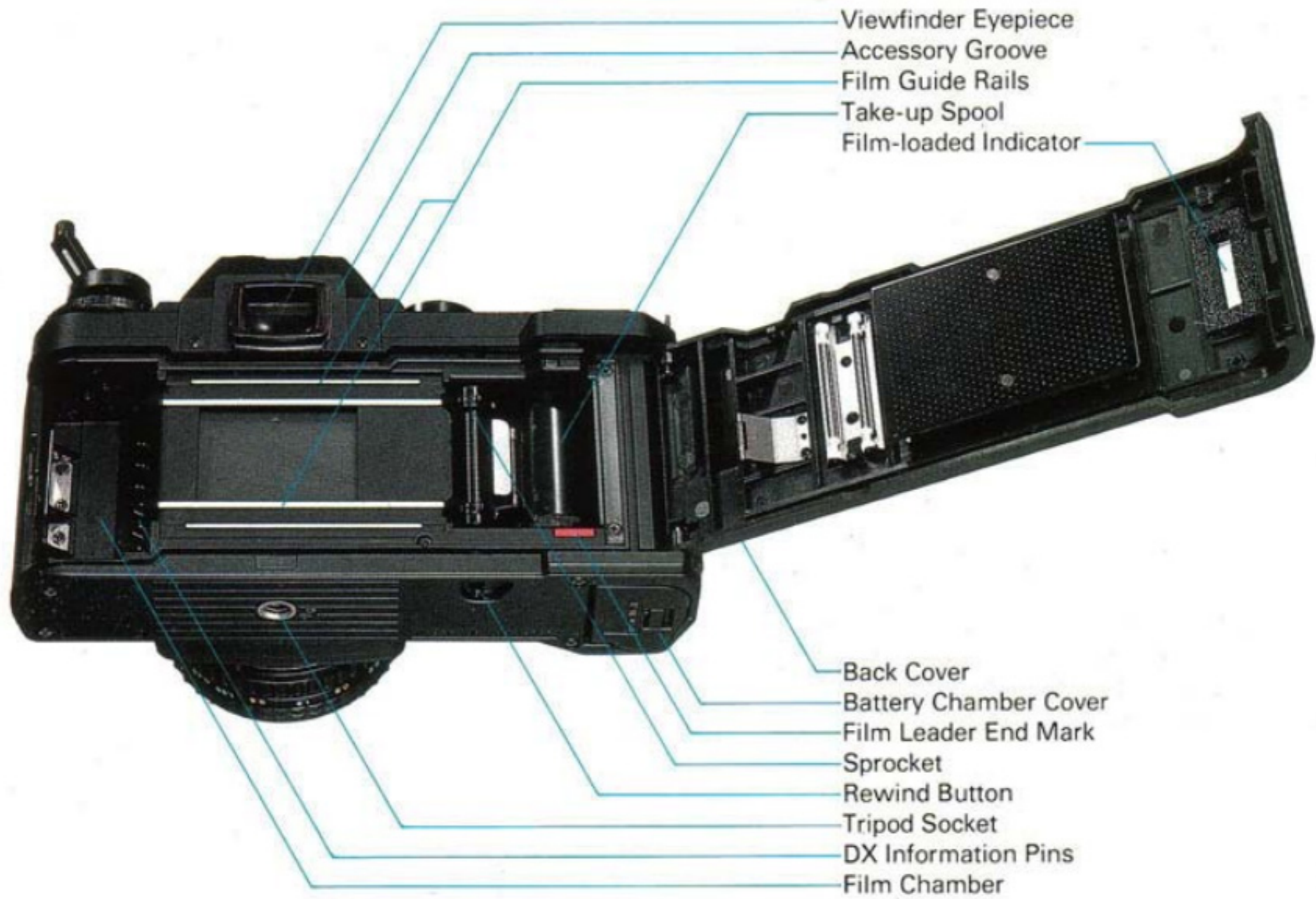



"SMILING PUMPKINS" by K. Chiwata, Pentax Corporation



Asahi Optical Co., Ltd. C.P.O. 895, Tokyo 100-91, JAPAN
Pentax Europe n.v. Weiveldlaan 3-5, 1930 Zaventem Zuid-7, BELGIUM
Pentax Handelsgesellschaft mbH Postfach 54 0169, 2000 Hamburg 54, WEST GERMANY
Pentax U.K. Limited Pentax House, South Hill Avenue, South Harrow, Middlesex HA2 OLT, U.K.
Pentax France S.A. Z.I. Argenteuil, 12, Rue Ambroise-Croizat, 95100 Argenteuil, FRANCE
Pentax (Schweiz) AG Industriestrasse 2, 8305 Dietlikon ZH, SWITZERLAND
Pentax Svenska AB Box 650, S-751 27 Uppsala, SWEDEN
Pentax Nederland Spinveld 25, 4815 HR Breda, THE NETHERLANDS
Pentax Norge A/S Stenersgt. 18, Oslo 1, NORWAY
Pentax Corporation 35 Inverness Drive East, Englewood, Colorado 80112, U.S.A.
Pentax Canada Inc. 1760 West 3rd Avenue, Vancouver, B.C. V6J 1K5, CANADA
Asahi Optical Brasileira Ind. e Com. Ltda. Rue Capitão Antonio Rosa 376, Sala 121 Ed. PBK, São Paulo, BRASIL